

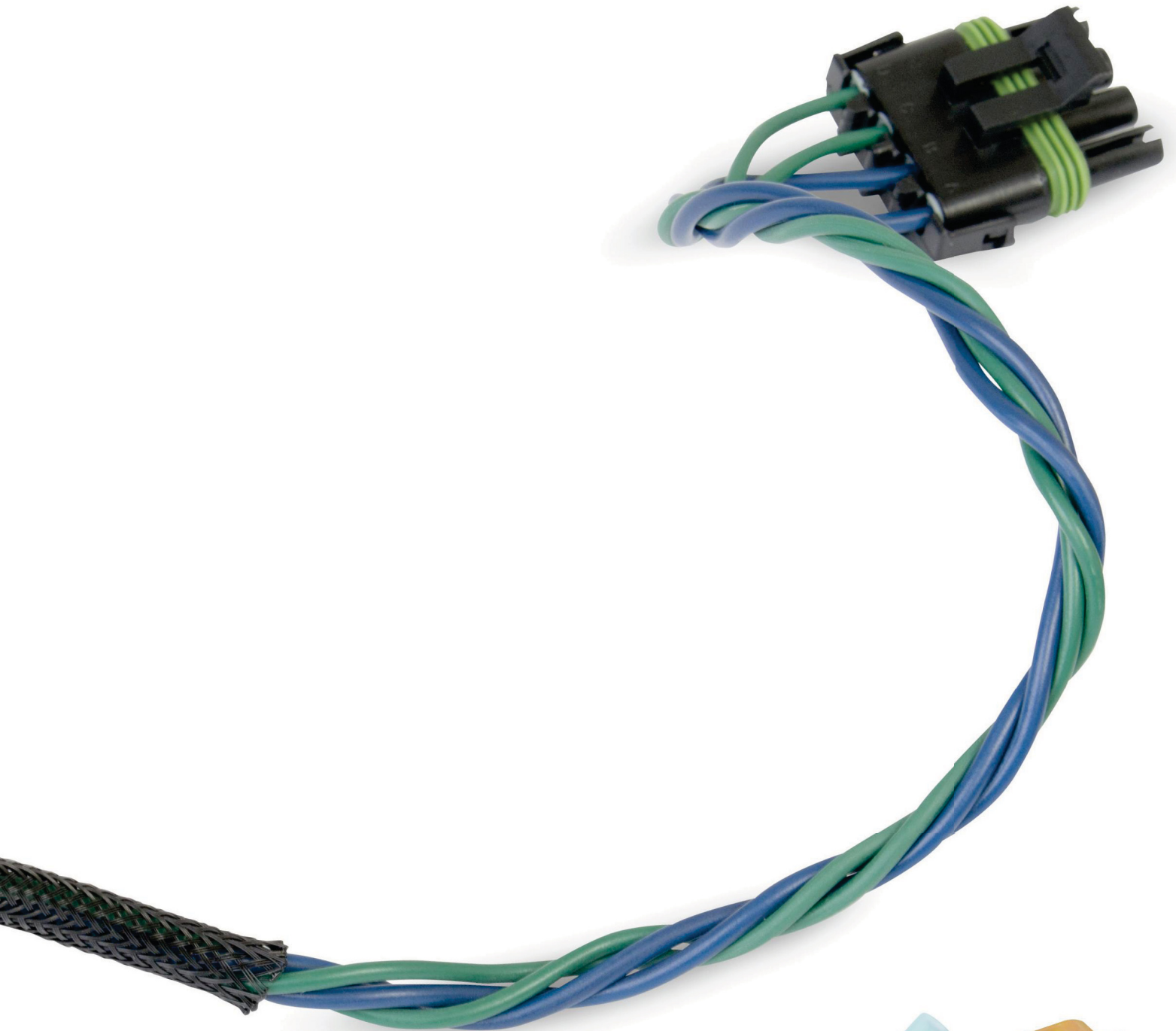

YOUR DIRECT SOURCE

for professional 12V electrical and transportation supplies



Free
Shipping
Over \$99

1-2 Day
Delivery

No Minimum
Order Size

Efficient
Global
Fulfillment

NEW PRODUCTS 2015



**Contura III Carling
Rocker Switches**

PG 110
20073432

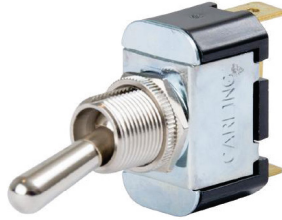

**F-Series Carling
Toggle Switches**

PG 93
20073022

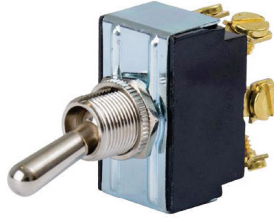

**G-Series Carling
Toggle Switches**

PG 94
20073025



MCase Fuses

PG 259
79630



Mini Indicator Fuses

PG 142
77403



Micro Fuses

PG 142
78930



Micro3 Fuses

PG 142
78932



MAXI Indicator Fuses

PG 142
78520



NEW PRODUCTS

2015

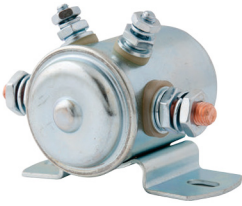

12 Volt Solenoid Switch

PG 154
8000370



3 Point Cable Crimper

PG 289
990017



1/4" Drive Extendable Flexible Head Ratchet

PG 285
9901405



Push Button Thermal Circuit Breakers

PG 136
70545



Table Top Wire Rack & Terminal Kite

PG 296
9900815



Automotive Electrician's Tote

PG 296
9900800



Class II LED Severe Vibration Beacon

PG 241
ECCOEB7930A



Heat Shrink Fabric Loom

PG 37
1732



CONTENTS

2014

wire and cable..... 9-24



primary wire	10-11
parallel wire	12
brake cable	13
speaker wire	13
trailer cable	14
cross-link wire	15-17
RVI wire	18
tinned wire and cable	19-20
battery and welding cable	21-22
power cord & plugs	23-24

cable ties & wire fasteners 25-31



standard ties	25
heavy-duty ties	25
colored ties	26
cable tie tools	26
precision ties	26
releasable ties	27
mounting ties	28
specialty ties	29
cable tie bases	29-30
nylon clamps	31
body clips	31

loom & loom clamps 32-40



slit loom	32
hi-temp loom	33
loom insertion tools	33
flame retardant loom	34
asphalt loom	35
hi-temp braided sleeving	35
expandable sleeving	36
heat shrink loom	37
loom clamps	38-39
strain relief	40

shrink tube & tape 41-47



PVC & single wall	41
dual wall	42
triple wall	42
translucent & clear	43
shrink tube kits	43-44
tape	45-47

clamps & grommets 48-54



hose clamps	48
constant torque clamps	49
muffler clamps	49
loom clamps	50-51
nylon clamps	51
grommets	52-54

terminals..... 55-72



bullet	57
butt	58-60
push-on	61-63
ring	64-65
spade	66-67
specialty	68
terminal kits	69-72

wire connectors..... 73-82



wire connectors	73-74
closed end connectors	74
quick splices	75
t-taps	76
AT™ harsh environment	77
weather packs	78
packard connectors	79
Metri®-Pack connectors	80-81
Weather Pack & Metri®-Pack tools	82

kits 83-92



shrink tube kits	83-84
terminal kits	84-85
shrink tube terminal kits	85-89
fuse kits	89-90
weather pack kits	91
AT™ connector kit	91
battery kits	92
brake line kits	93

switches 93-131



toggle switches	93-98
toggle switch accessories	99-100
high-amp switches	100-101
medium duty switches	102
plastic toggle switches	103-107
full size rocker switches	108-109
rocker switches	110-112
appliance size rocker switches	112-113
round hole mounting rocker switches	114-120
switch panels	121
push-button/specialty switches	122-123
battery disconnect switches	124-129
indicator lights	130
canopy switches	131

circuit breakers..... 132-140



stud type breakers	133-134
blade style breakers	135-136
push button breakers	136
mid-range breakers	137
hi-amp breakers	138-139
marine rated breakers	140

fuse & fuse accessories..... 141-151



AGC® fuses	141
ATC®/ATO® fuses	141
Maxi™ fuses	141
Mini™ fuses	142
Micro fuses	142
MCase fuses	143
Mega® fuses	143
cartridge fuses	143
fuse kits	144
fuse holders	145-146
min-fuse blocks	147-148
fuse blocks	149-150
fuse panels	151

INDUSTRY INDEX

automotive



wire	10, 21
loom	32 - 37
shrink tube	41-42
terminals	55-72
toggle switches	93-98
circuit breakers	132-140
fuses	141-143
relays	182-154
brake lines	168

truck/trailer



cable	14
cable ties	25
terminals	55-72
loom	32 - 37
loom clamps	39
weather packs	78
hi-amp breakers	138-139
junction blocks	156
trailer connectors	214-226
lights	227-265

marine



tinned wire	19 - 20
stainless steel cable ties	29
flame retardant loom	34
dual wall heat shrink	42
terminals	55-72
rocker switch	108-112
marine breakers	140
fuse holders	145-146
flood lights	253
tinned lugs	273-274

relay & power distribution... 152-157



- relays 152-154
- solenoids 154
- distribution blocks 155-156
- buss bars 156
- flashers 157

gauges 158-163



- electrical gauges 159
- mechanical gauges 160
- industrial gauges 161
- hourmeters 162
- accessories 163

safety products 164-166



- glasses & ear plugs 164
- gloves 165
- safety tape 166
- cleaning 166

service supplies 167-173



- hoses 167
- brake lines 168
- wipers 169
- car covers 170
- paint 171-173

chemicals 174-177



- cleaners 174
- lubricants 175
- undercoating 175
- adhesives 176-177

Curt® Hitches 178-213



- towing information 178-183
- ball mounts 184-190
- trailer balls 191-192
- security 193-194
- accessories 194-197
- gooseneck hitches 198-201
- specialized towing 202-204
- replacement hardware 205-209
- bike racks 210-211
- cargo carriers & straps 212-213

trailer connector 214-226



- molded connectors 215-216
- weather & metri pack connectors 217-220
- brake controllers 220-221
- trailer adapters 222
- trailer connectors 223-226
- aux power outlets 226

lighting 227-265



- LED lights 227-230
- incandescent lights 231-234
- license lights 234
- grommets 235
- pigtails 236
- replacement bulbs 237-238
- beacons 239-242
- mini bars 243-244
- micro strobes 245
- LED directional 240 - 242
- warning lights 246-248
- work lights 250-254
- back-up alarms 254-261
- video cameras 262-265

battery cables & accessories 266-284



- battery cables 266-267
- battery booster & misc 268
- battery terminals 269-271
- battery lugs 272-276
- accessories 277-279
- power cable links 280
- battery clamps 281
- battery maintainers 281-283
- kits & cleaner 284

hand tools 285-297



- ratchets 285
- telescoping props 286
- battery cleaners 287
- standard crimpers 288
- ratchet crimpers 287-289
- heavy-duty large gauge crimpers 289
- wire strippers 290-291
- heat guns 291
- Circuit Alert™ hand tools 292-293
- flashlights 293-294
- extension cords 294
- kit boxes 294-295
- wire pulling & racks 296-297

specialty testers 298-313



- voltage testers 298
- memory savers 299
- insulation testers 299-300
- thermometers 300
- continuity testers 301-302
- outlet testers 303-304
- multimeters 306-309
- datacon testers 310-313

rv accessories 314-324



- cordsets 314
- adapters 315
- power outlets 316
- 5th wheel hitches 317-319
- trays 320-322
- steps 322
- accessories 323-324

recreation



- parallel 12
- flame retardant loom 34
- tape 45-47
- terminals 55-72
- rocker switches 108-112
- fuse blocks 149-150
- hoses 167-168
- trailer connectors 214-226
- RV accessories 314-324

construction



- duplex wire 13
- flame retardant loom 34
- terminals 55-72
- toggle switches 94-107
- circuit breakers 126-134
- junction blocks 132-140
- hour meters 162
- lighting 227-265

emergency



- TXL, GXL, SXL wire 15-17
- cable ties 25-31
- loom 32-37
- terminals 55-72
- AT™ connectors 77
- toggle switches 94-107
- hi-amp circuit breakers 132-133
- distribution blocks ... 138-139
- lighting 227-265

Del City

Del City has been providing excellent service and world-class electrical tools and supplies to companies just like yours since 1947. We take pride in our credibility, the relationships that we build and our reputation that distinguishes us from our competitors. This catalog is designed to provide you with answers to most of your product questions—but we welcome your comments and suggestions!



phone

toll free 800.654.4757



online

www.delcity.net



24 hour fax

toll free 800.431.1293



email

info@delcity.net



mail

N85 W12545 Westbrook Crossing
Menomonee Falls, WI 53051

delcity.net

For the ultimate 24-hour supply line, go to delcity.net and order any Del City product securely online. The site showcases new products, and includes forms to quickly open an account with Del City, order additional catalogs, or contact us via email.

ACCOUNT AREA Personalized information shows past orders and the ability to repeat orders

SEARCH Easy product search by name or item number

QUICK ORDER Enter in part number in form for quick checkout

EMAIL OFFERS Sign-up to receive special email-only deals, offers and new products

SAVE 30-day deals and special offers

ONLINE CATALOG View interactive catalog with direct links to product ordering

The screenshot shows the Del City website interface. At the top, there's a navigation bar with links for 'Sign In', 'Order Status', 'Request a Quote', 'Help', 'Our Catalog', 'SO FREE', 'FLAT RATE CANADA', and 'SAME DAY SHIPPING'. Below this is a search bar and a 'Buy of the Month' section. The main content area features a large banner for 'NEW Fusion Battery Terminals' with a 'SHOP NEW TERMINALS' button. Below the banner, there's a description of Del City's products and a list of 'Some Items You May Be Interested In' with 'ADD' buttons. The footer includes 'Our Shipping Promise', 'Consent With Us', 'Our Associations', 'Email Only Offers', 'About Us', 'Resources', 'Help', and 'Information'.

Current Pricing

Our customers asked and Del City listened. Del City is proud to introduce a simple and easy new way to find the most current price on any product listed in the catalog. Simply scan the QR code below, type the part number and hit enter. The most up-to-date price will be returned. Want to use the desktop version, go to www.delcity.net/catalogpriceing.



scan to check price

ENLARGED PRODUCT SEARCH BAR Don't strain your eyes trying to see what is being typed. Large display search bar allows for easy viewing of what is being typed.

PRODUCT DETAIL Find pricing, minimum order quantity, product information and stock availability.



Find code in the upper corner of each page

Mobile

Enjoy shopping for all of your favorite Del City products right from your phone. Del City's mobile website allows customers to easily find products, learn detailed product information and easily shop.



scan to shop on the go

EASY NAVIGATION Experience fast and friendly mobile navigation with crisp product images.

EASY CHECKOUT When you're finished shopping, a simple two-step process completes your order.

PRODUCT INFORMATION Detailed product information available at your fingertips.



Interactive Catalog

Del City's interactive catalog is an electronic version of Del City's print catalog. Listed within the interactive catalog are thousands of electrical and automotive products, along with product images, descriptions and pricing.



ORDERING Catalog items link directly to the item detail page for ease of ordering, to your shopping cart while browsing the interactive catalog.

SEARCH Fully searchable content allows users to easily find readily available information.

EASE OF USE Ability to turn pages with your mouse and rollover part numbers to see product images and price breaks.



scan to use interactive catalog

Official Partners

For the past 65 years, Del City has always put our customers at the forefront of what we do, providing superior customer service, satisfaction and product quality. It is from these core ideals and values that Del City looks to like-minded businesses and organizations to partner with. West Coast Customs and US Touring Car Championship are just two businesses and organizations that we have chosen as partners. They are leaders in their respective industries who share the same passion for customer satisfaction as we do.



ultimate customization

Del City is proud to partner with West Coast Customs® for their electrical automotive supplies. West Coast Customs® represents the very best in automotive, trucks, motorcycle and other transportation customizations for sports stars, celebrities and corporations. They were the first customization shop in TV's "Pimp My Ride" and are now the stars of their own hit show, "Inside West Coast Customs."

"We are thrilled about the partnership. The West Coast Customs (WCC) team knows they can count on Del City for quality components delivered quickly. To ensure each vehicle build lives up to WCC standards, we only use the best and Del City exceeds our expectations."

– Ryan Friedlinghaus, Owner, West Coast Customs



auto racing

Del City is proud to partner with US Touring Car Championship for their electrical automotive and transportation supplies. The US Touring Car Championship is a series that is geared for the racing enthusiast. They limit the amount of engine, suspension and transmission modifications that teams can make to their standard stock cars, making the series very popular among drivers and race fans alike.

"Del City is the Nitto Tires US Touring Car Championship's #1 source for shop supplies because we know we can get a wide range of products at great prices. Del City's selection can't be beat and the teams love the free shipping on orders over \$99."

– Ali Arsham, Director of US Touring Car Championship

wire gauge chart

12 volt system		total length of wire in circuit from power supply to accessory									
amp (approx.)	candle power	2.5' gauge	5' gauge	10' gauge	20' gauge	30' gauge	40' gauge	50' gauge	60' gauge	80' gauge	100' gauge
1	6	20	20	20	20	20	20	20	20	20	18
1.5	10	20	20	20	20	20	20	20	20	20	18
2	16	20	20	20	20	20	20	18	18	16	16
3	24	20	20	20	20	20	18	18	16	16	14
4	30	20	20	20	20	18	16	16	16	14	12
5	40	20	20	20	18	18	16	14	14	12	12
6	50	20	20	20	18	16	16	14	14	12	12
7	60	20	20	20	18	16	14	14	12	12	10
8	70	20	20	20	16	16	14	12	12	10	10
10	80	20	20	18	16	14	12	12	12	10	10
11	90	20	20	18	16	14	12	12	10	10	8
12	100	20	20	18	16	14	12	12	10	10	8
15	120	20	20	18	14	12	12	10	10	8	8
18	140	20	20	16	14	12	10	10	8	8	8
20	160	20	18	16	12	12	10	10	8	8	6
22	180	20	18	16	12	10	10	8	8	8	6
24	200	20	18	16	12	10	10	8	8	6	6
36	-	20	16	14	10	8	8	8	6	6	4
50	-	18	16	12	1	8	6	6	4	4	2
100	-	14	12	10	6	4	4	2	2	1	0
150	-	14	10	8	4	2	2	1	0	00	00
200	-	12	8	6	4	2	1	0	00	000	0000



Scan for pricing or go to www.delcity.net/catalogpricing

Note: This chart is based on a 10% maximum voltage drop. For 5% voltage drop, use double the measured wire length. When mechanical strength is a factor, use next larger wire gauge.

primary wiring amperage guide:
amperage based on typical 12 volt system

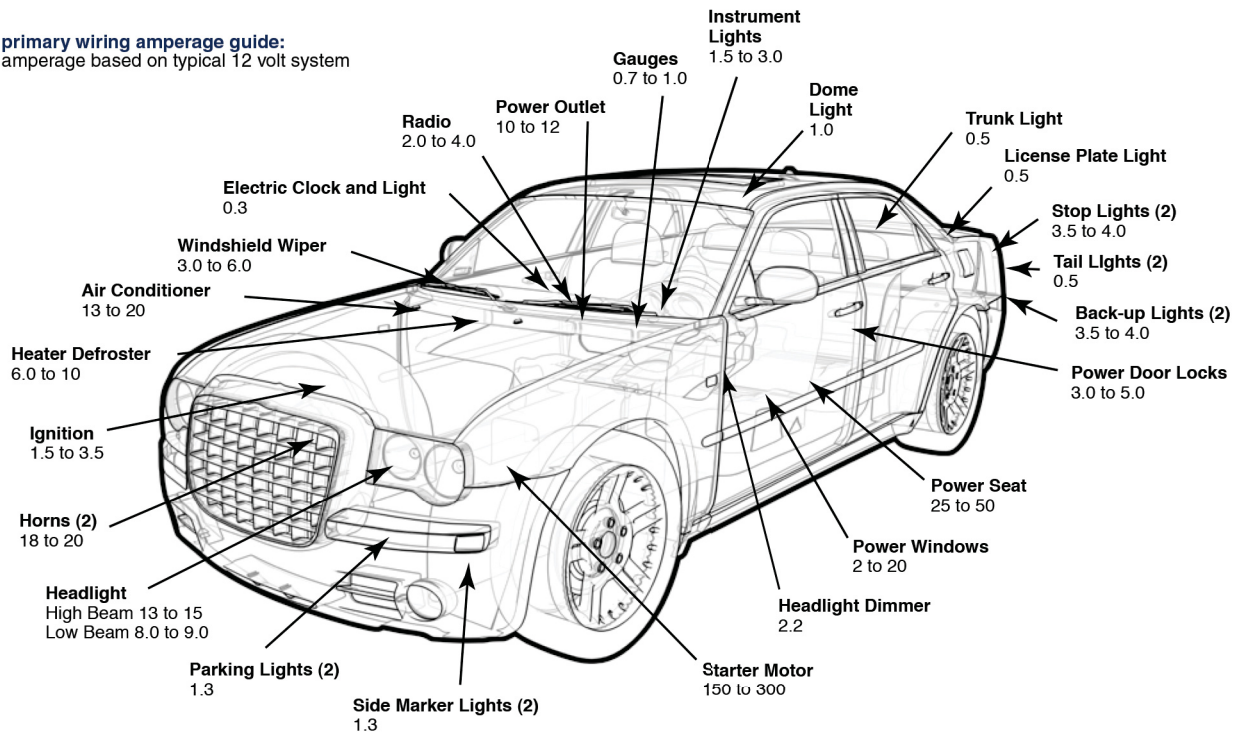



Scan for pricing or go to www.delcity.net/catalogpricing



3 1/2" plastic spool



6 1/2" & 10 1/2" plastic spool



15 1/2" wooden reel

Primary Wire

This single conductor copper stranded polyvinyl chloride (PVC) insulated primary wire is standard for original equipment and replacement applications. It can be used in automotive, truck, trailer, marine, bus, construction equipment and tractors. Its smooth surface is ideal for pulling through loom or conduit. Highly resistant to grease, oil and acids. Meets or exceeds SAE specification J1128. The insulation operates optimally between the temperatures of -40°C to 105°C (-40°F to 221°F). Rated to 60V DC. **Please specify color with a 2-digit suffix; see special note box below.**



20 gauge*

part no.	length/reel	lbs per spool	spool diameter
11201	100'	1	3 1/2"
11205	500'	4	6 1/2"
11200	1000'	7	6 1/2"
11208	6000'	41	15 1/2"

Only available in: red, white, blue, green, black, yellow & brown

12 gauge

part no.	length/reel	lbs per spool	spool diameter
11121	100'	3	5"
11125	500'	13	6 1/2"
11120	1000'	26	10 1/2"
11127	1500'	38	10 1/2"
11128	4000'	106	15 1/2"

18 gauge

part no.	length/reel	lbs per spool	spool diameter
11181	100'	1	3 1/2"
11185	500'	5	10 1/2"
11180	1000'	7	10 1/2"
11187	3000'	27	10 1/2"
11188	6000'	58	15 1/2"

10 gauge*

part no.	length/reel	lbs per spool	spool diameter
11101	100'	5	5"
11105	500'	21	10 1/2"
11107	1000'	39	10 1/2"
11108	3000'	124	15 1/2"

* Only available in: red, white, blue, green, black, yellow & brown

16 gauge

part no.	length/reel	lbs per spool	spool diameter
11161	100'	2	3 1/2"
11165	500'	6	6 1/2"
11160	1000'	12	6 1/2"
11167	2500'	30	10 1/2"
11168	5000'	63	15 1/2"

8 gauge*

part no.	length/reel	lbs per spool	spool diameter
11081	100'	7	6 1/2"
11087	500'	30	10 1/2"
11088	1000'	66	15 1/2"

* Only available in: red, white, & black.

14 gauge

part no.	length/reel	lbs per spool	spool diameter
11141	100'	2	3 1/2"
11145	500'	9	6 1/2"
11140	1000'	18	10 1/2"
11147	2000'	32	10 1/2"
11148	4000'	70	15 1/2"

specification guide

SAE size	conductor stranding	wall mils*	nominal O.D.
20 ga	7/0.0126	0.023"	0.084"
18 ga	16/0.010	0.023"	0.094"
16 ga	19/0.0112	0.023"	0.103"
14 ga	19/0.0140	0.023"	0.117"
12 ga	19/0.0177	0.026"	0.142"
10 ga	19/0.0223	0.031"	0.168"
8 ga	19/0.0281	0.037"	0.208"

* wall mils = insulation thickness

Special Note

Please specify a color by applying a 2-digit suffix to the part number (corresponding to your color preference):

- | | |
|------------|-------------|
| 01 – red | 06 – yellow |
| 02 – white | 07 – brown |
| 03 – blue | 08 – gray |
| 04 – green | 09 – purple |
| 05 – black | 10 – orange |

Example: when ordering a 100-ft spool of 20-Ga wire, 11201, in blue please order **1120103**.

Use With

wire carts
PAGE
297



All spool weights (lbs per spool) are approximate.



2 1/2" plastic spool

Thrifty Spools 

Thrifty spools are standard packages of primary wire in graduated lengths so that each spool has the same value and sells for the same price. Perfect for small jobs or resale. Meets or exceeds SAE specification J1128. Thrifty spools are sold per each spool. The insulation operates optimally between the temperatures of -40°C to 105°C (-40°F to 221°F). Rated to 60V DC.



Scan for pricing or go to www.delcity.net/catalogpricing

18 gauge / 45-ft		16 gauge / 35-ft		14 gauge / 25-ft	
part no.	color	part no.	color	part no.	color
8181	red	8161	red	8141	red
8182	white	8162	white	8142	white
8183	blue	8163	blue	8143	blue
8184	green	8164	green	8144	green
8185	black	8165	black	8145	black
8186	yellow	8166	yellow	8146	yellow
8187	brown	8167	brown	8147	brown

12 gauge / 15-ft		10 gauge / 10-ft	
part no.	color	part no.	color
8121DL	red	8101	red
8125	black	8105	black

Use With
weather packs
PAGE 78



6 1/2" plastic spool

Ripcord

Ripcord is parallel wire suitable for alarm systems or light extension cords. The PVC insulation is coded for easy identification; Type SPT-1. The plastic insulation is 1/32" thick. Rated 300V RMS. The insulation operates optimally between the temperatures of -20°C to 60°C (-4°F to 140°F).



part no.	gauge/ conductors	outside diameter	standard spool size	lbs per spool	color	spool diam.
218102	18-2	.112" x .210"	250'	5	white	6-1/2
218105	18-2	.112" x .210"	250'	5	black	6-1/2
218107	18-2	.112" x .210"	250'	5	brown	6-1/2
21814002	18-2	.112" x .210"	5000'	101	white	-
21814005	18-2	.112" x .210"	5000'	101	black	-
21814007	18-2	.112" x .210"	5000'	101	brown	-



6 1/2" plastic spool

Ground Strap

This wire is manufactured from copper material with a tinned coating for added corrosion resistance. The flexible, flat cable is designed to fit into tight places and its durability allows for use in a multitude of grounding applications. 30 AWG stranding. ASTM B33 compliance.



part no.	gauge	length/spool	strap width	strap thickness	lbs per spool
50442	4	25'	7/8"	3/16"	4
50401	4	100'	7/8"	3/16"	16
5040140	4	500'	7/8"	3/16"	95

All spool weights (lbs per spool) are approximate.

wire & cable



Scan for pricing or go to www.delcity.net/catalogpricing



5", 6½" and 10½" plastic spool

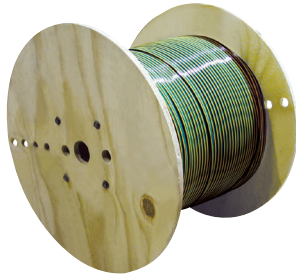

11½", 15½" and 20½" wooden reel

General Purpose Parallel Wire

Parallel wire is constructed of standard-wall; polyvinyl chloride (PVC) insulated wires that are extruded in two, three or four side-by-side configurations. It is designed to remain bonded together, but the wires can be easily separated on the ends for termination or final connection. Parallel wire is ideal for wiring trailer lights, small trailers and other applications where economical wire is required. Meets SAE specification J1128. Temperature rating: 90°C (194°F). Rated to 50V DC.



18 gauge / 2 conductor

part no.	reel size	lbs per spool	spool diameter
82181DL	100'	2	3½"
82183DL	250'	5	6½"
82185	500'	10	10½"
82187	4000'	70	15½"
82188	8000'	135	15½"

16 gauge / 4 conductor

part no.	reel size	lbs per spool	spool diameter
84161	100'	5	6½"
84163	250'	12	10½"
84165	500'	23	10½"
84167	2000'	89	15½"
84168	4000'	186	20½"

18 gauge / 3 conductor

part no.	reel size	lbs per spool	spool diameter
83181DL	100'	3	3½"
83183	250'	7	5"
83185	500'	13	10½"
83187	2000'	48	10½"
83188DL	4000'	96	15½"

14 gauge / 2 conductor

part no.	reel size	lbs per spool	spool diameter
82141	100'	4	6½"
82143	250'	9	6½"
82145	500'	17	10½"
82147	2250'	86	11½"
82148	4500'	172	20½"

18 gauge / 4 conductor

part no.	reel size	lbs per spool	spool diameter
84181	100'	4	6½"
84183	250'	9	6½"
84185	500'	17	10½"
84187	2000'	64	11½"
84188DL	4000'	128	15½"

14 gauge / 3 conductor

part no.	reel size	lbs per spool	spool diameter
83141	100'	6	6½"
83143	250'	13	6½"
83145	500'	26	10½"
83147DL	1750'	87	11½"
83148DL	3500'	174	20½"

16 gauge / 2 conductor

part no.	reel size	lbs per spool	spool diameter
82161	100'	3	3½"
82163DL	250'	6	6½"
82165	500'	13	10½"
82167	3500'	82	11½"
82168	7000'	168	20¾"

14 gauge / 4 conductor

part no.	reel size	lbs per spool	spool diameter
84141	100'	7	6½"
84143	250'	17	10½"
84145	500'	33	10½"
84147	2000'	130	11½"
84148	4000'	260	20½"

Standard Color Configurations:



2 conductor:
brown-red



3 conductor:
brown-yellow-green



4 conductor:
white-brown-yellow-green

16 gauge / 3 conductor

part no.	reel size	lbs per spool	spool diameter
83161	100'	4	6½"
83163DL	250'	9	6½"
83165	500'	18	10½"
83167	2250'	83	11½"
83168	4500'	155	20½"

Use With

truck lamps

PAGES 227-265



All spool weights (lbs per spool) are approximate.



Scan for pricing or go to www.delcity.net/catalogpricing



6½" x 10½" plastic spool

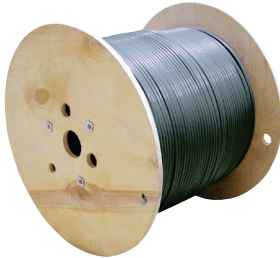

11½" and 15½" wooden reel

Duplex Brake Cable

Duplex brake cable is manufactured with two polyvinyl chloride (PVC) insulated, general purpose primary (GPT) wires laid parallel and covered with a high quality 30 mil PVC jacket. The outer jacketing protects the internal wires from weather and acid effects. It is primarily used for electric brake systems on trailers. Sizes 12 and 10 gauge are recommended for electric brake wire. Color code: black and white with a gray outer jacketing. Internal wire meets SAE J1128 specifications. Temperature rating: 80°C (176°F). Rated to 50V DC.



18 gauge / 2 conductor

part no.	reel size	lbs per spool	spool diameter
62181	100'	3	6½"
62183	250'	7	6½"
62185	500'	14	10½"
62187	1500'	43	15½"
62188	3000'	86	15½"

16 gauge / 2 conductor

part no.	reel size	lbs per spool	spool diameter
62161	100'	4	10½"
62163	250'	9	10½"
62165	500'	18	10½"
62167	1250'	43	10½"
62168	2500'	91	15½"

14 gauge / 2 conductor

part no.	reel size	lbs per spool	spool diameter
62141	100'	5	6½"
62143	250'	11	10½"
62145	500'	25	10½"
62147	1000'	47	10½"
62148	2000'	99	15½"

12 gauge / 2 conductor

part no.	reel size	lbs per spool	spool diameter
62121	100'	7	6½"
62123	250'	18	10½"
62125	500'	35	10½"
62127	1000'	68	11½"
62128	2000'	130	15½"

10 gauge / 2 conductor

part no.	reel size	lbs per spool	spool diameter
62101	100'	11	6½"
62103	250'	27	10½"
62105	500'	53	10½"
62107	750'	82	11½"
62108	1500'	164	15½"

specification guide

SAE size	conductor stranding	wall mils*	wrap O.D.
18-2	16/30	23	.158" x .244"
16-2	19/29	23	.170" x .270"
14-2	19/27	23	.182" x .320"
12-2	19/25	26	.212" x .358"
10-2	19/23	31	.255" x .423"

* wall mils = insulation thickness

Use With

wire cutter / strippers
PAGES 290-291



Speaker Wire

Use this wire for clear sound reproduction and optimal audio output. Positive identification with one tinned copper wire and one bare copper wire, with a clear PVC-coated jacket. Rated to 300V.



3½" plastic spool



18/2 wire size

part no.	spool size	lbs per spool	spool diameter
19181	100'	3	3½"
19185	500'	9	6½"
19180	1000'	17	10½"
19188	5000'	143	15½"

14/2 wire size

part no.	spool size	lbs per spool	spool diameter
19141	100'	4	6½"
19145	500'	16	10½"
19140	1000'	31	10½"
19148	6500'	201	15½"

16/2 wire size

part no.	spool size	lbs per spool	spool diameter
19161	100'	3	3½"
19165	500'	12	6½"
19160	1000'	23	10½"
19168	5000'	165	15½"

12/2 wire size

part no.	spool size	lbs per spool	spool diameter
19121	100'	5	6½"
19125	500'	24	10½"
19128	1000'	49	11½"

All spool weights (lbs per spool) are approximate.



Scan for pricing or go to www.delcity.net/catalogpricing



10 1/2" plastic spool



green ABS cable
15-18-20 wooden spool

Use With

trailer connectors

PAGES 214-226



Trailer Cable

Trailer cable is manufactured with four, six or seven polyvinyl chloride (PVC) insulated, general purpose primary (GPT) wires that are covered by an outer flexible PVC jacketing. Internal wires are single conductor and are color-coded to industry standards. Trailer cable is ideal for wiring trucks and trailers due to durability of the wire to resist cracking, abrasion, oil, grease, acid and weather. Choose seven conductor cable (4-12 Ga/2-10 Ga/1-8 Ga) for ABS applications. Temperature rating: -40°C to 80°C (-40°F to 176°F). Rated to 50V DC.



16 gauge / 4 conductor

part no.	reel size	lbs per spool	spool diameter
91641	100'	9	10 1/2"
91645	500'	45	15 1/2"

14 gauge / 4 conductor

part no.	reel size	lbs per spool	spool diameter
91441	100'	12	10 1/2"
91445	500'	58	15 1/2"

16 gauge / 6 conductor

part no.	reel size	lbs per spool	spool diameter
91661	100'	13	10 1/2"
91665	500'	61	15 1/2"

14 gauge / 6 conductor

part no.	reel size	lbs per spool	spool diameter
91461	100'	16	10 1/2"
91465	500'	80	15 1/2"

12 gauge / 6 conductor

part no.	reel size	lbs per spool	spool diameter
91261	100'	23	10 1/2"
91265	500'	115	17 1/2"

7 conductor (3-12 Ga / 4-14 Ga)

part no.	reel size	lbs per spool	spool diameter
97701	100'	20	10 1/2"
97705	500'	102	15 1/2"

7 conductor (6-12 Ga / 1-10 Ga)

part no.	reel size	lbs per spool	spool diameter
97771DL	100'	31	10 1/2"
97775	500'	156	20"

7 conductor (4-12 Ga / 2-10 Ga / 1-8 Ga)

part no.	reel size	lbs per spool	spool diameter
97721	100'	33	10 1/2"
97725	500'	165	17 1/2"
9772599*	500'	165	17 1/2"

* lime green jacket - ABS cable

INFORMATION

COLOR CODE

4 Conductor
Yellow, Red, Green, Brown

6 Conductor
Yellow, Red, Green, Brown, Blue, Black

7 Conductor
No. 97701 and 97705
#12 White, Brown, Blue;
#14 Black, Yellow, Red, Green

No. 97771DL and 97775
#10 White
#12 Blue, Brown, Green,
Red, Yellow, Black

No. 97721 and 97725
#12 Brown, Black, Yellow,
Green
#10 Red, Blue
#8 White w/black jacket

specification guide

gauge / conductor	conductor / stranding	outer jacket color	approx. diameter
16-4	19 / .0112" BC	black	0.360"
16-6	19 / .0112" BC	black	0.140"
14-4	19 / .0140" BC	black	0.410"
14-6	19 / .0140" BC	black	0.470"
12-6	19 / .0177" BC	black	0.545"
3 #12, 4 #14	19 / .0177" BC 19 / .0140" BC	black	0.500"
1 #10-6 #12	19 / .0281" BC 19 / .0223" BC	black	0.600"
4 #12, 2 #10, 1 #8	19 / .0281" BC 19 / .0223" BC 19 / .0177" BC	black or lime green	0.648"

Powering ABS As of March 1998, all trucks and trailers were required by government law to be equipped with an Anti-lock Braking System (ABS). Through the Maintenance Council, the trucking industry developed recommended voltage requirements for ABS, which includes an 8 gauge ground, 10 gauge stop light and auxiliary wire. The lime green cable above meets these specifications which ensures constant power to your anti-lock braking system. While not mandated, the green jacket allows for easy identification. ABS cable that meets the mandated requirements is also offered in black.

All spool weights (lbs per spool) are approximate.



Scan for pricing or go to www.delcity.net/catalogpricing

Cross-Link Wire - TXL Wire

TXL wire is a stranded, bare copper, thin wall, special purpose automotive wire that is insulated with chemically cross-lined polyethylene. The insulation has a smooth surface and is available in bright colors. It operates optimally between the extreme temperatures of -40° C to 125° C (-40°F to 257° F) without melting, fusing or cracking. It is resistant to moisture and most solvents. Meets or exceeds SAE specification J-1128, Ford ESB-M1L123A and Chrysler MS-8288. Rated to 60V DC 25V, AC. **Please specify color with a 2-digit suffix; see special note box below.**



3 1/2" plastic spool



6 1/2 & 10 1/2" plastic spool

Special Note

Please specify a color by applying a 2-digit suffix to the part number (corresponding to your color preference):

- 01 – red 05 – black
- 02 – white
- 03 – blue
- 04 – green

Example: when ordering a 100-ft spool of 18-Ga Crosslink wire, **38181**, in blue please order **3818103**.



18 gauge			
part no.	length/reel	lbs per spool	spool diameter
38181	100'	1	3 1/2"
38185	500'	5	6 1/2"
38187	1000'	9	10 1/2"
38188	5000'	45	15 1/2"

12 gauge			
part no.	length/reel	lbs per spool	spool diameter
38121	100'	1	3 1/2"
38125	500'	5	6 1/2"
38127	1000'	9	10 1/2"
38128	5000'	45	15 1/2"

16 gauge			
part no.	length/reel	lbs per spool	spool diameter
38161	100'	1	3 1/2"
38165	500'	5	6 1/2"
38160	1000'	9	10 1/2"
38167	5000'	45	15 1/2"

specification guide			
SAE size	conductor stranding	wall mils*	nominal O.D.
18 ga	16/30	0.026"	0.092"
16 ga	19/29	0.031"	0.103"
14 ga	19/27	0.023"	0.142"
12 ga	19/25	0.023"	0.177"

* wall mils = insulation thickness

14 gauge			
part no.	length/reel	lbs per spool	spool diameter
38141	100'	1	3 1/2"
38145	500'	5	6 1/2"
38140	1000'	9	10 1/2"
38148	5000'	45	15 1/2"

2-1 Multi-Wire Crimp & Shrink Tube Terminal Kit – Grab-N-Go Jars

A starter kit that contains multiple and same sized 2-1 multi-wire shrink tube butt connectors for professional waterproof connections. It features the most popular size connectors (covering 12-10, 16-14 and 20-18 gauge). The jar has a flip top opening for easy pour and is approximately 2.625" X 2.625" X 4.375".

For a complete listing of kit contents, see page 294.



part no.	description	pieces
895	2-1 multi-wire crimp and shrink tube connector Grab-N-Go assortment jar	25
8951	2-1 multi-wire 20-18 gauge solder and shrink tube connector Grab-N-Go jar	35
8952	2-1 multi-wire 16-14 gauge solder and shrink tube connector Grab-N-Go jar	25
8953	2-1 multi-wire 12-10 gauge solder and shrink tube connector Grab-N-Go jar	15



Scan for pricing or go to www.delcity.net/catalogpricing



3 1/2" plastic spool



6 1/2 & 10 1/2" plastic spool

Special Note

Please specify a color by applying a 2-digit suffix to the part number (corresponding to your color preference):

- 01 – red 05 – black
- 02 – white 06 – yellow
- 03 – blue 07 – brown
- 04 – green

Example: when ordering a 100-ft spool of 18-Ga

Crosslink wire, **41181**, in blue please order **4118103**.

Cross-Link Wire – GXL Wire

GXL wire is a stranded, bare copper, medium wall thickness, automotive wire that is manufactured with a chemically cross-linked, polyethylene insulation. This wire is identical in characteristics to SXL wire except for the thinner insulation. GXL wire resists fusing or melting at high temperatures and is resistant to moisture and solvents, making it ideal for engine compartments. Wire meets or exceeds SAE J1128, Ford ESB-M1L85A and Chrysler MS-8900 specifications. Temperature rating: -40°C to 125°C (-40°F to 257°F). Rated to 60V DC, 25V AC. **Please specify color with a 2-digit suffix; see special note box below.**



18 gauge

part no.	length/reel	lbs per spool	spool diameter
41181	100'	1	3 1/2"
41185	500'	5	6 1/2"
41180	1000'	9	10 1/2"
41188	5000'	45	15 1/2"

12 gauge

part no.	length/reel	lbs per spool	spool diameter
41121	100'	3	3 1/2"
41125	500'	14	10 1/2"
41120	1000'	26	10 1/2"
41128	3000'	81	15 1/2"

16 gauge

part no.	length/reel	lbs per spool	spool diameter
41161	100'	2	3 1/2"
41165	500'	6	6 1/2"
41160	1000'	13	10 1/2"
41168	5000'	65	15 1/2"

10 gauge*

part no.	length/reel	lbs per spool	spool diameter
41101	100'	5	6 1/2"
41105	500'	22	10 1/2"
41100	750'	28	10 1/2"
41108	2500'	98	15 1/2"

* Only available in red, white & black.

14 gauge

part no.	length/reel	lbs per spool	spool diameter
41141	100'	2	3 1/2"
41145	500'	9	6 1/2"
41140	1000'	18	10 1/2"
41148	5000'	90	15 1/2"

specification guide

SAE size	conductor stranding	wall mils*	nominal O.D.
18 ga	16/30	0.023"	0.092"
16 ga	19/29	0.023"	0.103"
14 ga	19/27	0.023"	0.117"
12 ga	19/25	0.026"	0.142"
10 ga	19/23	0.031"	0.179"

* wall mils = insulation thickness



9000

7-contact Round Pin Coiled Trailer Cable

These coiled cables are designed to withstand the toughest environments for the heavy-duty tractor/trailer industry. The patented Xenoy® plugs are virtually destruction and corrosion proof. They are also lightweight and have a locking grit that will not disengage from a pull force of up to 480 lbs. The wire jacket resists chemicals, cutting, abrasion, gasoline, ozone, water, solvents, sunlight and is designed with a sag-proof memory coil. Temperature rating: -56°C to 204°C (-70°F to 400°F).

part no.	description	gauge/conductor
9000	green ABS coiled cable, 12'	4-12 ga, 2-10 ga, 1-8 ga
9005	green ABS coiled cable, 15'	4-12 ga, 2-10 ga, 1-8 ga
9010	black jacket coiled cable, 12'	6-12 ga, 1-10 ga,
9015	black jacket coiled cable, 15'	6-12 ga, 1-10 ga,

All spool weights (lbs per spool) are approximate.



Scan for pricing or go to www.delcity.net/catalogpricing



3 1/2" plastic spool



6 1/2" x 10 1/2" plastic spool

Cross-link-SXL Wire

SXL wire is a stranded, bare copper, thick wall thickness, automotive wire that is manufactured with a chemically cross-linked, polyethylene insulation. The wire has a smooth surface and is offered in bright colors. SXL wire resists fusing or melting at high temperatures and is resistant to moisture and solvents, making it ideal for engine compartments. Wire meets or exceeds SAE J1128, Ford ESB-M1L123A and Chrysler MS-5919 specifications. Temperature rating: -40°C to 125°C (-40°F to 257°F). Rated to 60V DC 25V AC.

Please specify color with a 2-digit suffix; see special note box below.



18 gauge

part no.	reel size	lbs per spool	spool diameter
37181	100'	2	3 1/2"
37185	500'	5	6 1/2"
37180	1000'	11	10 1/2"
37187	2500'	26	10 1/2"
37188	5000'	52	15 1/2"

12 gauge*

part no.	reel size	lbs per spool	spool diameter
37121	100'	3	3 1/2"
37125	500'	15	10 1/2"
37127	1000'	29	10 1/2"
37128	2000'	62	15 1/2"

* Not available in brown

16 gauge

part no.	reel size	lbs per spool	spool diameter
37161	100'	2	3 1/2"
37165	500'	7	6 1/2"
37160	1000'	14	10 1/2"
37167	2000'	28	10 1/2"
37168	4000'	54	15 1/2"

10 gauge*

part no.	reel size	lbs per spool	spool diameter
37101	100'	5	6 1/2"
37105	500'	22	10 1/2"
37107	750'	32	10 1/2"
37108	1500'	64	15 1/2"

* Only available in: red, white & black

14 gauge

part no.	reel size	lbs per spool	spool diameter
37141	100'	3	3 1/2"
37145	500'	10	6 1/2"
37140	1000'	20	10 1/2"
37147	1500'	30	10 1/2"
37148	3000'	60	15 1/2"

specification guide

SAE size	conductor / stranding	wall mils*	nominal O.D.
18 ga	16/30	0.030"	.102"
16 ga	19/29	0.032"	.118"
14 ga	19/27	0.035"	.137"
12 ga	19/25	0.037"	.160"
10 ga	19/23	0.041"	.191"

* wall mils = insulation thickness

Special Note

Please specify a color by applying a 2-digit suffix to the part number (corresponding to your color preference):

- 01 – red 05 – black
- 02 – white 06 – yellow
- 03 – blue 07 – brown
- 04 – green

Example: when ordering a 100-ft spool of 18-Ga Cross-link wire, **37181**, in blue please order **3718103**.

Wire Markers

Each cassette contains 96 one-inch perforated markers numbered 0-9. Laminated mylar markers resist dirt, grease, oil, moisture, solvents and chemicals. Designed to easily hook to supply box or tool pouch for fast access. Working temperature: -40°C to 260°C (-40°F to 500°F).



part no.	description	legend
995000	wire markers	0-9

Pocket Pack Wire Marker

Wire markers can save time and money when you are on-site with troubleshooting, maintenance and repair. The nylon impregnated cloth resists moisture, dirt and oil. The non-smear legends assure high visibility for instant, positive identification.



part no.	description	legend
19015219	pocket pack wire marker	0-9

All spool weights (lbs per spool) are approximate.



Scan for pricing or go to www.delcity.net/catalogpricing



6 1/2" plastic spool



6 1/2" x 10 1/2" plastic spool

RVI Hook-up Wire

RVI wire is a stranded, bare copper, thermoplastic insulated wire that is moisture resistant and provides added protection against nicks and abrasions. This wire is ideal for wiring of recreational vehicles, automotive, truck, trailer and marine applications. RVI wire can also be used to wire machine tools, appliances and control cabinets. RVI wire meets or exceeds Machine Tool Wire (MTW) requirements. Temperature rating of 105°C (221°F) dry or where exposed to moisture or oil in temperatures not exceeding 60°C (140°F). Rated to 600V. **Please specify color with a 2-digit suffix; see special note box below.**



18 gauge

part no.	length/ reel	lbs per spool	spool diameter
29181	100'	2	3 1/2"
29185	500'	6	6 1/2"
29180	1000'	11	6 1/2"
29188	5000'	56	15 1/2"

10 gauge*

part no.	length/ reel	lbs per spool	spool diameter
29101	100'	5	6 1/2"
29105	500'	22	10 1/2"
29107	1000'	44	10 1/2"
29108	2000'	92	15 1/2"

* Only available in: red, white & black.

16 gauge

part no.	length/ reel	lbs per spool	spool diameter
29161	100'	2	3 1/2"
29165	500'	8	6 1/2"
29160	1000'	16	6 1/2"
29167	2000'	29	10 1/2"
29168	4000'	61	15 1/2"

8 gauge*

part no.	length/ reel	lbs per spool	spool diameter
29081	100'	8	6 1/2"
29087	500'	37	10 1/2"
29088	2000'	148	17 1/2"

* Only available in: red, white & black.

14 gauge

part no.	length/ reel	lbs per spool	spool diameter
29141	100'	3	3 1/2"
29145	500'	10	6 1/2"
29140	1000'	20	10 1/2"
29147	1500'	31	10 1/2"
29148	3500'	77	15 1/2"

specification guide

AWG size	conductor / stranding	wall mils*	nominal O.D.
18 ga	16/0.0104	0.030"	.111"
16 ga	26/0.0104	0.030"	.123"
14 ga	41/0.0104	0.030"	.136"
12 ga	65/0.0104	0.030"	.156"
10 ga	104/0.0104	0.030"	.181"
8 ga	168/0.010	0.045"	.249"

* wall mils = insulation thickness

Special Note

Please specify a color by applying a 2-digit suffix to the part number (corresponding to your color preference):

- 01 – red 05 – black
- 02 – white 06 – yellow
- 03 – blue 07 – brown
- 04 – green

Example: when ordering a 100-ft spool of 18-Ga RVI wire, **29181**, in blue please order **2918103**.

12 gauge

part no.	length/ reel	lbs per spool	spool diameter
29121	100'	3	3 1/2"
29125	500'	15	10 1/2"
29127	1000'	29	10 1/2"
29128	3000'	87	17 1/2"

All spool weights (lbs per spool) are approximate.



6½" x 10½" plastic spool

Tinned Copper Wire – Marine Grade

Tinned copper wire is manufactured to meet or exceed UL1426, US Coast Guard Charterboat (CRF Title 46), ABYC and CSA TEW standards. The tin electroplated copper wire provides the ultimate protection against corrosion. Ideal use includes general wiring under the dash, lights, radar, radio and a variety of marine related wiring. The flexible jacketing is resistant to moisture, battery acid, oil, gas, UV radiation and is flame retardant. AWG wire contains 6.5% more copper than standard SAE wire. Temperature rating: 105°C (221°F), 75°C (167°F) wet (BC-5W2). Rated to 600V.

Please specify color with a 2-digit suffix; see special note box below.



Scan for pricing or go to www.delcity.net/catalogpricing



18 gauge

part no.	length/ reel	lbs per spool	spool diameter
47181	100'	2	3½"
47185	500'	6	6½"

6 gauge*

part no.	length/ reel	lbs per spool	spool diameter
47062	25'	4	3½"
47061	100'	13	10½"
47065	500'	63	11½"

* Only available in: red & black.

16 gauge

part no.	length/ reel	lbs per spool	spool diameter
47161	100'	2	3½"
47165	500'	8	6½"

4 gauge*

part no.	length/ reel	lbs per spool	spool diameter
47042	25'	5	3½"
47041	100'	19	10½"
47045	500'	91	11½"

* Only available in: red & black.

14 gauge

part no.	length/ reel	lbs per spool	spool diameter
47141	100'	3	3½"
47145	500'	10	6½"
47140	1000'	20	10½"

2 gauge*

part no.	length/ reel	lbs per spool	spool diameter
47022	25'	7	6½"
47021	100'	28	10½"
47025	400'	112	10½"

* Only available in: red & black.

12 gauge

part no.	length/ reel	lbs per spool	spool diameter
47121	100'	3	3½"
47125	400'	12	10½"
47120	1000'	30	10½"

specification guide

AWG size	conductor / stranding	nominal O.D.
18 ga	16/30	.109"
16 ga	26/30	.125"
14 ga	41/30	.141"
12 ga	65/30	.156"
10 ga	105/30	.219"
8 ga	168/30	.313"
6 ga	266/30	.344"
4 ga	420/30	.406"
2 ga	655/30	.469"

10 gauge*

part no.	length/ reel	lbs per spool	spool diameter
47101	100'	5	6½"
47105	500'	22	10½"
47100	1000'	43	10½"

* Only available in: red & black.

8 gauge*

part no.	length/ reel	lbs per spool	spool diameter
47081	100'	8	6½"
47085	500'	35	10½"
47080	1000'	70	10½"

* Only available in: red & black.

Special Note

Please specify a color by applying a 2-digit suffix to the part number (corresponding to your color preference):

01 – red 05 – black
04 – green

Example: when ordering a 100-ft spool of 18-Ga Tinned wire, 47181, in red please order **4718101**.



All spool weights (lbs per spool) are approximate.



Scan for pricing or go to www.delcity.net/catalogpricing



6 1/2" x 10 1/2" plastic spool



11 1/2" and 15 1/2" wooden reel

Tinned Copper Cable – Marine Grade

Tinned cable is manufactured to meet UL1426 standards. The tin electroplated copper wire provides the ultimate protection against corrosion. Outer jacketing helps protect against moisture, vibration, chemicals, acids and abrasion. Ideal for marine lights, refrigerators, electronics and heaters. Internal wire is color-coded to industry standards. Temperature rating: 105°C (221°F), 75°C (167°F) wet (BC-5W2). Rated to 600V.

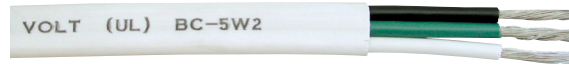

16 gauge / 3 conductor triplex

part no.	length/reel	lbs per spool	spool diameter
48361	100'	7	6 1/2"
48363	250'	17	10 1/2"
48367	500'	34	11 1/2"
48368	1000'	67	15 1/2"

14 gauge / 3 conductor triplex

part no.	length/reel	lbs per spool	spool diameter
48341	100'	10	10 1/2"
48343	250'	23	10 1/2"
48347	500'	45	11 1/2"
48348	1000'	90	15 1/2"

14 gauge / 2 conductor duplex

part no.	length/reel	lbs per spool	spool diameter
48241	100'	6	6 1/2"
48243	250'	16	10 1/2"
48247	500'	31	10 1/2"
48248	1000'	64	15 1/2"

12 gauge / 3 conductor triplex

part no.	length/reel	lbs per spool	spool diameter
48321	100'	12	10 1/2"
48323	250'	30	10 1/2"
48327	500'	60	11 1/2"
48328	1000'	121	15 1/2"

10 gauge / 3 conductor triplex

part no.	length/reel	lbs per spool	spool diameter
48301	100'	18	10 1/2"
48303	250'	45	10 1/2"
48307	500'	86	11 1/2"
48308	1000'	172	15 1/2"

specification guide 3 conductor stranding

AWG size	conductor stranding	wall, mils* cond./JKT.	nominal dimension
16/3	26/0.010	30/0.030"	0.187" x 0.433"
14/3	41/0.010	30/0.030"	0.220" x 0.487"
12/3	65/0.010	30/0.030"	0.230" x 0.528"
10/3	104/0.010	30/0.030"	0.270" x 0.620"

specification guide 2 conductor stranding

AWG size	conductor stranding	wall, mils* cond./jkt.	nominal dimension
14/2	41/0.010	30/0.030"	0.215" x 0.350"

* wall mils = insulation thickness

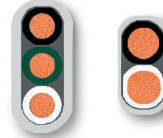

Color Code:
with white outer jacket

black black
green white
white

All spool weights (lbs per spool) are approximate.



10 1/2" plastic spool

Battery Cable – Type SGT

Battery cable is manufactured to SAE J-1127 specification. The Starter or Ground General Purpose Thermoplastic (SGT) cable has smooth thermoplastic polyvinyl chloride jacket to provide protection against cracking, abrasion, weather, oil and acids. Ideal use is to provide connection from battery to power or ground. Temperature rating: -40°C to 105°C (194°F to 221°F). Rated to 60V DC.

Please specify color with a 2-digit suffix; see special note box below.



Scan for pricing or go to www.delcity.net/catalogpricing

Use With
battery terminals & lugs
PAGES 269-276



25' coil size

part no.	gauge	lbs per coil
52162	6	3
52142	4	4
52122	2	6
52112	1	8
52102	1/0	10
52002	2/0	12
52302	3/0	15
52402	4/0	20

100' spool size

part no.	gauge	lbs per spool	spool diameter
55161	6	12	10 1/2"
55141	4	17	10 1/2"
55121	2	27	10 1/2"
55111	1	30	10 1/2"
55101	1/0	39	10 1/2"
55001	2/0	49	10 1/2"
55301	3/0	62	10 1/2"
55401	4/0	82	11 1/2"

500' spool size

part no.	gauge	lbs per spool	spool diameter
55168	6	58	11 1/2"
55148	4	83	15 1/2"
55128	2	127	17 1/2"
55118	1	150	17 1/2"
55108	1/0	198	24"
55008	2/0	236	19 1/2"
55308	3/0	316	23 1/2"
55408	4/0	421	23 1/2"

specification guide

gauge	stranding	nominal O.D.
6	133/0.0137	0.310"
4	133/0.0171	0.375"
2	133/0.0218	0.438"
1	133/0.0243	0.480"
1/0	133/0.0275	0.525"
2/0	133/0.0309	0.575"
3/0	361/0.0210	0.661"
4/0	361/0.0239	0.726"

Special Note

Please specify a color by applying a 2-digit suffix to the part number (corresponding to your color preference):

01 – red **05** – black

Example: when ordering a 25-ft spool of 6-Ga Battery Cable, **52162**, in red please order **5216201**.

INFORMATION

We recommend using dual wall adhesive shrink tubing for protection against corrosion. See page 41-45 for desired size and style. To choose proper size, follow these steps:

1. Choose heat shrink ratio and grade that is desired.
2. Identify desired gauge of battery cable and corresponding nominal OD from specification chart.
3. Choose the appropriate "inside diameter as supplied" heat shrink based on "inside diameter after recovery".
4. Be sure that "inside diameter after recovery" is slightly smaller than outside diameter of battery cable.

suggested ampacity for battery cable

gauge	10-ft	20-ft	30-ft	40-ft	50-ft	60-ft	80-ft	100-ft
6	200	100	50	50	50	36	36–24	24–20
4		200–150	100	100	50	50	50	36
2			200–150	150	100	100	50	50
1				200	150	100	100	50
1/0					200	150	100	100
2/0						200	150	100
3/0							200	150
4/0								200

All spool weights (lbs per spool) are approximate.



Scan for pricing or go to www.delcity.net/catalogpricing



10½" plastic spool

Welding Cable — Class K

Welding cable is manufactured to meet the National Electrical Code article 63 electric welders. The highly flexible EPDM jacket encompasses the fully annealed rope stranded bare copper. The high degree of flexibility makes this cable ideal for cold weather installations and where confined or tight areas require single or multiple bends. Welding cable is resistant to cuts, tears, abrasion, grease, oil, water and flame. Temperature rating: -50° C to 105° C (-58° F to 221° F). Rated to 600V AC.

Please specify color with a 2-digit suffix; see special note box below.



Special Note

Please specify a color by applying a 2-digit suffix to the part number (corresponding to your color preference):

01 – red 05 – black

Example: when ordering a 25-ft spool of 6-Ga welding cable, **57162**, in red please order **5716201**.

25' coil size

part no.	gauge	lbs per coil
57162	6	3
57142	4	4
57122	2	6
57112	1	8
57102	1/0	11
57002	2/0	12
57302	3/0	16
57402	4/0	19

100' spool size

part no.	gauge	lbs per spool	spool diameter
57161	6	13	10½"
57141	4	18	10½"
57121	2	26	10½"
57111	1	39	10½"
57101	1/0	47	10½"
57001	2/0	56	10½"
57301	3/0	68	10½"
57401	4/0	85	10½"

500' spool size

part no.	gauge	lbs per spool	spool diameter
57168	6	56	12½"
57148	4	77	12½"
57128	2	122	14¾"
57118	1	159	17¾"
57108	1/0	196	17¾"
57008	2/0	241	24"
57308	3/0	300	24"
57408	4/0	378	24"

specification guide

gauge	stranding	nominal O.D.
6	7/37/0.010	.320"
4	7/52/0.010	.348"
2	12/52/0.010	.420"
1	12/65/0.010	.503"
1/0	19/52/0.010	.533"
2/0	19/65/0.010	.586"
3/0	19/81/0.010	.625"
4/0	19/106/0.010	.720"

suggested ampacity for welding cable

gauge	50-ft	75-ft	100-ft	125-ft	150-ft	175-ft	200-ft	225-ft	250-ft	300-ft	350-ft
4	100	100									
2	200	150	100	100							
1	250/300	200	150		100						
1/0	350	250	200	150		100	100				
2/0	400/450	300	250	200	150			100	100		
3/0	500	350/400	300	250	200	150	150			100	
4/0	550/600	450/500	350/400	300	250	200	200	150	150		100

All spool weights (lbs per spool) are approximate.



Type SJOOW Power Cord  

This power cord is UL recognized and CSA listed. EDPM insulation is resistant to oil, acid, impact, abrasion, sunlight, flame and high temperature. Operates optimally between temperatures of -40°C to 90°C (-40°F to 194°F). Designed for use with portable tools, small motors and power extensions. Passes CSAFT2 flame test. Rated to 300V.



Scan for pricing or go to www.delcity.net/catalogpricing



INFORMATION

COLOR CODE

- 2 Conductor
black, white
- 3 Conductor
black, white, green
- 4 Conductor
black, white, green, red

part no.	gauge/ conductors	standard spool size	lbs per spool	nominal O.D.
2183	18-2	250'	13	0.285"
3183	18-3	250'	16	0.310"
4183	18-4	250'	19	0.330"
2163	16-2	250'	16	0.310"
3163	16-3	250'	18	0.330"
4163	16-4	250'	24	0.357"
2143	14-2	250'	19	0.340"
3143	14-3	250'	26	0.365"
4143	14-4	250'	30	0.395"



Type SOOW Power Cord  

This power cord is UL recognized and CSA listed. The EDPM insulation is resistant to oil, acid, impact, abrasion, sunlight, flame and high temperature. Operates optimally between the temperatures of -40°C to 90°C (-40°F to 194°F), while maintaining flexibility. Designed for use with industrial equipment, heavy tools, battery chargers, portable lights and power extensions. Passes CSAFT2 flame test. Rated to 600V.



INFORMATION

COLOR CODE

- 2 Conductor
black, white
- 3 Conductor
gray, white, green
- 4 Conductor
black, white, green, red

part no.	gauge/ conductors	standard spool size	lbs per spool	nominal O.D.
2165	16-2	250'	21	0.370"
3165DL	16-3	250'	25	0.390"
4165	16-4	250'	31	0.415"
2145DL	14-2	250'	37	0.500"
3145	14-3	250'	43	0.525"
4145	14-4	250'	52	0.570"
2125	12-2	250'	47	0.570"
3125DL	12-3	250'	62	0.595"
4125	12-4	250'	71	0.645"

All spool weights (lbs per spool) are approximate.



Scan for pricing or go to www.delcity.net/catalogpricing



75550



75552



75553



75560



75558



75556



75554

15A U-blade Cap & Connector Body

The male and female ends feature parallel blades and a "U" ground blade with an adjustable cord grip. Both feature standard parallel blade configurations. The allowable cord hole size is .281" to .625". Rating: 15A @ 125V AC.



75552



75550

part no.	description
75550	male 3 wire cap
75552	female 3 wire body

15A Right Angle Plug

This right angle plug allows you to plug in closer to walls without bending or damaging power cords. Cords can be terminated in 8 different positions (in 45° intervals) so you can direct cords in the most convenient direction. This plug is compact, yet can handle a broad range of cord sizes, accommodating .30" to .65" cords. Rating: 15A @ 125V AC, 2-pole, 3-wire.



75553

part no.	description
75553	15 amp 3-wire U-blade right angle male plug

30A Locking Plug & Receptacle

Modify or create your own power cord connection. Terminals are clamp-type, with color-coded brass terminal screws, #10-32. All blades are solid brass .07" thick. NEMA Configuration L15-30P. Devices are clearly marked with amperage, voltage, rating and NEMA. Rating: 30A @ 250V AC, 3-phase, 3-pole, 4-wire.



75558



75560

part no.	description
75558	30 amp NEMA locking receptacle
75560	30 amp NEMA locking plug

20A Locking Plug & Receptacle

Modify or create your own power cord connection. Terminals are clamp-type, with color-coded brass terminal screws, #10-32. All blades are solid brass .06" thick. NEMA Configuration L5-20P. Rating: 20A @ 125V AC, single-phase, 2-pole, 3-wire.



75554



75556

part no.	description
75554	20 amp NEMA locking receptacle
75556	20 amp NEMA locking plug

GFCI Receptacle Tester & Circuit Analyzer

Tests ground fault breakers by overloading circuit and tripping GFCI. Tests for seven conditions: ground fault interruption, open ground, open neutral, open hot, hot/ground reverse, hot/neutral reverse and correct wiring. The succession of yellow and red lights provide indication of circuit status or specifies which wire is defective. Tester trips GFCI between 6-9mA.



INFORMATION

HOW IT WORKS

Simply plug tester into any circuit protected by ground fault receptacle (110-125 volts AC) and press black button to overload circuit.

part no.	description
990980	GFCI receptacle tester & circuit analyzer



Scan for pricing or go to www.delcity.net/catalogpricing

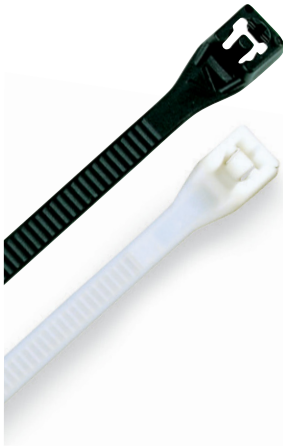

Standard Self-locking Cable Ties

These nylon 6/6 cable ties provide up to 50% more tensile strength and 15% larger bundle diameters than competitive products. Their positive-locking teeth, closely and evenly spaced on both sides of the body, provide increased strength and fine adjustment for any bundling need. The raised ridges on the cable ties' bent tips are designed to provide a secure grip while requiring minimal effort to close. The patented, one-piece, injection-molded construction eliminates failure due to parts working loose or breaking off. Smooth, rounded edges make the ties easy to handle and install without cutting hands. Self-locking cable ties are recognized under the Component Program of Underwriters Laboratories Inc and meet UL94V-2 Flammability Classification. Operating temperature: -40°C to 85°C (-40°F to 185°F).



Bent tip provides easy insertion

Closely spaced serrations permit fine adjustment

Tapered neck increases strength



INFORMATION

Melting Point:
265°C (509°F)

Brittleness temperature:
-112°C (-169°F)
at 2% water

natural nylon

part no.	approx. length	approx. width	loop tensile strength	max. dia.	pkg. qty.
972203	4"	.100"	18 lbs	1 ³ / ₁₆ "	100
9722	4"	.100"	18 lbs	1 ³ / ₁₆ "	1000
972603	6"	.140"	45 lbs	1 ³ / ₈ "	100
9726	6"	.140"	45 lbs	1 ³ / ₈ "	1000
972803	8"	.170"	75 lbs	2"	100
9728	8"	.170"	75 lbs	2"	1000
973003	11"	.170"	75 lbs	3"	100
9730	11"	.170"	75 lbs	3"	1000
973203	14"	.170"	75 lbs	4"	100
9732	14"	.170"	75 lbs	4"	1000

UV-resistant black nylon

part no.	approx. length	approx. width	loop tensile strength	max. dia.	pkg. qty.
962303	4"	.100"	18 lbs	1 ³ / ₁₆ "	100
9623	4"	.100"	18 lbs	1 ³ / ₁₆ "	1000
962703	6"	.140"	45 lbs	1 ³ / ₈ "	100
9627	6"	.140"	45 lbs	1 ³ / ₈ "	1000
962903	8"	.170"	75 lbs	2"	100
9629	8"	.170"	75 lbs	2"	1000
963103	11"	.170"	75 lbs	3"	100
9631	11"	.170"	75 lbs	3"	1000
963303	14"	.170"	75 lbs	4"	100
9633	14"	.170"	75 lbs	4"	1000



Heavy-duty Cable Ties

The one-piece construction of these heavy-duty ties offer added strength and durability. They are manufactured from nylon 6/6 material and meet UL94-V2 Flammability Classification. Operating temperature: -40°C to 85°C (-40°F to 185°F).

natural nylon

part no.	approx. length	approx. width	loop tensile strength	max. dia.	pkg. qty.
9734	8"	.350"	120 lbs	2"	100
9736	14½"	.350"	120 lbs	4"	100
9738	18"	.350"	143 lbs	5"	100
9740	21"	.350"	143 lbs	6"	100
9742	30"	.350"	175 lbs	9"	50
9744	36"	.350"	175 lbs	11"	50
9748	48"	.350"	175 lbs	15"	50

UV-resistant black nylon

part no.	approx. length	approx. width	loop tensile strength	max. dia.	pkg. qty.
9635	8"	.350"	120 lbs	2"	100
9637	14½"	.350"	120 lbs	4"	100
9639	18"	.350"	143 lbs	5"	100
9641	21"	.350"	143 lbs	6"	100
9643	30"	.350"	175 lbs	9"	50
9645	36"	.350"	175 lbs	11"	50
9649	48"	.350"	175 lbs	15"	50

Use With
adhesive bases
PAGE 30



cable ties & wire fasteners

Standard Colored Cable Ties

Use colored ties for wire bundle identification. These self-locking cable ties are recognized under the Component Program of Underwriters Laboratories Inc and meet UL94V-2 Flammability Classification. Operating temperature: -40°C to 85°C (-40°F to 185°F).



Scan for pricing or go to www.delcity.net/catalogpricing

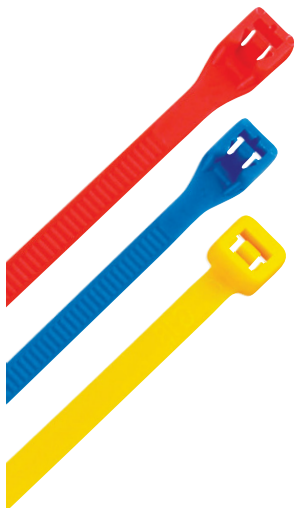

red

part no.	approx. length	approx. width	loop tensile strength	max. dia.	pkg. qty.
9341	6"	.140"	30 lbs	1 ³ / ₈ "	100
9342	8"	.170"	75 lbs	2"	100
9343	11"	.170"	75 lbs	3"	100
9344	14"	.170"	75 lbs	4"	100



yellow

part no.	approx. length	approx. width	loop tensile strength	max. dia.	pkg. qty.
9356	6"	.140"	30 lbs	1 ³ / ₈ "	100
9357	8"	.170"	75 lbs	2"	100
9358	11"	.170"	75 lbs	3"	100
9359	14"	.170"	75 lbs	4"	100



green

part no.	approx. length	approx. width	loop tensile strength	max. dia.	pkg. qty.
9351	6"	.140"	30 lbs	1 ³ / ₈ "	100
9352	8"	.170"	75 lbs	2"	100
9353	11"	.170"	75 lbs	3"	100
9354	14"	.170"	75 lbs	4"	100



blue

part no.	approx. length	approx. width	loop tensile strength	max. dia.	pkg. qty.
9346	6"	.140"	30 lbs	1 ³ / ₈ "	100
9347	8"	.170"	75 lbs	2"	100
9348	11"	.170"	75 lbs	3"	100
9349	14"	.170"	75 lbs	4"	100



purple

part no.	approx. length	approx. width	loop tensile strength	max. dia.	pkg. qty.
9371	6"	.140"	30 lbs	1 ³ / ₈ "	100
9372	8"	.170"	75 lbs	2"	100
9373	11"	.170"	75 lbs	3"	100
9374	14"	.170"	75 lbs	4"	100



orange

part no.	approx. length	approx. width	loop tensile strength	max. dia.	pkg. qty.
9366	6"	.140"	30 lbs	1 ³ / ₈ "	100
9367	8"	.170"	75 lbs	2"	100
9368	11"	.170"	75 lbs	3"	100
9369	14"	.170"	75 lbs	4"	100



990080



990085



990090

Cable Tie Tools

These tools are extremely reliable and easy to use. The tension control on 990080 and 990085 allow adjustments for a range of lightweight ties up to 75 lbs tension setting. The 990080 tightens and cuts the cable tie flush. The 990090 is a tool for heavy-duty cable ties with 120 lbs to 175 lbs tension settings.

part no.	description
990080	economical cable tie tool
990085	standard cable tie tool
990090	heavy-duty cable tie tool

Precision Lock Cable Ties

These cable ties with metal pawl are designed to accurately adjust to precise locking points on the body of the tie. Their smooth, notchless outside reduces stress under tension and provides a lower profile body than notched ties. Manufactured from nylon 6/6, they are ideal for use in HVAC and Datacom installations.



natural nylon

part no.	approx. length	approx. width	loop tensile strength	max. dia.	pkg. qty.
9980	7"	.190"	50 lbs	2"	20
9982	11"	.190"	50 lbs	3"	10

UV-resistant black nylon

part no.	approx. length	approx. width	loop tensile strength	max. dia.	pkg. qty.
9986	7"	.190"	50 lbs	2"	20
9988	11"	.190"	50 lbs	3"	10



Scan for pricing or go to www.delcity.net/catalogpricing

Beadle™ Wrap Releasable Cable Ties

Beadle™ Wrap releasable cable ties are reusable ties that are easier to use than a twist tie, more versatile than a cable tie and stronger than hook and loop fasteners. Two keyhole slots provide a double lock for a secure wrap. Engineered from resin, compliant with FDA 21 CFR 177-1500 and conforms to MIL-M-20693B.



UV resistant black

part no.	approx. length	loop tensile strength	min. dia.	max. dia.	pkg. qty.
19015202	8"	70	1/4"	2"	15
19015203	8"	70	1/4"	2"	40
19015206	12"	70	1/4"	3-1/4"	15
19015207	12"	70	1/4"	3-1/4"	40
19015210	18"	140	1/2"	5"	10
19015211	18"	140	1/2"	5"	25
19015213	24"	140	1"	7"	5
19015214	24"	140	1"	7"	20

green

part no.	approx. length	loop tensile strength	min. dia.	max. dia.	pkg. qty.
19015200	8"	70	1/4"	2"	15
19015204	12"	70	1/4"	3-1/4"	15
19015208	18"	140	1/2"	5"	10

yellow

part no.	approx. length	loop tensile strength	min. dia.	max. dia.	pkg. qty.
19015201	8"	70	1/4"	2"	15
19015205	12"	70	1/4"	3-1/4"	15
19015209	18"	140	1/2"	5"	10
19015212	24"	140	1"	7"	5

Releasable Cable Ties

The release feature of these ties enable the cable tie to be re-used. These one-piece designed ties are UV-resistant, black nylon 6/6. Recognized under the Component Program of Underwriters Laboratories Inc. for use at temperatures not exceeding 85°C (185°F). Meets UL94V-2 Flammability Classification.

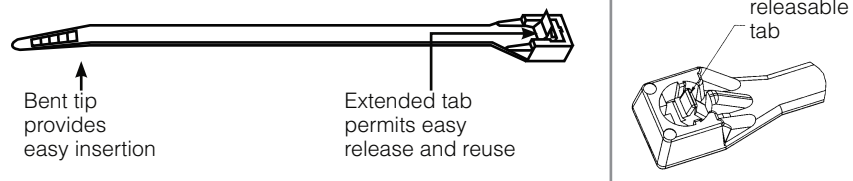

UV-resistant black nylon

part no.	approx. length	approx. width	loop tensile strength	max. dia.	pkg. qty.
9954	7½"	.177"	50 lbs	1¾"	100
9956	11"	.177"	50 lbs	3"	100

INFORMATION

To release, grasp the head of the cable tie, deflect release tab and pull the cable tie away from bundle.

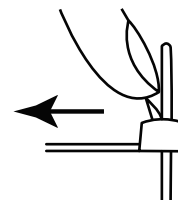

cable ties & wire fasteners



Scan for pricing or go to www.delcity.net/catalogpricing



Push-mount Ties

Push-mount cable ties snap quickly into a 1/4" hole to attach a bundle to another surface. The mount portion is easily passed into a pre-drilled hole and locks into place. All ties are manufactured from durable nylon 6/6. Recognized under the Component Program of Underwriters Laboratories Inc. for use at temperatures not exceeding 85°C (185°F). Meets UL94V-2 Flammability Classification.

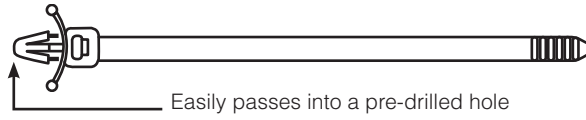

natural nylon

part no.	approx. length	approx. width	loop tensile strength	max. dia.	pkg. qty.
9852	7"	.197"	40 lbs	1 3/8"	100

UV-resistant black nylon

part no.	approx. length	approx. width	loop tensile strength	max. dia.	pkg. qty.
9671	7"	.197"	40 lbs	1 3/8"	100



Specialty Cable Ties

These ties are ideal for attaching instructions or I.D. plates. The head can be locked between any two beads to allow for multiple lengths. Manufactured from durable nylon 6/6 to an approximate .04" thickness, for use at temperatures not exceeding 85°C (185°F).

bar-lok ladder

part no.	approx. length	approx. width	loop tensile strength	maximum bundle diameter	pkg. qty.
9924	7"	.14"	40 lbs	1 3/4"	100
9926	11"	.14"	40 lbs	3"	100

beaded non-releasable

part no.	approx. length	loop tensile strength	maximum bundle diameter	pkg. qty.
9920	5"	18 lbs	1 3/8"	100



Nylon Mounting Cable Ties

Mounting tab cable ties have a molded-in screw hole for securing bundles of wire on virtually any surface that has or can accept a drilled hole. Up to a 1/4" screw size can be used, or a comparable rivet size. All mounting tab cable ties are manufactured from durable nylon 6/6. Recognized under the Component Program of Underwriters Laboratories Inc. for use at temperatures not exceeding 85°C (185°F). Meets UL94V-2 Flammability Classification.



standard natural

part no.	approx. length	approx. width	loop tensile strength	max. dia.	screw size	pkg. qty.
9757	6 1/2"	.170"	50 lbs	1 3/4"	10	100
9758	8"	.170"	50 lbs	2 3/8"	10	100
9760	11"	.170"	50 lbs	3"	10	100

standard UV-resistant black

part no.	approx. length	approx. width	loop tensile strength	max. dia.	screw size	pkg. qty.
9651	6 1/2"	.170"	50 lbs	1 3/4"	10	100
9653	8"	.170"	50 lbs	2"	10	100
9655	11"	.170"	50 lbs	3"	10	100

heavy-duty natural

part no.	approx. length	approx. width	loop tensile strength	max. dia.	screw size	pkg. qty.
9765	15"	.295"	120 lbs	4"	1/4"	100
9766	22"	.310"	120 lbs	6"	1/4"	100
9767	29"	.310"	120 lbs	8"	1/4"	100

heavy-duty UV-resistant black

part no.	approx. length	approx. width	loop tensile strength	max. dia.	screw size	pkg. qty.
9657	15"	.295"	120 lbs	4"	1/4"	100
9659	22"	.310"	120 lbs	6"	1/4"	100
9661	29"	.310"	120 lbs	8"	1/4"	100



Identification Ties

Fasten and identify bundles with these identification ties. Manufactured from durable nylon 6/6. The marking area has a matte finish to readily accept ink for clear identification. Meets UL94V-2 Flammability Classification. For use at temperatures not exceeding 85°C (185°F).



Scan for pricing or go to www.delcity.net/catalogpricing

part no.	approx. length	maximum pad size	loop tensile strength	maximum bundle diameter	pkg. qty.
9928	8"	1" x 7/16"	50 lbs	1 3/4"	100



Stainless Steel Cable Ties

These cable ties feature a self-locking ball mechanism that meets low insertion force. Stainless steel ties produce little to no oxidation which makes them great for clean environments. These ties are manufactured from 304 stainless steel and are designed for harsh, corrosive and salt-water environments. Resistant to chemicals, radiation exposure and rated for temperatures up to 300°C (572°F).

part no.	approx. length	approx. width	loop tensile strength	max. dia.	pkg. qty.
9201	6"	.176"	100 lbs	1 1/2"	10
9203	11"	.176"	100 lbs	3 3/4"	10



Grip Strip™ Cord Organizers

These cord organizers are reusable Velcro® strips that fasten wires and cables into an organized bundle. The cinch tab allows the Grip Strip™ to attach to a cable or cord and the Velcro® surface provides adjustment of various bundle sizes. The one piece design allows the excess to stick to itself. Ideal for home, office or electrical tool and appliance cords.

part no.	approx. length	approx. width	pkg. qty.
9930	8"	.518"	5
9932	11"	.518"	5



Push-mount Bases

Push-mount bases install easily into any 1/4" hole. Centering ears and a locking bar design hold them securely in place. Made with durable nylon 6/6, they can be used on all self-locking ties up to 14" and 75 lbs tensile strength. Recognized under the Component Program of Underwriters Laboratories Inc. Meets UL94V-2 Flammability Classification for use at temperatures not exceeding 85°C (185°F).

push-mount bases

part no.	base dimension	screw hole size	color	pkg. qty.
9773	5/16" x 9/16"	1/4"	natural	100
9812	5/16" x 9/16"	1/4"	black	100

cable ties & wire fasteners



Scan for pricing or go to www.delcity.net/catalogpricing



Screw Mount Bases

These mounting bases feature a low-profile for use where height is limited. The counter-sunk hole ensures that the screw or rivet will not interfere with your cable tie. These 4-way entry screw mount bases can be used on all self-locking ties up to 14" and 75 lbs tensile strength. Bases are made with durable nylon 6/6. Recognized under the Component Program of Underwriters Laboratories Inc. Meets UL94V-2 Flammability Classification for use at temperatures not exceeding 85°C (185°F).

4-way entry

part no.	base dimension	screw hole size	color	pkg. qty.
9770	1 1/8" x 1 1/8"	#10	natural	100
9870	1 1/8" x 1 1/8"	#10	black	100



Screw Mount Bases

These mounting bases feature a narrow and higher design for crowded surface areas. Their deep cradle design provides extra support for large bundles. They can be used on all standard and heavy-duty ties up to 48" and 175 lbs tensile strength. Screw hole size: 1/4". Bases are made with durable nylon 6/6. Recognized under the Component Program of Underwriters Laboratories Inc. Meets UL94V-2 Flammability Classification for use at temperatures not exceeding 85°C (185°F).

2-way entry

part no.	base dimension	screw hole size	color	pkg. qty.
9774	5/8" x 7/8"	1/4"	natural	100
9817	5/8" x 7/8"	1/4"	black	100



9772



9801



9871

Adhesive Bases

Adhesive bases can be attached to a clean and dry surface of metal, plastic, glass, paper or painted surfaces. A screw or rivet is recommended for extra holding strength against outdoor elements. The 2-way and 4-way adhesive bases can be used on all self-locking ties up to 14" and 75 lbs tensile strength. Bases are made with durable nylon 6/6 and acrylic adhesive. The counter-sunk hole for the screw or rivet will not interfere with the cable ties. Meets UL94V-2 Flammability Classification. For use at temperatures not exceeding 85°C (185°F).

2-way entry

part no.	base dimension	color	pkg. qty.
9800	1" x 1"	natural	100
9801	1" x 1"	black	100

4-way entry

part no.	base dimension	color	pkg. qty.
9772	3/4" x 3/4"	natural	100
9806	3/4" x 3/4"	black	100
9771	1 1/8" x 1 1/8"	natural	100
9871	1 1/8" x 1 1/8"	black	100

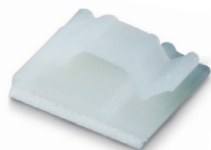

Cord Clips

These nylon 6/6 clips are perfect for wire, cord and cable bundles from 1/8"-3/8". The extra wide spring arm with reinforced stress points adds strength and durability. The adhesive base allows for quick installation for light-duty applications. For use at temperatures not exceeding 85°C (185°F).

natural

part no.	wire capacity	overall height	base dimensions	pkg. qty.
9775	1/8" x 1/4"	1/4"	5/8" x 5/8"	100
9776	3/16"	5/16"	5/8" x 5/8"	100
9777	1/4"	3/8"	5/8" x 5/8"	100
9778	3/8"	1/2"	3/4" x 3/4"	100

black

part no.	wire capacity	overall height	base dimensions	pkg. qty.
9824	1/8" x 1/4"	1/4"	5/8" x 5/8"	100
9826	3/16"	5/16"	5/8" x 5/8"	100
9827	1/4"	3/8"	5/8" x 5/8"	100
9828	3/8"	1/2"	3/4" x 3/4"	100



Scan for pricing or go to www.delcity.net/catalogpricing



Cable Wraptor™

Provide an ideal solution for all of your cord or cable bundling applications. The "T" handle with mounting hole provides a comfortable carrying grip and easily hangs for storage. The large and evenly spaced teeth design ensures a strong and secure locking system. It is manufactured from durable impact resistant plastic with stainless steel hinge pin.

For a complete list of kit components, see page 331.

part no.	description	clamp diameter	max load*
989599	mini	1"	25 lbs
989600	medium	2"	50 lbs
989602	large	3"	100 lbs
989604	x-large	4"	150 lbs
989605	kit	1" - 4"	25 - 150 lbs

* Max load shown is for reference only. Actual sustainable load varies based on application.



Nylon Cable Clamps

These nylon 6/6 clamps are tough, resilient, lightweight and resistant to aging and most chemicals. Mounting hole is 13/64" in diameter. Recognized under the Component Program of Underwriters Laboratories Inc. Meets UL flammability, classification UL94V-2. For use at temperatures not exceeding 85°C (185°F).



natural nylon

part no.	suggested clamping diameter	pkg. qty.	part no.	suggested clamping diameter	pkg. qty.
2402	1/8"	100	2410	5/8"	100
2403	3/16"	100	2412	3/4"	100
2404	1/4"	100	2416	1"	100
2406	3/8"	100	2424	1 1/2"	100
2408	1/2"	100			

black

part no.	suggested clamping diameter	pkg. qty.	part no.	suggested clamping diameter	pkg. qty.
2502DL	1/8"	100	2510	5/8"	100
2503DL	3/16"	100	2512	3/4"	100
2504DL	1/4"	100	2516	1"	100
2506	3/8"	100	2524	1 1/2"	100
2508	1/2"	100			



9610



9620

Body Clips

These body clips are made from heat-treated spring steel and feature a black corrosion-resistant finish. Simply snap in place to securely hold wires, cables and hoses.



.290" approx. size

small body clip



.470" approx. size

medium body clip

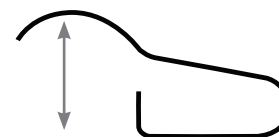

.570" approx. size

large body clip

plastic coated tongue

part no.	size	pkg. qty.
9610	small 1/8"	100
9611	medium 3/16"	100
9612	large 1/4"	100

plain tongue

part no.	size	pkg. qty.
9620	small 1/8"	100
9621	medium 3/16"	100
9622	large 1/4"	100



Mechanics Wire

Mechanics wire is a 19-gauge soft annealed steel wire that can be easily bent, molded or configured and is designed for use in emergency or temporary-fix situations. It is most commonly used for repairing a broken clamp, fastener or other general automotive quick fix applications. Available in 50' spools, having mechanics wire in your trunk may help you get home.

part no.	description	reel size
12202200	mechanics wire	50'

loom & loom clamps

Split Loom (High Rise Ridge)

Convolution split loom is one of the most popular conduits for holding groups of wires in position and protecting them against abrasion or crushing. It contains a split for easy insertion of wires over a long run, but remains closed or overlaps when bent or twisted. Quality control throughout its extrusion allows for uniform thickness for the entire run length. All split loom marked by an asterisk (*) can be shipped LTL FREIGHT ONLY. Temperature range: -40°C to 93°C (-40°F to 200°F).



Scan for pricing or go to www.delcity.net/catalogpricing



Material Specifications

Material
Polyethylene

Standard Color
Black

Operating Range
-40°C to 93°C
(-40°F to 200°F)

Use With
cable clamps
PAGES 38-39



¼" I.D.

part no.	foot per box	approx lbs per box
783	100'	3
1783	250'	6
1923	3,200'	27
1823*	25,000'	168

1" I.D.

part no.	foot per box	approx lbs per box
1790	75'	8
1930	300'	22
1830*	2,250'	146

¾" I.D.

part no.	foot per box	approx lbs per box
784	100'	3
1784	250'	8
1924	1,900'	29
1824*	15,000'	161

1¼" I.D.

part no.	foot per box	approx lbs per box
1932	250'	24
1831*	1,800'	148

½" I.D.

part no.	foot per box	approx lbs per box
786	100'	4
1786	250'	8
1926	1,100'	29
1826*	8,500'	187

1½" I.D.

part no.	foot per box	approx lbs per box
1934	150'	12
1833*	1,000'	122

⅝" I.D.

part no.	foot per box	approx lbs per box
788	100'	4
1788	250'	10
1928	800'	27
1828*	5,500'	154

2" I.D.

part no.	foot per box	approx lbs per box
1936	100'	8
1836*	800'	141

¾" I.D.

part no.	foot per box	approx lbs per box
789	50'	3
1789	150'	9
1929	550'	23
1829*	4,200'	155

2½" I.D.

part no.	foot per box	approx lbs per box
1838*	500'	131

* #1838 is special order; non-stock

INFORMATION

PROTECTION:

Convolution split loom provides protection from heat, sunlight, water, snow, ice, friction wear, fraying and puncture. It provides an efficient method of wire harness assembly while protecting and reducing installation damage to valuable wiring circuits.

USES:

- Automotive, Trucks, Buses,
- Trailers & RV's
- Lawn, garden & home appliance
- Agricultural equipment
- Heavy equipment
- Computer & electronics
- Aircraft & Military
- Marine

Packaging Options



700 Part Number Series
100-75-50 Ft. Box
42" x 20" x 19.5"
can be shipped UPS



1700 Part Number Series
250-150-75 Ft. Box
8" x 25" x 24"
can be shipped UPS



1900 Part Number Series
Prepackaged Box
21" x 21" x 23"
can be shipped UPS
(UPS dimensional up-charge applies)



1800 Part Number Series
Gaylord Box
shipped LTL Freight Only

loom & loom clamps



Material Specifications

Material
High Temperature
Heat Stabilized Nylon

Standard Color
Black with Gray Stripe

Operating Range
-40°C to 149°C
-40°F to 300°F

High Temperature Split Loom (High Rise Ridge)

This loom was originally developed for ambulance and fire equipment manufacturers where operation in a high heat environment is critical. Also used in many other industries where a high heat environment exists. High temperature loom is distinctly marked with a gray stripe running the entire length. Temperature range: -40°C to 149°C (-40°F to 300°F). All convoluted loom marked by an asterisk (*) can be shipped LTL FREIGHT ONLY.



Scan for pricing or go to www.delcity.net/catalogpricing

1/4" I.D.

part no.	foot per box	approx lbs per box
773	100'	2
1773	250'	6
1903	3,200'	29
1803*	28,000'	178

5/8" I.D.

part no.	foot per box	approx lbs per box
778	100'	4
1778	250'	10
1908	800'	21
1808*	5,500'	166

3/8" I.D.

part no.	foot per box	approx lbs per box
774	100'	3
1774	250'	8
1904	1,900'	27
1804*	15,000'	168

3/4" I.D.

part no.	foot per box	approx lbs per box
779	50'	3
1779	150'	9
1909	550'	28
1809*	4,200'	155

1/2" I.D.

part no.	foot per box	approx lbs per box
776	100'	4
1776	250'	8
1906	1,100'	27
1806*	8,500'	188

1" I.D.

part no.	foot per box	approx lbs per box
1780	75'	3½
1910	300'	8
1810*	2,250'	142

1¼" I.D.

part no.	foot per box	approx lbs per box
1811*	1,800'	175

#1811 is special order; non-stock

Packaging Options



700 Part Number Series
100-75-50 Ft. Box
42" x 20" x 19.5"
can be shipped UPS



1700 Part Number Series
250-150-75 Ft. Box
8" x 25" x 24"
can be shipped UPS



1900 Part Number Series
Prepackaged Box
21" x 21" x 23"
can be shipped UPS
(UPS dimensional up-charge applies)



1800 Part Number Series
Gaylord Box
shipped LTL Freight Only



Loom Insertion Tool

When you want an easier way to feed a bundle of wires into corrugated split loom, reach for one of these loom insertion tools. To use, simply twist the white portion so that its cut-out matches the orange portion cut-out. Lay your wires inside, then twist to 'lock' wires in place. Insert the angled portion into the split loom, and slide the tool along the length of the split loom run. When complete, unlock the wires by twisting the tool again. Perfect for repetitive applications. **For complete listing of kit components, see page 320.**

part no.	I.D. size
909900	loom insertion tool, 1/4"-7/16"
909905	loom insertion tool, 1/2"-5/8"
909910	loom insertion tool, 3/4"-7/8"
909915	loom insertion tool, 1"-1¼"
909920	loom insertion tool kit, 1/4" - 1¼"

INSTALLATION



loom & loom clamps

Flame Retardant Split Loom (High Rise Ridge)

This loom is manufactured to meet the stringent requirements of the marine and emergency vehicle industries, where extra protection is demanded. Meets UL94V-2 rating for flame retardancy. The high rise ridge offers greater flexibility without twisting, tangling or separating. Polypropylene loom is marked with a blue stripe running the entire length. Temperature range: -40°C to 135°C (-40°F to 275°F). All convoluted loom marked by an asterisk (*) can be shipped LTL FREIGHT ONLY.



Scan for pricing or go to www.delcity.net/catalogpricing



Material Specifications

Material
Flame Retardant Polypropylene

Standard Color
Black with Blue Stripe

Operating Range
-40°C to 135°C
-40°F to 275°F

1/4" I.D.

part no.	foot per box	approx lbs per box
763	100'	3
1763	250'	6
1913	3,200'	29
1813*	25,000'	170

5/8" I.D.

part no.	foot per box	approx lbs per box
768	100'	4
1768	250'	10
1918	750'	20
1818*	5,500'	168

3/8" I.D.

part no.	foot per box	approx lbs per box
764	100'	3
1764	250'	8
1914	1,800'	25
1814*	15,000'	168

3/4" I.D.

part no.	foot per box	approx lbs per box
769	50'	3
1769	150'	9
1919	500'	28
1819*	4,200'	150

1/2" I.D.

part no.	foot per box	approx lbs per box
766	100'	4
1766	250'	8
1916	1,100'	27
1816*	8,000'	187

1" I.D.

part no.	foot per box	approx lbs per box
1770	75'	4
1920	300'	8
1820*	2,250'	142

Packaging Options



700 Part Number Series
100-75-50 Ft. Box
42" x 20" x 19.5"
can be shipped UPS



1700 Part Number Series
250-150-75 Ft. Box
8" x 25" x 24"
can be shipped UPS



1900 Part Number Series
Prepackaged Box
21" x 21" x 23"
can be shipped UPS
(UPS dimensional up-charge applies)



1800 Part Number Series
Gaylord Box
shipped LTL Freight Only

Nylon Cable Clamps

These nylon 6/6 clamps are tough, resilient, lightweight and resistant to aging and most chemicals. The mounting hole is 13/64" diameter. Clamps meet UL flammability, classification UL94V-2. They are recognized under the Component Program of Underwriters Laboratories Inc. For use at temperatures not exceeding 85°C (185°F).



natural nylon

part no.	suggested clamping diameter	pkg. qty.	part no.	suggested clamping diameter	pkg. qty.
2402	1/8"	100	2410	5/8"	100
2403	3/16"	100	2412	3/4"	100
2404	1/4"	100	2416	1"	100
2406	3/8"	100	2424	1 1/2"	100
2408	1/2"	100			

black



part no.	suggested clamping diameter	pkg. qty.	part no.	suggested clamping diameter	pkg. qty.
2503DL	3/16"	100	2510	5/8"	100
2504DL	1/4"	100	2512	3/4"	100
2506	3/8"	100	2516	1"	100
2508	1/2"	100	2524	1 1/2"	100

Loom Accessories

These accessory clips and tees allow a user to branch a portion of wires or to secure a section of wires to a stationary object. Temperature range: -40°C to 125°C (-40°F to 257°F).



accessory clip 2039-2043



accessory clip 2053



tee 2019-2027

accessory clips

part no.	conduit size	sheet metal thickness (mm)
2039	.350"	3.8
2041	.413"/.500"	3.8
2043	.625"	3.8
2053	.750"	3.8

tees

part no.	conduit size		
	left	center	right
2019	.413"/.500"	.413"/.500"	.413"/.500"
2025DL	.750"	.500"	.750"
2027	.350"	.350"	.413"



Scan for pricing or go to www.delcity.net/catalogpricing



Woven Cotton, Asphalt Coated Fabric Loom

Asphalt coated and constructed of a twisted paper and cotton-polyester blend weave. The tubing is saturated with an asphalt compound to bind the weave and prevent moisture absorption. It is ideal for use in harsh environments. Temperature rating: 135°C (275°F). SAE J-562A Ford ESBM3L38A, Chrysler MS542, GM 675, 676, 677, 678M, HHT791A, B, C.

part no.	size I.D.	foot per box	lbs per box	part no.	size I.D.	foot per box	lbs per box
701DL	3/16"	100'	2	706DL	1/2"	100'	5 1/2
1701*	3/16"	2,500'	31	1706*	1/2"	1,000'	40
702DL	1/4"	100'	2 1/2	707DL	9/16"	100'	6
1702*	1/4"	2,000'	33	1707*	9/16"	500'	39
703DL	5/16"	100'	3	708DL	5/8"	100'	7
1703*	5/16"	2,000'	44	1708*	5/8"	500'	31
704DL	3/8"	100'	4 1/2	709DL	3/4"	100'	9
1704*	3/8"	1,000'	31	1709*	3/4"	250'	39
705DL	7/16"	100'	4 1/2	710DL	7/8"	100'	12
1705*	7/16"	1,000'	35	1710*	7/8"	250'	27

* bulk packaging will contain multiple splices.

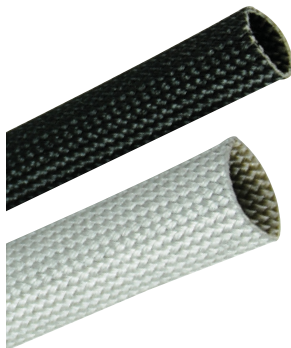

High Temp Braided Fiberglass Sleeveing

The heavy-weight fiberglass sleeveing is coated with a resin material to deflect or encapsulate hot temperatures from damaging your sensitive wire, harness or hose. It is also extremely resistant to abrasion, gasoline and other engine chemicals. The loom is easily cut with a pair of scissors without the ends fraying and extraordinarily maintains a tight cohesion under heavy vibration, mechanical stress and several temperature variations. Temperature rating: 649°C (1200°F).

part no.	color	size I.D.	foot per box	lbs per box
642	black	1/4"	50'	1 1/2
644	black	1/2"	50'	3
646	black	3/4"	50'	4
648	black	1"	25'	3
682	silver	1/4"	50'	1 1/2
684	silver	1/2"	50'	3
686	silver	3/4"	50'	4
688	silver	1"	25'	3

loom & loom clamps



Scan for pricing or go to www.delcity.net/catalogpricing



Expandable PET Sleeving

This polyethylene terephthalate sleeving is an ideal cover for outboard motor cables, marine hoses, trailer chains and harness assemblies. To cut this expandable sleeving, use a professional heat tool (#990070). The I.D. size is measured at a relaxed state; it expands to 2 times its original size. Manufactured to meet UL, CSA and FMVSS 302 requirements. Operating temperature: -70°C to 125°C (-94°F to 257°F).

part no.	size I.D.	foot per box	lbs per box	part no.	size I.D.	foot per box	lbs per box
841	1/8"	200'	1	845	3/4"	75'	2
842	1/4"	200'	1	1845	3/4"	250'	3
1842	1/4"	1,000'	3	846	1 1/4"	50'	1
843	3/8"	100'	1	1846	1 1/4"	250'	4
1843	3/8"	500'	3	847	1 1/2"	50'	1
844	1/2"	100'	1	1847	1 1/2"	200'	5
1844	1/2"	500'	4	848	1 3/4"	50'	2
				1848	1 3/4"	200'	6

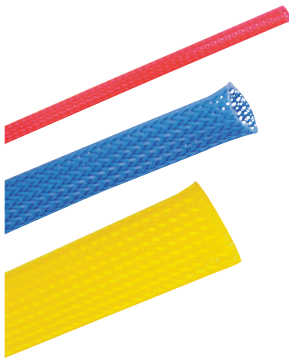

Colored Expandable PET Sleeving

Ditch the standard black loom and customize your next harness installation job. This colored expandable loom offers the same high quality construction of black expandable loom, 10 mil polyethylene terephthalate material and expands up to 2 times the I.D. size. To cut this expandable sleeving, use a professional heat tool (#990070). Operating temperature: -70°C to 125°C (-94°F to 257°F).

part no.	color	size I.D.	foot per box	lbs per box
822DL	blue	1/4"	200'	1
824	blue	1/2"	100'	1
826	blue	3/4"	75'	2
828	blue	1 1/4"	50'	1
862	red	1/4"	200'	1
864	red	1/2"	100'	1
866	red	3/4"	75'	2
868	red	1 1/4"	50'	1
882	yellow	1/4"	200'	1
884	yellow	1/2"	100'	1
886	yellow	3/4"	75'	2
888	yellow	1 1/4"	50'	1



Braided Self-Wrap PET Sleeving

This sleeving simply self-closes around a group of wires. The semi-rigid braiding is stretchy and springy, allowing wires to be pulled out or new ones inserted repeatedly if necessary. It's flexible enough to bend to a tight radius without distorting or splitting open and, unlike rigid split loom, will not impair or affect the flexibility of the wires. To cut this sleeving, use a professional heat tool (#990070). The PET material is halogen free and meets UL 94V-0. It retains its shape and rigidity from -70°C to 125°C (-94°F to 257°F).

part no.	size I.D.	foot per box	lbs per box
851	1/8"	100'	1 1/2
852	1/4"	100'	1 1/2
854	1/2"	75'	2
855	3/4"	50'	2
856	1"	50'	3

loom & loom clamps

Woven Loom   



Woven flexible self-wrap closes around a group of cables, wires, or cords all by itself. It has extra overlap to provide complete protection for harnesses. The superior elastic flexibility allows for tight radius bends without distorting the wire. The soft material and the high abrasion resistance makes the self-wrap ideal for high vibration locations. It's more flexible than split loom and more durable than spiral wrap. The self-wrapping material allows for easy installation and wire removal. The self-wrap retains its shape and rigidity from -70°C to 125°C (-94°F to 257°F). Meets MIL-I-23053, cut and abrasion resistant. RoHS, CSA/UL approved.



Scan for pricing or go to www.delcity.net/catalogpricing

part no.	size I.D.	aprox. wall thickness	foot per box	lbs per box
830	3/16"	.027"	200	2
831	3/8"	.027"	100	1.5
832	1/2"	.027"	75	1.3
833	3/4"	.027"	50	1.25
834	1"	.027"	50	1.5

NEW

Heat Shrink Loom



 RoHS

Heatshrink Fabric Loom is a unique mixture of Polyolefin and Polyester yarns and shrinks to 1/2 its original diameter. It's designed primarily to provide mechanical abrasion protection for components such as rubber hoses, plastic pipes and harness wiring bundles. Provides outstanding abrasion, chafing and cutting protection, even at high temperatures. Its woven construction makes it highly flexible and resistant to trapping water, heat and humidity. Shrink temperature is 176° (80°C).

1/2" I.D.

part no.	foot per box	lbs per box	unshrunk diameter	shrunk diameter
1730	100	1.15	12mm	6mm
1731	25	0.2875	12mm	6mm

3/4" I.D.

part no.	foot per box	lbs per box	unshrunk diameter	shrunk diameter
1732	100	1.61	20mm	10mm
1733	25	0.4025	20mm	10mm

1 3/16" I.D.

part no.	foot per box	lbs per box	unshrunk diameter	shrunk diameter
1734	100	1.6	30mm	15mm
1735	25	0.4	30mm	15mm

1 1/2" I.D.

part no.	foot per box	lbs per box	unshrunk diameter	shrunk diameter
1736	100	1.6	40mm	20mm
1737	25	0.4	40mm	20mm

loom & loom clamps

Spiral-cut Loom

A spiral-cut in this loom allows wires to stay in place or be pulled out if needed. It is made of low density polyethylene. Temperature rating: -35°C to 73°C (-30°F to 165°F).



Scan for pricing or go to www.delcity.net/catalogpricing



natural

part no.	size O.D.	foot per box	lbs per box
722DL*	¼"	100'	2
726*	½"	100'	4
1722	¼"	1,000'	12
1726	½"	500'	18

* items shipped on spool

black

part no.	size O.D.	foot per box	lbs per box
622*	¼"	100'	2
626*	½"	100'	4
628*	¾"	50'	8
1622	¼"	1,000'	12
1626	½"	500'	18
1628	¾"	500'	14

Nylon Cable Clamps

These nylon 6/6 clamps are tough, resilient, lightweight and resistant to aging and most chemicals. The mounting hole is 13/64" diameter. Clamps meet UL flammability, classification UL94V-2. They are recognized under the Component Program of Underwriters Laboratories Inc. For use at temperatures not exceeding 85°C (185°F).

natural nylon

part no.	suggested clamping diameter	pkg. qty.	part no.	suggested clamping diameter	pkg. qty.
2402	1/8"	100	2410	5/8"	100
2403	3/16"	100	2412	3/4"	100
2404	¼"	100	2416	1"	100
2406	3/8"	100	2424	1½"	100
2408	½"	100			

black

part no.	suggested clamping diameter	pkg. qty.	part no.	suggested clamping diameter	pkg. qty.
2503DL	3/16"	100	2510	5/8"	100
2504DL	¼"	100	2512	¾"	100
2506	3/8"	100	2516	1"	100
2508	½"	100	2524	1½"	100

Carbon Steel Plated Loom Clamps

Carbon steel plated cable clamps with zinc/gold chromate have a removable EPDM jacket. Mounting hole is .406" with .375" stud. Width of steel is .630". Carbon steel has a higher ductility and is less susceptible to fatigue.



part no.	size closed I.D.	mounting lines O.D.		SAE size	part no.	size closed I.D.	mounting lines O.D.		SAE size
		min.	max.				min.	max.	
200403	¼"	3/16"	¼"	004	202003	1¼"	1½"	1¼"	020
200603	3/8"	¼"	5/8"	006	202203	1¾"	1¼"	1¾"	022
200803	½"	3/8"	½"	008	202403	1½"	1¾"	1½"	024
201003	5/8"	½"	5/8"	010	202603	1½"	1½"	1½"	026
201203	¾"	5/8"	¾"	012	202803	1¾"	1½"	1¾"	028
201403	7/8"	¾"	7/8"	014	203003	1¾"	1¾"	1¾"	030
201603	1"	7/8"	1"	016	203203	2"	1¾"	2"	032
201803	1½"	1"	1½"	018					

Min qty: 10

Loom Clamps

Plated steel, stainless steel and aluminum clamps have a removable EPDM cushion to help reduce vibration while protecting the loom or cables. Typical applications include holding hydraulic hoses, wire harnesses and cables. The mounting hole is $\frac{1}{64}$ " for $\frac{1}{4}$ " screws or bolts



Scan for pricing or go to www.delcity.net/catalogpricing



zinc plated SPCC-5D steel clamps (EPDM removable jacket)

part no.	size closed I.D.	bundle lines O.D.		SAE size	part no.	size closed I.D.	bundle lines O.D.		SAE size
		min.	max.				min.	max.	
2004*	$\frac{1}{4}$ "	$\frac{3}{16}$ "	$\frac{1}{4}$ "	004	2024	1 $\frac{1}{2}$ "	1 $\frac{3}{8}$ "	1 $\frac{1}{2}$ "	024
2006*	$\frac{3}{8}$ "	$\frac{1}{4}$ "	$\frac{5}{8}$ "	006	2026	1 $\frac{5}{8}$ "	1 $\frac{1}{2}$ "	1 $\frac{5}{8}$ "	026
2008*	$\frac{1}{2}$ "	$\frac{3}{8}$ "	$\frac{1}{2}$ "	008	2028	1 $\frac{3}{4}$ "	1 $\frac{5}{8}$ "	1 $\frac{3}{4}$ "	028
2010*	$\frac{5}{8}$ "	$\frac{1}{2}$ "	$\frac{5}{8}$ "	010	2030	1 $\frac{7}{8}$ "	1 $\frac{3}{4}$ "	1 $\frac{7}{8}$ "	030
2012*	$\frac{3}{4}$ "	$\frac{5}{8}$ "	$\frac{3}{4}$ "	012	2032	2"	1 $\frac{7}{8}$ "	2"	032
2014*	$\frac{7}{8}$ "	$\frac{3}{4}$ "	$\frac{7}{8}$ "	014	2034	2 $\frac{1}{8}$ "	2"	2 $\frac{1}{8}$ "	034
2016*	1"	$\frac{7}{8}$ "	1"	016	2036	2 $\frac{1}{4}$ "	2 $\frac{1}{8}$ "	2 $\frac{1}{4}$ "	036
2018	1 $\frac{1}{8}$ "	1"	1 $\frac{1}{8}$ "	018	2038	2 $\frac{3}{8}$ "	2 $\frac{1}{4}$ "	2 $\frac{3}{8}$ "	038
2020	1 $\frac{1}{4}$ "	1 $\frac{1}{8}$ "	1 $\frac{1}{4}$ "	020	2040	2 $\frac{1}{2}$ "	2 $\frac{3}{8}$ "	2 $\frac{1}{2}$ "	040
2022	1 $\frac{3}{8}$ "	1 $\frac{1}{4}$ "	1 $\frac{3}{8}$ "	022	2048	3"	2 $\frac{7}{8}$ "	3"	048

* Min qty: 100; all others min qty: 10



SUS304 stainless steel clamps (EPDM removable jacket)

part no.	size closed I.D.	bundle lines O.D.		SAE size	part no.	size closed I.D.	bundle lines O.D.		SAE size
		min.	max.				min.	max.	
200409	$\frac{1}{4}$ "	$\frac{3}{16}$ "	$\frac{1}{4}$ "	004	202209	1 $\frac{3}{8}$ "	1 $\frac{1}{4}$ "	1 $\frac{3}{8}$ "	022
200609	$\frac{3}{8}$ "	$\frac{1}{4}$ "	$\frac{3}{8}$ "	006	202409	1 $\frac{1}{2}$ "	1 $\frac{3}{8}$ "	1 $\frac{1}{2}$ "	024
200809	$\frac{1}{2}$ "	$\frac{3}{8}$ "	$\frac{1}{2}$ "	008	202609	1 $\frac{5}{8}$ "	1 $\frac{1}{2}$ "	1 $\frac{5}{8}$ "	026
201009	$\frac{5}{8}$ "	$\frac{1}{2}$ "	$\frac{5}{8}$ "	010	202809	1 $\frac{3}{4}$ "	1 $\frac{5}{8}$ "	1 $\frac{3}{4}$ "	028
201209	$\frac{3}{4}$ "	$\frac{5}{8}$ "	$\frac{3}{4}$ "	012	203009	1 $\frac{7}{8}$ "	1 $\frac{3}{4}$ "	1 $\frac{7}{8}$ "	030
201409	$\frac{7}{8}$ "	$\frac{3}{4}$ "	$\frac{7}{8}$ "	014	203209	2"	1 $\frac{7}{8}$ "	2"	032
201609	1"	$\frac{7}{8}$ "	1"	016	204009	2 $\frac{1}{2}$ "	2 $\frac{3}{8}$ "	2 $\frac{1}{2}$ "	040
201809	1 $\frac{1}{8}$ "	1"	1 $\frac{1}{8}$ "	018	204809	3"	2 $\frac{7}{8}$ "	3"	048
202009	1 $\frac{1}{4}$ "	1 $\frac{1}{8}$ "	1 $\frac{1}{4}$ "	020					

Min qty: 10



5052 aluminum clamps (EPDM removable jacket)

part no.	size closed I.D.	bundle lines O.D.		SAE size	part no.	size closed I.D.	bundle lines O.D.		SAE size
		min.	max.				min.	max.	
2804*	$\frac{1}{4}$ "	$\frac{3}{16}$ "	$\frac{1}{4}$ "	004	2816*	1"	$\frac{7}{8}$ "	1"	016
2806*	$\frac{3}{8}$ "	$\frac{1}{4}$ "	$\frac{3}{8}$ "	006	2820	1 $\frac{1}{4}$ "	1 $\frac{1}{8}$ "	1 $\frac{1}{4}$ "	020
2808*	$\frac{1}{2}$ "	$\frac{3}{8}$ "	$\frac{1}{2}$ "	008	2824	1 $\frac{1}{2}$ "	1 $\frac{3}{8}$ "	1 $\frac{1}{2}$ "	024
2810*	$\frac{5}{8}$ "	$\frac{1}{2}$ "	$\frac{5}{8}$ "	010	2832	2"	1 $\frac{7}{8}$ "	2"	032
2812*	$\frac{3}{4}$ "	$\frac{5}{8}$ "	$\frac{3}{4}$ "	012	2840	2 $\frac{1}{2}$ "	2 $\frac{3}{8}$ "	2 $\frac{1}{2}$ "	040
2814*	$\frac{7}{8}$ "	$\frac{3}{4}$ "	$\frac{7}{8}$ "	014					

* Min qty: 100; all others min qty: 10



vinyl-coated SPCC-5D steel clamps

part no.	size closed I.D.	bundle lines O.D.		SAE size	part no.	size closed I.D.	bundle lines O.D.		SAE size
		min.	max.				min.	max.	
2904*	$\frac{1}{4}$ "	$\frac{3}{16}$ "	$\frac{1}{4}$ "	004	2916*	1"	$\frac{7}{8}$ "	1"	016
2906*	$\frac{3}{8}$ "	$\frac{1}{4}$ "	$\frac{3}{8}$ "	006	2920	1 $\frac{1}{4}$ "	1 $\frac{1}{8}$ "	1 $\frac{1}{4}$ "	020
2908*	$\frac{1}{2}$ "	$\frac{3}{8}$ "	$\frac{1}{2}$ "	008	2924	1 $\frac{1}{2}$ "	1 $\frac{3}{8}$ "	1 $\frac{1}{2}$ "	024
2910*	$\frac{5}{8}$ "	$\frac{1}{2}$ "	$\frac{5}{8}$ "	010	2932	2"	1 $\frac{7}{8}$ "	2"	032
2912*	$\frac{3}{4}$ "	$\frac{5}{8}$ "	$\frac{3}{4}$ "	012	2940	2 $\frac{1}{2}$ "	2 $\frac{3}{8}$ "	2 $\frac{1}{2}$ "	040
2914*	$\frac{7}{8}$ "	$\frac{3}{4}$ "	$\frac{7}{8}$ "	014					

* Min qty: 100; all others min qty: 10

loom & loom clamps

Liquid Tight Strain Relief Cord Connectors

These cord connectors are used to secure a power supply cord to a piece of electrical equipment. Provides a liquid-tight seal on your power cord entry and reduces wire stress at connection point. Choose from standard dome nut for strain relief or flex nut type, which includes the strain relief to help prevent cable kinking. Designed with vibration-proof protection up to 70 psi. Internationally approved to UL, CSA, VDE and SVE specifications. Seal meets IP68 requirements and is suitable for NEMA 4 and 6 connectors. Manufactured from nylon material with a TPE gland seal to help resist dust, salt water, weak acids, weak alkalis, alcohol, ester, ketone, ether, benzene, gas, mineral and animal and vegetable oils. NPT (National Pipe Thread) is the North American standard. PG is the European standard. Operating temp: -30°C to 100°C (-22°F to 212°F).



Scan for pricing or go to www.delcity.net/catalogpricing



NPT style hub standard type

part no.	standard size	diameter range	max hole clearance	overall length
2638	3/8"	.157"-.314"	.675"	1.692"
2612	1/2"	.236"-.472"	.825"	1.734"
2634DL	3/4"	.511"-.708"	1.050"	1.969"
2601	1"	.709"-1.024"	1.303"	2.283"

* Nuts sold separately



NPT style hub flex type

part no.	standard size	diameter range	max hole clearance	overall length
2738	3/8"	.157"-.314"	.561"	3.282"
2712	1/2"	.236"-.472"	.825"	4.135"
2734	3/4"	.511"-.708"	1.050"	5.333"

* Nuts sold separately



NPT style locking nuts

part no.	standard size	description	mates with
2639	3/8"	locking nut	2638
2613	1/2"	locking nut	2612
2635	3/4"	locking nut	2634
2602DL	1"	locking nut	2601



PG style hub standard type with nut

part no.	standard size (PG#)	diameter range	max hole clearance	overall length
2650	3/8" (9)	.181"-.312"	.599"	1.300"
2653	1/2" (13.5)	.170"-.450"	.804"	1.530"
2656	3/4" (21)	.450"-.705"	1.115"	1.870"
2659	1" (29)	.590"-.990"	1.470"	2.230"



Expandable Tubing Hot Knife

Expandable sleeving should be cut with a hot knife cutting tool or similar heated blade to keep the material fibers together. This bench mount 110 volt AC tool enables the operator to draw flexible sleeving down across the knife blade under tension. Both hands are then free to seal and flare ends. Must be used in a well ventilated area. Instructions are printed on the tool.

part no.	description
990070	expandable tubing hot knife



Scan for pricing or go to www.delcity.net/catalogpricing



PVC 2:1 Shrink Tube

Economic 2:1 tubing is used to insulate terminals after the terminal has been crimped to the wire. Tubing remains flexible and will shrink to approximately 50% of its original size when 160°C (320°F) of heat is applied.

spools

part no.	color	nominal size	spool length	inside diameter after recovery	wire gauge
981525	red	3/16"	1,000'	.093"	16-14
981535	white	1/4"	500'	.125"	12-10
981545	black	3/8"	250'	.187"	8-6
981565	black	1/2"	250'	.250"	4-2
981575	black	3/4"	250'	.375"	8-6
981585	black	1"	100'	.500"	2-1/0



Single Wall Polyolefin 2:1 Shrink Tube – Flexible

2:1 tubing is a very flexible, flame retardant, heat-shrinkable polyolefin tubing. Meets all the requirements of military/specification MIL-1-23053/5 class 1 and class 3. Shrink temperature is 100°C (212°F) with an indefinite storage life. Operating temperature range is -55°C to 125°C (-67°F to 257°F) and up to 200°C (392°F) for a short time.

4-ft sticks

color		nominal size	inside diameter as supplied minimum	inside diameter after recovery maximum	wall thickness after recovery nominal
red	black				
98031501	98031505	1/8"	.125"	.062"	.020"
98030501	98030505	3/16"	.187"	.093"	.020"
98032501	98032505	1/4"	.250"	.125"	.025"
98029501	98029505	3/8"	.375"	.187"	.025"
98033501	98033505	1/2"	.500"	.250"	.025"
98034501	98034505	3/4"	.750"	.375"	.035"
98035501	98035505	1"	1.000"	.500"	.039"
98036501	98036505	1 1/2"	1.500"	.750"	.039"



Place appropriate style and size shrink tube just past area to be sealed.



Make necessary connections and pull shrink tube over area to be sealed.

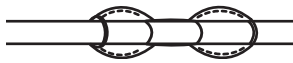

Apply heat from an approved heat source approximately 6" from shrink tube in a 360° fashion until shrink tube is tightly condensed.

spools

color		spool length	nominal size	inside diameter as supplied minimum	inside diameter after recovery maximum	wall thickness after recovery nominal
red	black					
98051501	98051505	500'	1/8"	.125"	.062"	.020"
98050501	98050505	500'	3/16"	.187"	.093"	.020"
98052501	98052505	250'	1/4"	.250"	.125"	.025"
98059501	98059505	200'	3/8"	.375"	.187"	.025"
98053501	98053505	150'	1/2"	.500"	.250"	.025"
98054501	98054505	250'	3/4"	.750"	.375"	.035"
98055501	98055505	250'	1"	1.000"	.500"	.039"
98056501	98056505	125'	1 1/2"	1.500"	.750"	.039"

shrink tube & tape



Scan for pricing or go to www.delcity.net/catalogpricing



Dual Wall 3:1 Shrink Tube – Adhesive-lined, Semi Rigid

This heat-shrinkable polyolefin tubing is flexible and flame retardant. A thick-wall, modified polyimide adhesive melts and flows, encapsulating and sealing components contained within the shrink tube. 3 to 1 tubing complies with the requirements of MIL-25053/4. Class 3 shrink temperature is 100°C (212°F). Operating temperature range is -45°C to 125°C (-49°F to 257°F).

4-ft sticks

color		nominal size	inside diameter as supplied minimum	inside diameter after recovery maximum	wall thickness after recovery nominal
red	black				
98061501	98061505	1/8"	.125"	.032"	.038"
98062501	98062505	1/4"	.250"	.078"	.047"
98063501	98063505	1/2"	.500"	.157"	.055"
98064501	98064505	3/4"	.750"	.315"	.065"
98065501	98065505	1"	1.000"	.400"	.075"
98066501	98066505	1 1/2"	1.500"	.598"	.083"



Triple Wall 3:1 Shrink Tube – Adhesive-lined, Rigid (Extra Thick)

Triple wall adhesive lined polyolefin tubing will deliver the ultimate protection for battery cables. When heat is applied it will bond permanently to your cable and give it a professional look and professional performance. Operating temperature: -55°C to 110°C (-67°F to 230°F) and shrink temperature: 120°C (248°F).

6-in pieces

color		wire gauge	inside diameter as supplied minimum	inside diameter after recovery maximum
red	black			
980715	980725	8 to 1	.748"	.197"
980735	980745	2 to 4/0	1.1"	.236"

4-ft sticks

color		wire gauge	inside diameter as supplied minimum	inside diameter after recovery maximum
red	black			
980815	980825	8 to 1	.748"	.197"
980835	980845	2 to 4/0	1.1"	.236"



Clear 3:1 Shrink Tube – Adhesive-lined, Semi Rigid

This heat-shrinkable polyolefin tubing is flexible and flame retardant. A thick-wall, modified polyimide adhesive internally melts and flows, encapsulating and sealing components contained within the shrink tube. This 3:1 tubing complies with the requirements of MIL-25053/4. Shrink temperature is 110°C (230°F). Operating temperature range is -45°C to 125°C (-49°F to 257°F). Initially cloudy; turns clear when heat is applied, and allows for easy viewing of connected area.

4-ft sticks

part no.	nominal size	inside diameter as supplied	inside diameter after recovery
980600	1/8"	.125"	.032"
980610	3/16"	.188"	.055"
980620	1/4"	.250"	.078"
980630	3/8"	.354"	.118"
980640	1/2"	.500"	.157"
980650	3/4"	.750"	.315"
980660	1"	1.000"	.400"
980670	1 1/2"	1.500"	.568"

shrink tube & tape

Translucent Dual Wall 3:1 Shrink Tube – Adhesive-lined, Semi Rigid ^{UL} ^{CS} ^{US}

Adhesive-lined polyolefin shrinks 3:1 of its original size as supplied and is imprinted and color-coded to industry standard for gauge size. Operating temperature: -55°C to 110°C (-67°F to 230°F) and shrink temperature: 135°C (275°F). UL listed and meets MIL-DTL-23053/4.



Scan for pricing or go to www.delcity.net/catalogpricing



6-in pieces

part no.	color	pkg. qty.	gauge size	inside diameter as supplied minimum	inside diameter after recovery maximum	wall thickness after recovery nominal
980415	red	10	20–18	.215"	.045"	.060"
980425	blue	10	16–14	.255"	.080"	.060"
980435	yellow	10	12–10	.305"	.100"	.060"

4-ft sticks

part no.	color	pkg. qty.	gauge size	inside diameter as supplied minimum	inside diameter after recovery maximum	wall thickness after recovery nominal
98041548	red	1 min	20–18	.215"	.045"	.060"
98042548	blue	1 min	16–14	.255"	.080"	.060"
98043548	yellow	1 min	12–10	.305"	.100"	.060"

Dual Wall 4:1 Shrink Tube – Adhesive-lined, Rigid

Adhesive-lined shrink tubing provides the best protection for electrical connections. This tubing shrinks down 28% more than standard 3:1 shrink tubing and features a free flowing adhesive that is ideal for protecting multiple wires and irregular shapes from harsh environments. Remaining flexible after installation, this tubing is perfect for wire harnesses and trailer applications. The clear feature also allows for visual inspection after installation. Each piece is marked with a dash-colored line coded to the inside diameter size. Rated to -55°C to 110°C (-67°F to 230°F).

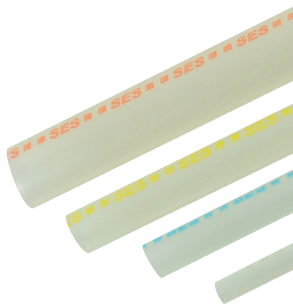

6-in pieces

part no.	color	pkg. qty.	gauge size	inside diameter as supplied minimum	inside diameter after recovery maximum	wall thickness after recovery nominal
985400	clr/white	10	24–12	.220"	.045"	.060"
985405	clr/blue	10	16–8	.350"	.080"	.060"
985410	clr/yell	10	14–4	.450"	.018"	.090"
985415	clr/org	10	8–2/0	.700"	.105"	.110"

Clear-View™ Dual Wall 2.5:1 Shrink Tubing – Adhesive-lined, Semi Rigid

Clear-View™ is a crystal clear special cross-linked ionic polymer that provides optimal clarity for visual inspection even after it has been heated to its fully recovered state. The tubing provides a waterproof seal and has wire gauge imprinted to help identify size. Specifications include: 4,000 psi tensile strength, FMVSS302 flammability testing and dielectric strength of 750 V/Mil (30KV/MM). Operating temperature of -55°C to 125°C (-67°F to 257°F) and recovery temperature of 90°C (194°F).

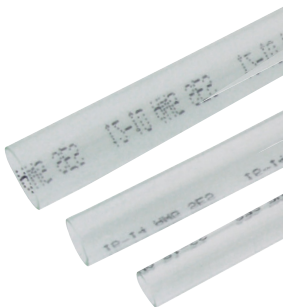

6-in pieces

part no.	color	pkg. qty.	gauge size	inside diameter as supplied minimum	inside diameter after recovery maximum
984115	clear	10	24–18	.176"	.045"
984125	clear	10	16–14	.250"	.080"
984135	clear	10	12–10	.365"	.100"

Single Wall 2:1 Shrink Tube Kit – HS 455™

Sealing and securing can now be taken to go! This kit contains 55 6" pieces of 2:1 single wall polyolefin, flexible type, I.D. ranges 1/8"–1/2" in red, black, yellow and blue. The shrink tube is UL listed and meets MIL-1-23053/5. Excellent for securing and insulating almost any wire connection. All contained within a durable, lightweight, translucent carrying case (7" x 3" x 1-1/2"). **For a complete listing of kit contents, see page 327.**



part no.	description	pieces
553	HS 455™ 2:1 shrink tube kit	55

shrink tube & tape



Scan for pricing or go to www.delcity.net/catalogpricing



Single Wall 2:1 Shrink Tube Kit – *The Protector™*

Perfect for insulating all of your wire connecting jobs. This kit contains 6" length shrink tube pieces. I.D. ranges 1/8"-3/4" in black, red, blue and yellow. Flame retardant 2:1 single wall 2-1 polyolefin shrink tube, flexible type. UL listed and meets MIL-1-23053/5. All contained within a durable, lightweight, translucent carrying case (11" x 6-3/4" x 1-3/4").

For a complete listing of kit contents, see page 327.

part no.	description	pieces
550	Protector™ 2:1 shrink tube kit	105



Dual Wall 3:1 Shrink Tube Kit – *Over-Armor™*

This kit is a bit smaller than it's big brother The Brute™ shrink tube kit. It contains 30 pieces of 3:1 dual wall polyolefin shrink tube, semi rigid type, I.D. ranges from 1/8" to 1/2" in both black and red. UL listed and meets MIL-DTL-23053/4. All contained within a durable, lightweight, translucent carrying case (7" x 3" x 1-1/2").

For a complete listing of kit contents, see page 327.

part no.	description	pieces
554	Over-Armor™ 3:1 shrink tube kit	30



Dual Wall 3:1 Shrink Tube Kit – *The Brute™*

The Brute™ contains sixty-six pieces of 10 different sizes of adhesive-lined polyolefin shrink tube in black and red, 6" cut lengths I.D. range for 1/8"-1" as supplied. 3:1 dual wall polyolefin, semi rigid type. UL listed and meets MIL-DTL-23053/4. This shrink tube is flame retardant and self-sealing. All contained within a durable, lightweight, translucent carrying case (11" x 6-3/4" x 1-3/4").

For a complete listing of kit contents, see page 327.

part no.	description	pieces
551	Brute™ 3:1 shrink tube kit	66



Translucent Dual Wall 3:1 Shrink Tube Kit – *The Professional™*

The perfect match for post installation inspection of underlying components. This kit contains eighty-three total pieces of 10 different sized adhesive-lined 3:1 dual wall polyolefin shrink tube, semi rigid type; in clear, red, blue and yellow; 6" cut lengths I.D. range from 1/8"-3/4". The shrink tube kit is UL listed and meets MIL-DTL-23053/4, Class 1; AMS3534 (excluding clear shrink tube). The gauge size is imprinted on the translucent, color-coded shrink tube. All contained within a durable, lightweight, translucent carrying case (11" x 6-3/4" x 1-3/4").

For a complete listing of kit contents, see page 327.

part no.	description	pieces
552	Professional™ 3:1 shrink tube kit	83



Shrink Tube Assortment Kit – *The Bully™*

This kit includes single wall 6" lengths of 2:1 shrink tube in 1/8", 3/16", 1/4" & 3/8" in red, blue, black and yellow; 3:1 dual wall 6" lengths of semi-rigid heat shrink in 1/4", 3/8", 1/2" & 3/4" in black and clear; 3:1 dual wall 6" lengths of semi-rigid shrink tube in 20-18, 16-14 & 12-10 gauge (industry standard colored) translucent tubes and 3:1 triple wall 6" lengths of semi-rigid shrink tube in 8 to 1 AWG and 2 to 4/0 in black and red. All are packaged within a gray metal scoop box (18" x 12" x 3").

For a complete listing of kit contents, see page 328.

part no.	description	pieces
555	Bully™ shrink tube assortment kit	176



3M™ Multi-Purpose Duct Tape (5.77 MIL)

This tape is ideal for light-duty marking and non-critical applications. The polyethylene backing provides moisture resistance and the synthetic rubber adhesive allows for adhesion to many different surfaces. The 5.7mm thickness provides a lower profile for tight areas. It has a temperature rating of 93°C (200°F) and tensile strength of 16 lbs. The 1.88-in (48mm) x 150-ft (45.7m) length provides enough tape to finish almost any job.

part no.	size	description	color
350	1.88" x 150'	standard duct tape	silver



Scan for pricing or go to www.delcity.net/catalogpricing

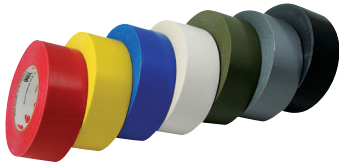

3M™ Heavy-duty Multi-Purpose Duct Tape (7.7 MIL)

This versatile duct tape is ideal for general maintenance, wrapping, sealing, protecting and color-coding. The polyethylene film over the cloth scrim and rubber adhesive provides a moisture resistant seal. The 7.7mm thickness provides abrasion resistance and is ideal for being applied to irregular shapes and sizes. It has a temperature rating of 93°C (200°F) and tensile strength of 22 lbs. This 1.88-in (48mm) x 180-ft (54.8m) duct tape is available in 7 different colors.

part no.	size	description	color
360	1.88" x 180'	multi-purpose duct tape	black
361DL	1.88" x 180'	multi-purpose duct tape	olive
362	1.88" x 180'	multi-purpose duct tape	blue
363	1.88" x 180'	multi-purpose duct tape	silver
364	1.88" x 180'	multi-purpose duct tape	red
365	1.88" x 180'	multi-purpose duct tape	white
366	1.88" x 180'	multi-purpose duct tape	yellow



3M™ Extra Heavy-Duty Duct Tape (10.7 MIL)

This rugged duct tape is designed for the most demanding applications in the automotive, trucking, construction, industrial and HVAC markets. The polyethylene film covers the dense cloth scrim, providing abrasion resistance and waterproof backing. The rubber adhesive securely attaches to most material and irregular shapes and sizes. This 10.7mm thick duct tape provides ample protection for almost any job. Meets UL 723, HUD and BOCA codes. It has a temperature rating of 93°C (200°F) and tensile strength of 35 lbs. This 1.88-in (48mm) x 180-ft (54.8m) duct tape is available in 3 different colors.

part no.	size	description	color
370	1.88" x 180'	extra heavy-duty duct tape	black
371	1.88" x 180'	extra heavy-duty duct tape	olive
372	1.88" x 180'	extra heavy-duty duct tape	silver



Liquid Tape

A liquid coating used to insulate and protect electrical splices and connections. The waterproof coating will not unravel or deteriorate like tape. The 4 oz. container includes a brush-on applicator. Usable temperature range: -34°C to 93°C - 30°F to 200°F.

part no.	size	description	color
330DL	4 oz.	liquid tape	black
331DL	4 oz.	liquid tape	red
19015168	4 oz.	liquid tape	white
19015167	4 oz.	spray tape	black

shrink tube & tape



Scan for pricing or go to www.delcity.net/catalogpricing



Vinyl Electrical Tape (7 MIL)

This vinyl electrical tape is a tough 7 mil tape with excellent adhesive ability. UL rated, control no. 362K. Temperature rating: 80°C (176°F).

part no.	size	description	color
733	¾" x 60'	single roll	black
7335	¾" x 60'	case – 100 rolls	black



3M Scotch™ Super 88 (8.5 MIL)

This vinyl electrical tape is particularly suited for cold weather applications. It provides primary electrical insulation for all wire and cable splices rated up to 600 volts. Resistant to weather, UV rays, abrasion, corrosion, alkalis and acids, it provides a protective jacketing for high voltage cables splices and repairs. Meets requirements of ASTM D-3005, Type II, UL 510 and MIL-1-24391. Temperature range: -18°C to 105°C (0°F to 221°F).

part no.	size	description	color
883	¾" x 66'	single roll	black
8835	¾" x 66'	case – 100 rolls	black



3M Scotch™ Super 33+ (7 MIL)

This vinyl electrical tape provides primary electrical insulation for all wire and cable splices, rated up to 600 volts for fixture and wire splices up to 1000 volts. It can be applied at -18°C (0°F) and has an operating range up to 105°C (220°F). It's flame retardant, resists UV rays, abrasion, moisture, alkalis, acids, hot and cold weather. Meets requirements of ASTM D-3005, Type I, UL 510, HHI-595C and CSA 22.2.

part no.	size	description	color
335	¾" x 66'	single roll	black
3335	¾" x 66'	case – 100 rolls	black



3M Scotch™ (30 MIL) Linerless Electrical Rubber Tape

This Scotch™ 2242 tape is an economical general purpose rubber insulating tape, well suited for small terminating and splicing jobs. It seals and insulates to resist moisture and other harsh conditions, and is flame retardant.

part no.	size	description	color
633	¾" x 15'	single roll	black
6335	¾" x 15'	case – 24 rolls	black

Use With

shrink tube

PAGES 41-44



Amalgamating (Cold Shrink) Tape

This tape was originally developed for power and distribution cables but it can be used for bundling, underground wiring, repairing hoses, pipe leaks, etc. Excellent for moisture sealing in electrical installations, industrial and marine applications. Ideal for covering cable lugs, splices and termination.

INFORMATION

When the tape is applied with a high degree of stretch (2 to 3 times for stretch) within two to three minutes, it has already begun to amalgamate. Within four hours, it will be a solid mass of rubber. NOTE: The tape is NOT resistant to hydrocarbon type solvents, oils and greases.

part no.	size	thickness (nom. mm)	description	color
734	1" x 30'	7	single roll	black



Scan for pricing or go to www.delcity.net/catalogpricing



Splice and Joint Tape Sealant

Soft, tacky and pliable material having the ability to seal with a wide variety of substrates including: rubbers, plastics and metals, while remaining flexible for extended periods of time. Operating temperature range is -40°C to 90°C (-40°F to 194°F). Curing temperature is 110°C (230°F). Resistant to alcohol, ketone, acids and alkalis.

part no.	size	thickness (nom. in)	description	color
736	1" x 25'	1/16"	single roll	grey

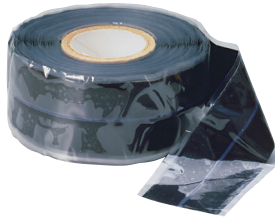

Wrap N Seal™ Self-fusing Silicone Tape

This tape self-fuses without heat, forming a solid rubber insulation in 24 hours. It has a high dielectric strength, wide operating temperature and is easy to apply. Use this tape to insulate and protect harnesses, splices, motor leads, etc.

part no.	size	thickness (nom. in)	description	color
233	1" x 20'	1/16"	single roll	red
235	1" x 20'	1/16"	single roll	black



Electrical Tape

Quality electrical tape is designed for general purpose electrical applications. Made from low-lead PVC material, it is designed for use in applications up to 600 volts and temperatures up to 80°C (176°F). This tape is also resistant to abrasion, UV rays, moisture, alkalis, solvents and many acids. Each roll is individually packaged in cello wrap.

part no.	size	thickness (nom. mm)	description	color
2241DL	¾" x 66'	7	single roll	red
2242	¾" x 66'	7	single roll	white
2243DL	¾" x 66'	7	single roll	blue
2244DL	¾" x 66'	7	single roll	green

Assorted Colors Electrical Tape

Quality electrical tape designed for general purpose electrical applications. Manufactured from low-lead PVC material, it is designed for use in applications up to 600V and temperature up to 80°C (176°F). It is also resistant to abrasions, UV rays, moisture, alkalis, solvents and many acids. Pack includes the following colors: White, Red, Blue, Green and Yellow.



part no.	size	thickness (nom. mm)	description	color
19015160	1/2" x 20'	7	five rolls	white, red, blue, green, yellow



The FixIt™ Electrical Repair Kit – Twin Kit™ Series

This kit offers quick, convenient, high-quality products in one handy case. It's packed with fuses, terminals, shrink tube, wire and wire splices, wire nuts, cable ties and grommets. Also included: steel cleaning brush, battery and alternator tester, crimp tool and screwdrivers. All contained within a durable, lightweight, carrying case (10-3/4" x 7-1/2" x 3-1/4").

For a complete listing of kit contents, see page 336.

part no.	description	pieces
410DL	FixIt™ electrical repair kit	210

clamps & grommets

Standard Hose Clamps

A full line of hose clamps is headed up by this standard multi-purpose clamp. Versatile enough to be used in a number of general clamping applications. The stainless steel band and housing resists corrosion. 2363DL and 2364DL, meet SAE standard J1508 Type M. All other clamps 2365DL-2379, meet SAE standard J1508 Type F.

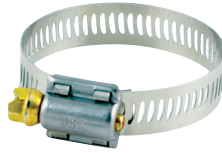

Specifications

band:

micro: 5/16" stainless steel
(2363DL & 2364DL)
standard: 1/2" stainless steel
(2365DL through 2379)

housing:

stainless steel

screw:

micro: 1/4" hex head – carbon steel (2363DL & 2364DL)
standard: 5/16" hex head – carbon steel
(2365DL through 2379)

part no.	diameter range	SAE size	lbs per 100 pcs.	part no.	diameter range	SAE size	lbs per 100 pcs.
2363DL	7/32"–5/8"	004	2	2372	1 5/16"–2 1/4"	028	6
2364DL	7/16"–25/32"	006	2	2373	1 9/16"–2 1/2"	032	7
2365DL	7/16"–25/32"	006	4	2374DL	1 13/16"–2 3/4"	036	7
2366	1/2"–29/32"	008	4	2375	2 1/16"–3"	040	8
2367	9/16"–1 1/16"	010	4	2376	2 5/16"–3 1/4"	044	8
2368DL	1 1/16"–1 1/4"	012	5	2377DL	2 9/16"–3 1/2"	048	8
2369DL	1 3/16"–1 1/2"	016	5	2378DL	2 13/16"–3 3/4"	052	8
2370DL	1 3/16"–1 3/4"	020	5	2379	3 1/16"–4"	056	10
2371DL	1 1/16"–2"	024	6				

pkg qty: 10



Specifications

band:

micro: 5/16" stainless steel
(236302 & 236402)
standard: 1/2" stainless steel
(236502 through 237902)

housing:

stainless steel

screw:

micro: 1/4" hex head – stainless steel (236302 & 236402)
standard: 5/16" hex head – stainless steel
(236502 through 237902)

Stainless Steel Hose Clamps

Total stainless steel construction makes these clamps extra tough and durable. Ideal for use in corrosive environments and applications such as plumbing, sprinkler systems, swimming pools, automotive, marine and agricultural environments. 236302 and 236402 meet SAE standard J1508 Type M. 236502 - 237902 meet SAE standard J1508 Type F.

part no.	diameter range	SAE size	lbs per 100 pcs.	part no.	diameter range	SAE size	lbs per 100 pcs.
236302	7/32"–5/8"	004	2	237202	1 5/16"–2 1/4"	028	6
236402	7/16"–25/32"	006	2	237302	1 9/16"–2 1/2"	032	6
236502	7/16"–25/32"	006	3	237402	1 13/16"–2 3/4"	036	6
236602	1/2"–29/32"	008	4	237502	2 1/16"–3"	040	7
236702	9/16"–1 1/16"	010	4	237602	2 5/16"–3 1/4"	044	7
236802	1 1/16"–1 1/4"	012	5	237702	2 9/16"–3 1/2"	048	7
236902	1 3/16"–1 1/2"	016	5	237802	2 13/16"–3 3/4"	052	8
237002	1 3/16"–1 3/4"	020	5	237902	3 1/16"–4"	056	8
237102	1 1/16"–2"	024	5				

pkg qty: 10



Specifications

band:

1/2" stainless steel

housing:

stainless steel

screw:

5/16" hex head – carbon steel

Shielded Hose Clamps

Designed for use on silicone and other soft hose material. Features an inner stainless steel band to prevent material from protruding through the notches in the outer band. One-piece inner liner is double welded preventing separation. All Clamps meet SAE standard J1508 Type F.

part no.	diameter range	SAE size	lbs per 100 pcs.	part no.	diameter range	SAE size	lbs per 100 pcs.
236504	7/16"–25/32"	006	5	237004	1 3/16"–1 3/4"	020	6
236604	1/2"–29/32"	008	5	237104	1 1/16"–2"	024	7
236704	9/16"–1 1/16"	010	6	237204	1 5/16"–2 1/4"	028	7
236804	1 1/16"–1 1/4"	012	6	237304	1 9/16"–2 1/2"	032	8
236904	1 3/16"–1 1/2"	016	6				

pkg qty: 10



Scan for pricing or go to www.delcity.net/catalogpricing

clamps & grommets



Specifications

band:
3/16" stainless steel

housing:
stainless steel

screw:
standard: 5/16" hex head

hex head:
stainless steel

Constant Torque Clamps

Provides automatic adjustments for constant torque on expanding and contracting hoses. The housing is riveted to the saddle at four points providing added strength. The shield protects soft hoses from damage and helps to maintain consistent sealing pressure. Torque rated to 40–70 in/lbs. All clamps meet SAE standard J1508 Type SLHD.

part no.	diameter range	SAE size
2200	9/16"–1 1/16"	10
2202DL	1 1/16"–1 1/4"	12
2204DL	1 3/16"–1 1/2"	16
2206DL	1 3/16"–1 3/4"	20
2208DL	1 1/16"–2"	24
2212DL	1 9/16"–2 1/2"	32
2214DL	1 13/16"–2 3/4"	36
2216DL	2 1/16"–3"	40
2218DL	2 5/16"–3 1/4"	44
2222DL	2 9/16"–3 1/2"	48

pkg qty: 1

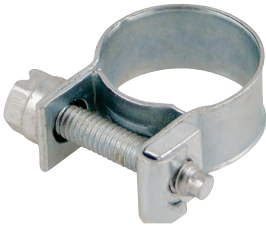

Fuel Injection Hose Clamps

Designed with a non-perforated band of aluzinc-coated carbon. The screw is also zinc-plated carbon. The nut is steel.

part no.	diameter range	lbs per 100 pcs
210402	7/16"–1/2"	2
210602	1/2"–9/16"	3
210802	9/16"–5/8"	4

pkg qty: 10



Muffler Clamps

Muffler clamps are perfect for most exhaust applications. Each clamp is made up of an 11-gauge saddle, 3/8" diameter U-bolt and two serrated nuts that provide secure exhaust connections. Clamps are made from 14ga mild steel and are available in sizes ranging from 1-3/4" up to 5" clamping diameter.

part no.	description	diameter range
12200134	muffler clamps, heavy-duty U-bolts	1 3/4"
12200178	muffler clamps, heavy-duty U-bolts	1 7/8"
12200200	muffler clamps, heavy-duty U-bolts	2"
12200214	muffler clamps, heavy-duty U-bolts	2 1/4"
12200212	muffler clamps, heavy-duty U-bolts	2 1/2"
12200234	muffler clamps, heavy-duty U-bolts	2 3/4"
12200300	muffler clamps, heavy-duty U-bolts	3"
12200312	muffler clamps, heavy-duty U-bolts	3 1/2"
12200400	muffler clamps, heavy-duty U-bolts	4"
12200500	muffler clamps, heavy-duty U-bolts	5"

pkg qty: 1



12201105



12201109

Exhaust Hangers

Exhaust hangers are ideal for use in repairing and replacing existing rusted or worn out exhaust hangers. They are manufactured from high-strength steel and are designed to work with various sized pipes and U-bolt clamps. Hangers can be cut, bent or modified to fit most applications.

part no.	description
12201100	"swivel" hanger H.D. 360 design
12201105	universal hanger for 1 1/2" - 2 1/2" pipes
12201109	universal strap hanger
12201200	swivel tail pipe hanger

pkg qty: 1



Scan for pricing or go to www.delcity.net/catalogpricing

clamps & grommets

Cable Clamps

Plated steel, stainless steel and aluminum clamps have a removable EPDM cushion to help reduce vibration while protecting the loom or cables. Typical applications include holding hydraulic hoses, wire harnesses and cables. The mounting hole is $\frac{1}{4}$ " for $\frac{1}{4}$ " screws or bolts.

zinc plated SPCC-5D steel clamps (EPDM removable jacket)

part no.	size closed I.D.	bundle lines O.D.		SAE size	part no.	size closed I.D.	bundle lines O.D.		SAE size
		min.	max.				min.	max.	
2004*	$\frac{1}{4}$ "	$\frac{3}{16}$ "	$\frac{1}{4}$ "	004	2024	$1\frac{1}{2}$ "	$1\frac{3}{8}$ "	$1\frac{1}{2}$ "	024
2006*	$\frac{3}{8}$ "	$\frac{1}{4}$ "	$\frac{5}{8}$ "	006	2026	$1\frac{5}{8}$ "	$1\frac{1}{2}$ "	$1\frac{5}{8}$ "	026
2008*	$\frac{1}{2}$ "	$\frac{3}{8}$ "	$\frac{1}{2}$ "	008	2028	$1\frac{3}{4}$ "	$1\frac{5}{8}$ "	$1\frac{3}{4}$ "	028
2010*	$\frac{5}{8}$ "	$\frac{1}{2}$ "	$\frac{5}{8}$ "	010	2030	$1\frac{7}{8}$ "	$1\frac{3}{4}$ "	$1\frac{7}{8}$ "	030
2012*	$\frac{3}{4}$ "	$\frac{5}{8}$ "	$\frac{3}{4}$ "	012	2032	2"	$1\frac{7}{8}$ "	2"	032
2014*	$\frac{7}{8}$ "	$\frac{3}{4}$ "	$\frac{7}{8}$ "	014	2034	$2\frac{1}{8}$ "	2"	$2\frac{1}{8}$ "	034
2016*	1"	$\frac{7}{8}$ "	1"	016	2036	$2\frac{1}{4}$ "	$2\frac{1}{8}$ "	$2\frac{1}{4}$ "	036
2018	$1\frac{1}{8}$ "	1"	$1\frac{1}{8}$ "	018	2038	$2\frac{3}{8}$ "	$2\frac{1}{4}$ "	$2\frac{3}{8}$ "	038
2020	$1\frac{1}{4}$ "	$1\frac{1}{8}$ "	$1\frac{1}{4}$ "	020	2040	$2\frac{1}{2}$ "	$2\frac{3}{8}$ "	$2\frac{1}{2}$ "	040
2022	$1\frac{3}{8}$ "	$1\frac{1}{4}$ "	$1\frac{3}{8}$ "	022	2048	3"	$2\frac{7}{8}$ "	3"	048

* pkg qty: 100; all others pkg qty: 10

SUS304 stainless steel clamps (EPDM removable jacket)

part no.	size closed I.D.	bundle lines O.D.		SAE size	part no.	size closed I.D.	bundle lines O.D.		SAE size
		min.	max.				min.	max.	
200409	$\frac{1}{4}$ "	$\frac{3}{16}$ "	$\frac{1}{4}$ "	004	202209	$1\frac{3}{8}$ "	$1\frac{1}{4}$ "	$1\frac{3}{8}$ "	022
200609	$\frac{3}{8}$ "	$\frac{1}{4}$ "	$\frac{3}{8}$ "	006	202409	$1\frac{1}{2}$ "	$1\frac{3}{8}$ "	$1\frac{1}{2}$ "	024
200809	$\frac{1}{2}$ "	$\frac{3}{8}$ "	$\frac{1}{2}$ "	008	202609	$1\frac{5}{8}$ "	$1\frac{1}{2}$ "	$1\frac{5}{8}$ "	026
201009	$\frac{5}{8}$ "	$\frac{1}{2}$ "	$\frac{5}{8}$ "	010	202809	$1\frac{3}{4}$ "	$1\frac{5}{8}$ "	$1\frac{3}{4}$ "	028
201209	$\frac{3}{4}$ "	$\frac{5}{8}$ "	$\frac{3}{4}$ "	012	203009	$1\frac{7}{8}$ "	$1\frac{3}{4}$ "	$1\frac{7}{8}$ "	030
201409	$\frac{7}{8}$ "	$\frac{3}{4}$ "	$\frac{7}{8}$ "	014	203209	2"	$1\frac{7}{8}$ "	2"	032
201609	1"	$\frac{7}{8}$ "	1"	016	204009	$2\frac{1}{2}$ "	$2\frac{3}{8}$ "	$2\frac{1}{2}$ "	040
201809	$1\frac{1}{8}$ "	1"	$1\frac{1}{8}$ "	018	204809	3"	$2\frac{7}{8}$ "	3"	048
202009	$1\frac{1}{4}$ "	$1\frac{1}{8}$ "	$1\frac{1}{4}$ "	020					

pkg qty: 10

5052 aluminum clamps (EPDM removable jacket)

part no.	size closed I.D.	bundle lines O.D.		SAE size	part no.	size closed I.D.	bundle lines O.D.		SAE size
		min.	max.				min.	max.	
2804*	$\frac{1}{4}$ "	$\frac{3}{16}$ "	$\frac{1}{4}$ "	004	2816*	1"	$\frac{7}{8}$ "	1"	016
2806*	$\frac{3}{8}$ "	$\frac{1}{4}$ "	$\frac{3}{8}$ "	006	2820	$1\frac{1}{4}$ "	$1\frac{1}{8}$ "	$1\frac{1}{4}$ "	020
2808*	$\frac{1}{2}$ "	$\frac{3}{8}$ "	$\frac{1}{2}$ "	008	2824	$1\frac{1}{2}$ "	$1\frac{3}{8}$ "	$1\frac{1}{2}$ "	024
2810*	$\frac{5}{8}$ "	$\frac{1}{2}$ "	$\frac{5}{8}$ "	010	2832	2"	$1\frac{7}{8}$ "	2"	032
2812*	$\frac{3}{4}$ "	$\frac{5}{8}$ "	$\frac{3}{4}$ "	012	2840	$2\frac{1}{2}$ "	$2\frac{3}{8}$ "	$2\frac{1}{2}$ "	040
2814*	$\frac{7}{8}$ "	$\frac{3}{4}$ "	$\frac{7}{8}$ "	014					

* pkg qty: 100; all others pkg qty: 10

vinyl-coated SPCC-5D steel clamps

part no.	size closed I.D.	bundle lines O.D.		SAE size	part no.	size closed I.D.	bundle lines O.D.		SAE size
		min.	max.				min.	max.	
2904*	$\frac{1}{4}$ "	$\frac{3}{16}$ "	$\frac{1}{4}$ "	004	2916*	1"	$\frac{7}{8}$ "	1"	016
2906*	$\frac{3}{8}$ "	$\frac{1}{4}$ "	$\frac{3}{8}$ "	006	2920	$1\frac{1}{4}$ "	$1\frac{1}{8}$ "	$1\frac{1}{4}$ "	020
2908*	$\frac{1}{2}$ "	$\frac{3}{8}$ "	$\frac{1}{2}$ "	008	2924	$1\frac{1}{2}$ "	$1\frac{3}{8}$ "	$1\frac{1}{2}$ "	024
2910*	$\frac{5}{8}$ "	$\frac{1}{2}$ "	$\frac{5}{8}$ "	010	2932	2"	$1\frac{7}{8}$ "	2"	032
2912*	$\frac{3}{4}$ "	$\frac{5}{8}$ "	$\frac{3}{4}$ "	012	2940	$2\frac{1}{2}$ "	$2\frac{3}{8}$ "	$2\frac{1}{2}$ "	040
2914*	$\frac{7}{8}$ "	$\frac{3}{4}$ "	$\frac{7}{8}$ "	014					

* pkg qty: 100; all others pkg qty: 10



Scan for pricing or go to www.delcity.net/catalogpricing



clamps & grommets

Carbon Steel Plated Cable Clamps

Carbon steel plated loom clamps with zinc/gold chromate have a removable EPDM jacket. Mounting hole is .406" with 3/8" stud. Width of steel is 3/8". Carbon steel has a higher ductility and is susceptible to less fatigue.



part no.	size closed I.D.	mounting lines O.D.		SAE size	part no.	size closed I.D.	mounting lines O.D.		SAE size
		min.	max.				min.	max.	
200403	1/4"	3/16"	1/4"	004	202003	1 1/4"	1 1/8"	1 1/4"	020
200603	3/8"	1/4"	5/8"	006	202203	1 3/8"	1 1/4"	1 3/8"	022
200803	1/2"	3/8"	1/2"	008	202403	1 1/2"	1 3/8"	1 1/2"	024
201003	5/8"	1/2"	5/8"	010	202603	1 5/8"	1 1/2"	1 5/8"	026
201203	3/4"	5/8"	3/4"	012	202803	1 3/4"	1 5/8"	1 3/4"	028
201403	7/8"	3/4"	7/8"	014	203003	1 7/8"	1 3/4"	1 7/8"	030
201603	1"	7/8"	1"	016	203203	2"	1 7/8"	2"	032
201803	1 1/8"	1"	1 1/8"	018					

pkg qty: 10



Scan for pricing or go to www.delcity.net/catalogpricing

Nylon Cable Clamps

These nylon 6/6 clamps are tough, resilient, lightweight, resistant to aging and most chemicals. Mounting hole is 13/64" diameter. Meets UL flammability classification UL94V-2. Recognized under the Component Program of Underwriters Laboratories Inc.



natural nylon

part no.	size closed I.D.	pkg qty.	part no.	size closed I.D.	pkg qty.
2402	1/8"	100	2410	5/8"	100
2403	3/16"	100	2412	3/4"	100
2404	1/4"	100	2416	1"	100
2406	3/8"	100	2424	1 1/2"	100
2408	1/2"	100			

black

part no.	size closed I.D.	pkg qty.	part no.	size closed I.D.	pkg qty.
2503DL	3/16"	100	2510	5/8"	100
2504DL	1/4"	100	2512	3/4"	100
2506	3/8"	100	2516	1"	100
2508	1/2"	100	2524	1 1/2"	100

pkg qty: 100

Mechanics Wire

Mechanics wire is a 19-gauge soft annealed steel wire that can be easily bent, molded or configured and is designed for use in emergency or temporary-fix situations. It is most commonly used for repairing a broken clamp, fastener or other general automotive quick fix applications. Available in 50' spools, having mechanics wire in your trunk may help you get home.



part no.	description	reel size
12202200	mechanics wire	50'

Cable Wraptor™

Provide an ideal solution for all of your cord or cable bundling applications. The "T" handle with mounting hole provides a comfortable carrying grip and easily hangs for storage. The large and evenly spaced teeth design ensures a strong and secure locking system. It is manufactured from durable impact resistant plastic with stainless steel hinge pin.

For a complete list of kit components, see page 331.



part no.	description	clamp diameter	max load*
989599	mini	1"	25 lbs
989600	medium	2"	50 lbs
989602	large	3"	100 lbs
989604	x-large	4"	150 lbs
989605	kit	1" - 4"	25 - 150 lbs

*Max load shown is for reference only. Actual sustainable load varies based on application.



clamps & grommets

Rubber Grommets

Protect wires from chafing against drilled holes with rubber grommets. Grommets are organized by groove width in the chart below. Select specific groove width and locate other pertinent dimensions provided in the chart. **PLEASE NOTE: Groove diameter is the size of hole needed to snap a grommet into for the best fit.** Material is styrene butadiene rubber (SBR) and is black in color.



Scan for pricing or go to www.delcity.net/catalogpricing

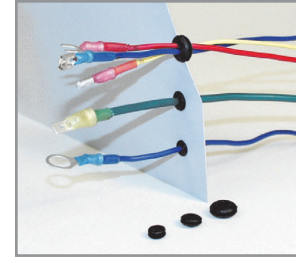
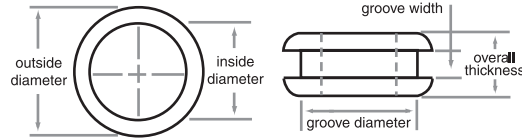

1/16" groove width

part no.	inside dia.	groove dia.	outside dia.	overall thickness
5102DL	1/8"	1/4"	11/32"	3/16"
5104	3/16"	5/16"	7/16"	3/16"
5106	1/4"	3/8"	9/16"	1/4"
5108	5/16"	7/16"	9/16"	3/16"
5110	5/16"	9/16"	13/16"	5/16"
5112	3/8"	1/2"	5/8"	1/4"
5114	3/8"	5/8"	7/8"	5/16"
5116	7/16"	9/16"	3/4"	1/4"
5118	7/16"	11/16"	15/16"	5/16"
5120	1/2"	13/16"	1 1/16"	5/16"
5122	9/16"	13/16"	1 1/16"	5/16"
5124	5/8"	7/8"	1 1/8"	5/16"
5126	3/4"	7/8"	1 1/8"	9/32"
5128	3/4"	1 1/16"	1 3/8"	3/8"
5130	7/8"	1 1/4"	1 5/8"	7/16"
5132	1"	1 3/8"	1 3/4"	7/16"
5134	1 1/2"	1 3/4"	2 1/8"	7/16"
5136	2 1/8"	2 1/2"	2 7/8"	7/16"

1/4" groove width

part no.	inside dia.	groove dia.	outside dia.	overall thickness
5192	3/4"	1 1/16"	1 3/8"	9/16"
5194	1"	1 3/8"	1 3/4"	5/8"
5196	1 1/2"	1 3/4"	2"	1/2"

1/8" groove width

part no.	inside dia.	groove dia.	outside dia.	overall thickness
5150	3/16"	5/16"	7/16"	1/4"
5152	1/4"	3/8"	1/2"	9/32"
5154	3/8"	17/32"	3/4"	1/2"
5156	3/8"	5/8"	7/8"	3/8"
5158	1/2"	3/4"	1"	1/2"
5160	5/8"	7/8"	1 1/8"	3/8"
5162	1 1/16"	1"	1 5/16"	7/16"
5164	3/4"	1 1/16"	1 3/8"	7/16"
5166	7/8"	1 1/4"	1 5/8"	1/2"
5168	1"	1 3/8"	1 3/4"	1/2"
5170	1 1/2"	1 3/4"	2 1/8"	1/2"
5172	2 1/8"	2 1/2"	2 7/8"	7/16"

3/16" groove width

part no.	inside dia.	groove dia.	outside dia.	overall thickness
5180	1/4"	7/16"	5/8"	5/16"
5182	3/8"	5/8"	7/8"	7/16"
5184	1/2"	13/16"	1 1/16"	7/16"
5186	7/8"	1 1/4"	1 5/8"	9/16"
5187	1"	1 3/8"	1 3/4"	9/16"
5188	1 1/2"	1 3/4"	2 1/8"	9/16"

clamps & grommets

Nylon Grommets

Eliminate wire abrasion caused by metal panel cutouts with these nylon 6/6 grommets. Temperature rating up to 105°C (221°F). Insulate and protect electrical and telecommunications cable, tubing, hose, rope and utility lines. Recognized under the component program of Underwriters Laboratories Inc. Flammability rating 94V-2.



Scan for pricing or go to www.delcity.net/catalogpricing

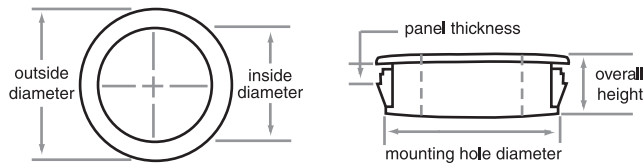

nylon grommets

part no.	mounting hole dia.	inside dia.	outside dia.	overall height	panel thickness
5000*	.187"	1/8"	1/4"	15/64"	1/16"
5002*	.312"	3/16"	3/8"	5/16"	1/16"
5004	.375"	1/4"	15/32"	13/32"	1/8"
5006	.437"	5/16"	17/32"	13/32"	1/8"
5008	.500"	3/8"	37/64"	13/32"	1/8"
5010	.562"	7/16"	21/32"	13/32"	1/8"
5012	.625"	1/2"	23/32"	13/32"	1/8"
5014	.687"	9/16"	25/32"	13/32"	1/8"
5016	.750"	5/8"	27/32"	13/32"	1/8"
5017	.875"	11/16"	61/64"	29/64"	1/8"
5018	1.000"	3/4"	1 1/8"	29/64"	1/8"
5020	1.093"	7/8"	17/32"	29/64"	1/8"
5022	1.375"	1	1 15/32"	29/64"	1/8"

*thickness difference



universal grommets

part no.	mounting hole dia.	inside dia.	outside dia.	overall height	panel thickness
5024	.750"	1/2"	55/64"	25/64"	1/8"



Flexible Grommeting

This flexible grommeting protects and insulates wires and cables from chafing against sharp chassis edges. The serrated design is ideal for irregular shaped panel holes. Fits 1/8", 3/16" and 1/4" panel thicknesses. Molded of durable nylon 6/6. ASTM D-4066 flammability classification 94V-2.

black

part no.	maximum panel thickness	length
5086	.125"	100'
5090	.187"	100'
5094	.250"	100'

clamps & grommets

Liquid Tight Strain Relief Cord Connectors

These cord connectors are used to secure a power supply cord to a piece of electrical equipment. Provides a liquid-tight seal on your power cord entry and reduces wire stress at connection point. Choose from standard dome nut for strain relief or flex nut type, which includes the strain relief to help prevent cable kinking. Designed with vibration-proof protection up to 70 psi. Internationally approved to UL, CSA, VDE and SVE specifications. Seal meets IP68 requirements and is suitable for NEMA 4 and 6 connectors. Manufactured from nylon material with a TPE gland seal to help resist dust, salt water, weak acids, weak alkalis, alcohol, ester, ketone, ether, benzene, gas, mineral and animal and vegetable oils. NPT (National Pipe Thread) is the North American standard. PG is the European standard. Operating temp: -30°C to 100°C (-22°F to 212°F).



Scan for pricing or go to www.delcity.net/catalogpricing



NPT style hub standard type

part no.	standard size	diameter range	max hole clearance	overall length
2638	3/8"	.157"-.314"	.675"	1.692"
2612	1/2"	.236"-.472"	.825"	1.734"
2634DL	3/4"	.511"-.708"	1.050"	1.969"
2601	1"	.709"-1.024"	1.303"	2.283"

Nuts sold separately



NPT style hub flex type

part no.	standard size	diameter range	max hole clearance	overall length
2738	3/8"	.157"-.314"	.561"	3.282"
2712	1/2"	.236"-.472"	.825"	4.135"
2734	3/4"	.511"-.708"	1.050"	5.333"

Nuts sold separately



NPT style locking nuts

part no.	standard size	description	mates with
2639	3/8"	locking nut	2638
2613	1/2"	locking nut	2612
2635	3/4"	locking nut	2634
2602DL	1"	locking nut	2601



PG style hub standard type with nut

part no.	standard size (PG#)	diameter range	max hole clearance	overall length
2650	3/8" (9)	.181"-.312"	.599"	1.300"
2653	1/2" (13.5)	.170"-.450"	.804"	1.530"
2656	3/4" (21)	.450"-.705"	1.115"	1.870"
2659	1" (29)	.590"-.990"	1.470"	2.230"

Standard Crimp Terminals

Del City terminals are manufactured of pure electrolytic copper (brass for push-on terminals) properly tempered. When crimping, the copper in the terminal barrel flows into and around the wire strands. The unique flowing ability of the copper terminals results in a fused connection of maximum strength and conductivity. Serration inside the barrels of small terminals (22–10 gauge) provide additional gripping power. Terminals are electro bright tin plated for maximum corrosion prevention.



Scan for pricing or go to www.delcity.net/catalogpricing

Terminal Types

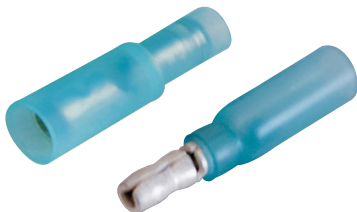

Bullet

- Crimp & Shrink Tube
- Nylon w/Brass Sleeve
- Standard Nylon
- Vinyl



Butt & Parallel Connectors

- Crimp & Shrink Tube
- Solder & Shrink Tube
- Crimp, Solder & Shrink Tube
- Nylon w/Brass Sleeve
- Standard Nylon
- Vinyl
- High-Temp Steel
- Non-Insulated



Push-on (Quick Connect)

- Crimp & Shrink Tube
- Solder & Shrink Tube
- Crimp, Solder & Shrink Tube
- Nylon w/Brass Sleeve
- Standard Nylon
- Funnel Entry Vinyl
- Vinyl
- High-Temp Steel
- Non-Insulated



Spade

- Crimp & Shrink Tube
- Nylon w/Brass Sleeve
- Standard Nylon
- Funnel Entry Vinyl
- Vinyl
- Non-Insulated



Ring

- Crimp & Shrink Tube
- Solder & Shrink Tube
- Crimp, Solder & Shrink Tube
- Nylon w/Brass Sleeve
- Standard Nylon
- Funnel Entry Vinyl
- Vinyl
- High-Temp Steel
- Non-Insulated



Specialty

- Crimp & Shrink Tube
- Nylon w/Brass Sleeve
- Standard Nylon
- Vinyl
- Non-Insulated

Insulation Color Code



22–18 & 8 gauge



16–14 & 6 gauge



12–10 & 4 gauge

STUD SIZE

4



6



8



10



1/4"



5/16"



3/8"



1/2"



INFORMATION

INSTALLATION

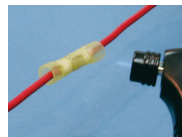
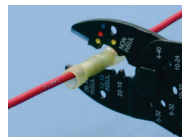
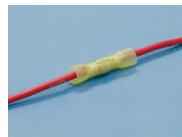
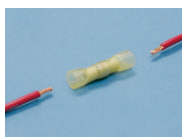

Insulation Types



Scan for pricing or go to www.delcity.net/catalogpricing



non-insulated



high temperature



vinyl-insulated butted seam barrel



vinyl-insulated funnel entry



nylon-insulated reinforced w/brass sleeve



clear nylon-insulated brazed barrel



shrink tube & crimp terminal



crimp, solder & heat shrink

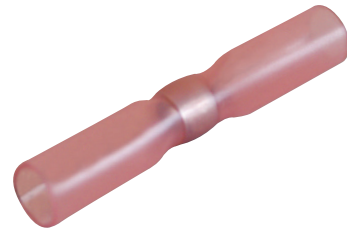

solder & heat shrink

INFORMATION

Non-insulated terminals are the most economical and are used where special performance or insulation characteristics are not necessary. Insulated terminals are used where an insulated barrel is necessary and desirable. Industry standard color coding of insulation indicates proper wire gauge.

Strip Length: 1/4"

Insulation Temperature: 105°C (221°F)

Voltage: 600V maximum, building wire; 1000V maximum, signs and fixtures.

Tools: Follow manufacturing crimping instructions (one crimp only).

Caution: Appropriate electrical codes must be followed in all electrical work. Power must be off prior to installation and removal of wire connectors.

Notice: Sellers and manufacturers only obligation shall be to replace such quantity of the product proved to be defective. Neither seller or manufacturer shall be liable for any injury, loss or damage, direct or consequential, arising out of the use of or the inability to use the product.

INSTALLATION PROCEDURE:

Funnel Barrel Feature provides an excellent electrical and mechanical connection:

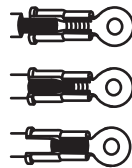

1. Funnel design guides wire into position.
2. No wire strand hang-up as the wire is inserted, giving a fast, positive installation.
3. Wire is in place, ready for crimping. For maximum crimping performance, barrel of connector must be properly indexed in the crimp tool station.

Correct crimping is important to assure a strong connection.

Insulated Terminals & Connectors



Non-insulated Terminals & Connectors



Indent should be opposite the barrel seam.

Bullet Terminals



Scan for pricing or go to www.delcity.net/catalogpricing

Adhesive-Lined Shrink Tube Terminals

Ultra Performance

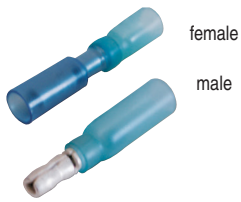

shrink tube - crimp



gauge	male/female	inside width standard		
		.156"	.176"	tubing
16-14	female	961005	962095	.216
16-14	male	962005	962075	.216

min. 10 pcs.

Nylon Insulated Terminals

Premium Performance



nylon w/brass sleeve (double crimp)



gauge	male/female	inside width standard	
		0.156" (stock .030)	0.180" (stock .030)
22-18	male	641205	—
16-14	male	642205	642405

min. 100 pcs.



clear nylon

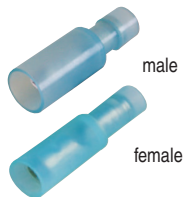

gauge	male/female	inside width standard	
		0.156" (stock .030)	0.180" (stock .030)
22-18	male	841205	841405
16-14	male	842205	842405
inside width fully insulated			
22-18	male	800525	—
16-14	male	800565	—
22-18	female	800725	800925
16-14	female	800735	800935

min. 10 pcs.

Vinyl Insulated Terminals

Standard Performance



vinyl



gauge	male/female	inside width	
		0.156" (stock .020)	0.180" (stock .030)
22-18	male	441205	441405
16-14	male	440205	442405
22-18	female	449105	—
16-14	female	449205	449255
3-way std.**	female	449005	—

** 3-way std. min. 10 pcs.

min. 100 pcs.

Butt Connectors



Scan for pricing or go to www.delcity.net/catalogpricing

Adhesive-Lined Shrink Tube Terminals

Ultra Performance



shrink tube - crimp



gauge	butted seam	seamless	brazed barrel	tubing ID
24-22	920005	—	—	.125
22-18	—	921005	—	.186
16-14	—	922005	—	.216
12-10	—	923005	—	.279
8	—	—	924005	.330

min. 10 pcs.



clear-view shrink tube - crimp



gauge	seamless barrel	tubing ID
22-18	941005	.186
16-14	942005	.216
12-10	943005	.279

min. 10 pcs.



step-down shrink tube - crimp



gauge	part no.	tubing ID
22-18 / 16-14	921115	.186
16-14 / 12-10	922225	.216
12-10 / 8	923335	.279

min. 10 pcs.



multi-wire shrink tube - crimp



gauge		part no.	tube color	tubing ID
1 wire	2 wire			
24-22	24-22	940000	clear/white dash	.220
22-18	20-18	940005	clear/red dash	.300
16-14	16-14	940010	clear/blue dash	.350
12-10	12-10	940015	clear/yellow dash	.450

min. 10 pcs.

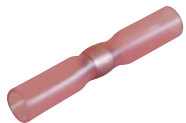

shrink tube - solder



gauge	solder barrel	tubing ID
24-22	966605	.125
20-18	966615	.186
16-14	966625	.216
12-10	966635	.279

min. 10 pcs.



shrink tube - crimp & solder

gauge	brazed barrel	tubing ID
22-18	981005	.186
16-14	982005	.216
12-10	983005	.279

min. 10 pcs.

An ultra performance terminal is best used when moisture and corrosion are a problem. After crimping these terminals to wire, heat is applied enabling the adhesive within each shrink tube terminal to melt and flow evenly for a sealed connection. Our butane power torch #946005 is ideal for shrink-tube terminals. See page 291.



HOW IT WORKS

resist pull-out & fight corrosion

reduce downtime

Nylon Insulated Terminals

Premium Performance

heatless & weather resistant



gauge	seamless	stock
22-18	951005	.030
16-14	952005	.030
12-10	953005	.040

min. 100 pcs.

nylon with brass sleeve (double crimp)



gauge	butted seam	stock
22-18	521005	.030
16-14	522005	.030
12-10	523005	.040

min. 100 pcs.

clear nylon



gauge	brazed barrel	solid barrel	stock
22-18	821005	841005	.030
16-14	822005	842005	.030
12-10	823005	843005	.040

min. 100 pcs.

step-down clear nylon



gauge	solid barrel	stock
26-24 / 22-18	420115DL	.030
22-18 / 16-14	421115	.030
16-14 / 12-10	422115	.030
12-10 / 8	423115	.040

min. 10 pcs.

Vinyl Insulated & Non-Insulated Terminals

Standard Performance

vinyl



gauge	butted seam	stock
22-18	421005	.030
16-14	422005	.030
12-10	423005	.040
8	424005	.050
6	425005	.050
4	426005	.075

8,6,4 ga min. 25 pcs.
min. 100pc

nickel-plated steel, high temperature



gauge	butted seam	stock
22-18	321005	.030
16-14	322005	.030
12-10	323005	.040

min. 100 pcs.
rated to 900°F, 482°C

standard



gauge	brazed barrel	solid barrel	stock
22-18	221005	241005	.030
16-14	222005	242005	.030
12-10	223005	243005	.040

min. 100 pcs.

step-down standard



gauge	solid barrel	stock
26-24 / 22-18	220115	.030
22-18 / 16-14	221115	.030
16-14 / 12-10	222115	.030
12-10 / 8	223115	.040

min. 10 pcs.



Scan for pricing or go to www.delcity.net/catalogpricing



Scan for pricing or go to www.delcity.net/catalogpricing



parallel standard



part no.	wire range	stock
214105	1#22 to 1#22, 20, 18, 16	.030
	1#20 to 1#20, 18, 16	
	1#18 to 1#18	
214205	1#22 to 1#14	.030
	1#20 to 1#14	
	1#18 to 1#16, 14	
	1#16 to 1#16	
214305	1#18 to 1#12, 10	.040
	1#16 to 1#14, 12, 10	
	1#14 to 1#14, 12, 10	
	1#12 to 1#12	
214405	1#18 to 1#8	.050
	1#16 to 1#8	
	1#14 to 1#8	
	1#12 to 1#10	
214505	1#14 to 1#6	.050
	1#12 to 1#8, 6	
	1#10 to 1#10, 8, 6	
	1#8 to 1#8	
214605	1#12 to 1#4	.075
	1#10 to 1#4	
	1#8 to 1#6	

min. 10 pcs.

Crimping Tool – Non-Insulated/Insulated



Crimps 26–10 gauge insulated and 22–10 gauge non-insulated terminals. Scissor action strips stranded 26–10 AWG and solid 18–8 AWG wire. Two convenient wire cutting stations. Cuts and rethreads 4–40, 6–32, 8–32, 10–24, and 10–32 machine screws. Crimps 7–8mm ignition terminals. Included in kits 277 and 809 (see kit section beginning on page 90-98).

part no.	description	crimps gauges
990141	multi-purpose hand crimp tool	22–10 ga, 26–10 ga

Ratchet Crimping Tool – Open/Insulated



990163

Tool 990163 crimps both standard and reinforced (double crimp) terminals in 22–10 gauge. Tool 990168 crimps OEM (open barrel) terminals in 22–12 gauge. Both tools will not disengage until uniform crimp is completed or quick release lever is triggered. Dies have printed key for proper crimp nest.

part no.	description	crimps gauges
990163	ratchet crimping tool	22–10 ga
990168	OEM ratchet crimping tool	22–12 ga



990168

Crimping Tool – Shrink Tube



Each cavity is designed to deliver the crimping force that ensures a solid connection without causing damage to heat shrink. Ratcheting mechanism delivers the proper amount of force to each connector. Crimps 24–10 gauge.

part no.	description	crimps gauges
990020	heat shrink, solder sleeve crimping tool	24–10 ga

Push-On Terminals



Scan for pricing or go to www.delcity.net/catalogpricing

Adhesive-Lined Shrink Tube Terminals

Ultra Performance

shrink tube—crimp



gauge	male/female	fully insulated		tubing ID
		inside width .250"		
22-18	female	964005		.186
16-14	female	964205		.216
12-10	female	964405		.279
22-18	male	964105		.186
16-14	male	964305		.216
12-10	male	964505		.279

min. 10 pcs.

shrink tube—solder

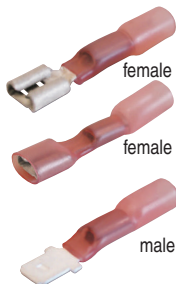

gauge	male/female	standard	fully-insulated	tubing ID
		inside width .250"		
22-18	female	966815	966715	.186
16-14	female	966835	966735	.216
12-10	female	966855	966755	.279
20-18	male	966725	—	.186
16-14	male	966745	—	.216
12-10	male	966765	—	.279

min. 10 pcs.

shrink tube—crimp & solder

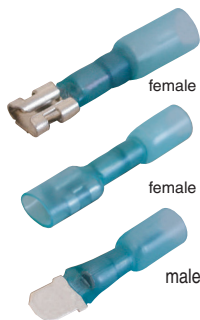

gauge	male/female	standard	fully-insulated	tubing ID
		inside width .250"		
22-18	female	977815	977715	.186
16-14	female	977835	977735	.216
12-10	female	977865	977755	.279
20-18	male	977725	—	.186
16-14	male	977745	—	.216
12-10	male	977765	—	.279

min. 10 pcs.

Nylon Insulated Terminals

Premium Performance

nylon w/brass sleeve (double crimp)

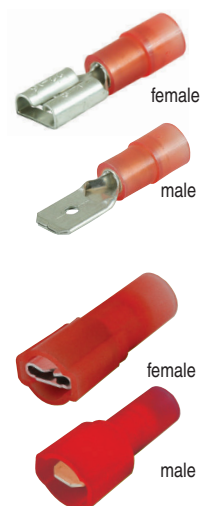

gauge	male/female	inside width standard		
		0.110" (stock .020)	0.187" (stock .020)	0.250" (stock .032)
22-18	female	—	691705	691005
16-14	female	692115	692705	692005
12-10	female	—	—	693005
22-18	male	—	631705	631005
16-14	male	—	632705	632005
12-10	male	—	—	633005
inside width fully insulated				
26-20	female	—	—	—
22-18	female	—	690185	690005
16-14	female	—	694185	694005
12-10	female	—	—	695005
22-18	male	—	630185	630005
16-14	male	—	634185	634005
12-10	male	—	—	635005

min. 100 pcs.

terminals

Nylon Insulated Terminals

Premium Performance



Scan for pricing or go to www.delcity.net/catalogpricing

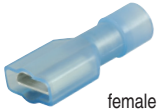
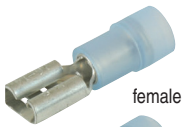

clear nylon ✓ RoHS

gauge	male/female	inside width standard		
		0.110" (stock .020)	0.187" (stock .020)	0.250" (stock .032)
22-18	female	—	891705	891005
16-14	female	—	892705	892005
12-10	female	—	—	893005
22-18	male	—	831705	831005
16-14	male	—	832705	832005
12-10	male	—	—	833005
inside width fully insulated				
26-20	female	—	—	—
22-18	female	—	890185	890005
16-14	female	—	894185	894005
12-10	female	—	—	895005
22-18	male	—	830185	830005
16-14	male	—	834185	834005
12-10	male	—	—	835005

min. 100 pcs.



flag style, clear nylon ✓ RoHS

gauge	inside width standard		
	0.110" (stock .020)	0.187" (stock .020)	0.250" (stock .020)
22-18	—	—	894105
16-14	—	—	894205

may require special crimp tool, min. 100 pcs.



piggy-back nylon

gauge	inside width standard	
	.250" (stock .032)	
22-18	900665	
16-14	900675	

min. 100 pcs.

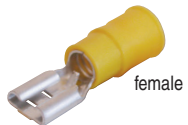

vinyl, funnel entry ✓ RoHS

gauge	male/female	inside width standard	
		0.187" (stock .020)	0.250" (stock .032)
22-18	female	591705	591005
16-14	female	592705	592005
12-10	female	—	593005
22-18	male	531705	531005
16-14	male	532705	532005
12-10	male	—	533005

min. 100 pcs.



Scan for pricing or go to www.delcity.net/catalogpricing



vinyl



gauge	male/female	inside width standard		
		0.110" (stock .020)	0.187" (stock .020)	0.250" (stock .032)
22-18	female	491185	491705	491005
16-14	female	492115	492705	492005
12-10	female	—	—	493005
22-18	male	431185	431705	431005
16-14	male	432115	432705	432005
12-10	male	—	—	433005
inside width fully insulated				
22-18	female	—	490185	490105
16-14	female	—	494185	490205
12-10	female	—	—	490305

min. 100 pcs.

vinyl piggy-back



gauge	inside width standard		
	0.110" (stock .020)	0.187" (stock .020)	0.250" (stock .032)
22-18	—	—	400665
16-14	—	—	400675
12-10	—	—	400685

min. 100 pcs.

nickel-plated steel, high temperature

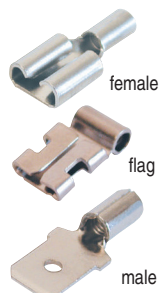

gauge	male/female	inside width
		0.250" (stock .032)
16-14	female	392005
16-14	female flag	392105
16-14	male	332005

min. 100 pcs.
rated to 900°F, 482°C

standard

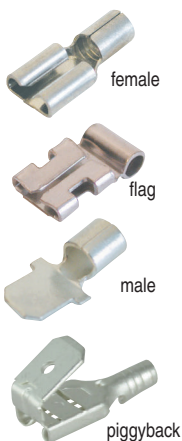

gauge	male/female	inside width	
		0.187" (stock .020)	0.250" (stock .032)
22-18	female	191705	191005
16-14	female	192705	192005
12-10	female	—	193005
22-18	—	—	—
16-14	female flag	192175	192105
12-10	—	—	—
22-18	male	131705	131005
16-14	male	132705	132005
12-10	male	—	133005
20-18	—	—	100665
16-14	—	—	100675
12-10	—	—	100685

min. 100 pcs.

standard adapters



gauge	inside width
	.250"
no. 8 stud	900605
2 to 1 flat	900615
2 to 1 elbow	900625

min. 100 pcs.

Ring Terminals



Scan for pricing or go to www.delcity.net/catalogpricing

DIMENSION CHART

stud size	hole dia.	stud dia.	stud size	hole dia.	stud dia.	stud size	hole dia.	stud dia.	stud size	hole dia.	stud dia.
4	.120	.112	8	.173	.164	1/4"	.266	.250	3/8"	.391	.375
6	.146	.138	10	.198	.190	5/16"	.328	.312	1/2"	.516	.500

STUD SIZE



Adhesive-Lined Shrink Tube Terminals

Ultra Performance



shrink tube - crimp



gauge	stud size								tube ID
	4	6	8	10	1/4"	5/16"	3/8"	1/2"	
22-18	—	951065	951085	951105	951145	951565	951385	—	.186
16-14	—	952065	952085	952105	952145	952565	952385	—	.216
12-10	—	953065	953085	953105	953145	953565	953385	953125	.279
8	—	—	—	954105	954145	954565	954385	954125	.330

min. 10 pcs.



shrink tube - multi-stud crimp



gauge	stud size		tube ID
	6, 8, & 10		
22-18	958105		.186
16-14	959105		.216

min. 10 pcs.



shrink tube - solder



gauge	stud size								tube ID
	4	6	8	10	1/4"	5/16"	3/8"	1/2"	
22-18	—	966405	966415	966425	966435	966445	—	—	.186
16-14	—	966465	966475	966485	966495	966505	966515	—	.216
12-10	—	—	—	966525	966535	966545	966555	966565	.279

min. 10 pcs.



shrink tube - crimp & solder

gauge	stud size								tube ID
	4	6	8	10	1/4"	5/16"	3/8"	1/2"	
22-18	—	971065	971085	971105	971145	971565	971385	—	.186
16-14	—	972065	972085	972105	972145	972565	972385	—	.216
12-10	—	973065	973085	973105	973145	973565	973385	973125	.279

min. 10 pcs.

nylon w/brass sleeve (double crimp)



gauge	stud size								stock
	4	6	8	10	1/4"	5/16"	3/8"	1/2"	
22-18	651045	651065	651085	651105	651145	651565	—	—	.030
16-14	652045	652065	652085	652105	652145	652565	652385	—	.030
12-10	—	653065	653085	653105	653145	653565	653385	653125	.040

min. 100 pcs.

clear nylon



gauge	stud size								stock
	4	6	8	10	1/4"	5/16"	3/8"	1/2"	
22-18	851045	851065	851085	851105	851145	851565	—	—	.030
16-14	852045	852065	852085	852105	852145	852565	852385	—	.030
12-10	—	853065	853085	853105	853145	853565	853385	853125	.040

min. 100 pcs.

vinyl, funnel entry



gauge	stud size								stock
	4	6	8	10	1/4"	5/16"	3/8"	1/2"	
22-18	551045	551065	551085	551105	551145	551565	—	—	.030
16-14	552045	552065	552085	552105	552145	552565	552385	—	.030
12-10	—	553065	553085	553105	553145	553565	553385	553125	.040

min. 100 pcs.

Vinyl Insulated & Non-Insulated Terminals

Standard Performance

vinyl



gauge	stud size								stock
	4	6	8	10	1/4"	5/16"	3/8"	1/2"	
22-18	451045	451065	451085	451105	451145	451565	—	—	.030
16-14	452045	452065	452085	452105	452145	452565	452385DL	—	.030
12-10	—	453065	453085	453105	453145	453565	453385DL	453125	.040
8*	—	—	454085	454105	454145	454565	454385	454125	.050
6*	—	—	—	455105	455145	455565	455385	455125	.060
4*	—	—	—	—	456145	456565	456385	456125	.075

8 ga min. 50 pcs., 6-2 ga min. 25 pcs.

nickel-plated steel, high temperature



gauge	stud size								stock
	4	6	8	10	1/4"	5/16"	3/8"	1/2"	
22-18	—	351065	—	351105	351145	—	—	—	.030
16-14	—	352065	—	352105	352145	—	—	—	.030
12-10	—	353065	—	353105	353145	—	353385	—	.040

min. 100 pcs.
rated to 900°F, 482°C

standard



gauge	stud size								stock
	4	6	8	10	1/4"	5/16"	3/8"	1/2"	
22-18	151045	151065	151085	151105	151145	151565	—	—	.030
16-14	152045	152065	152085	152105	152145	152565	152385	—	.030
12-10	—	153065	153085	153105	153145	153565	153385	153125DL	.040
8	—	—	254085	254105	254145	254565	254385	254125	.050
6	—	—	—	255105	255145	255565	255385	255125	.050
4	—	—	—	—	256145	256565	256385	256125	.050
2	—	—	—	—	257145	257565	257385	257125	.050

8 ga min. 50 pcs., 6-2 ga min. 25 pcs., 22-10 ga min. 100 pcs.



Scan for pricing or go to www.delcity.net/catalogpricing

Spade Terminals



Scan for pricing or go to www.delcity.net/catalogpricing

Adhesive-Lined Shrink Tube Terminals

Ultra Performance



shrink tube - crimp



gauge	stud size								stock
	4	6	8	10	1/4"	5/16"	3/8"	1/2"	
22-18	—	961065	961085	961105	—	—	—	—	.030
16-14	—	962065	962085	962105	—	—	—	—	.030
12-10	—	963065	963085	963105	963145	—	—	—	.040

min. 10 pcs.

Nylon & Vinyl Insulated Terminals

Premium Performance



nylon with brass sleeve (double crimp)



gauge	stud size								tubing ID
	4	6	8	10	1/4"	5/16"	3/8"	1/2"	
22-18	660145	660165	660185	660105	—	—	—	—	.186
16-14	660245	660265	660285	660205	—	—	—	—	.216
12-10	—	660365	660385	0135	—	—	—	—	.279

min. 100 pcs.



clear nylon



gauge	stud size								stock
	4	6	8	10	1/4"	5/16"	3/8"	1/2"	
22-18	—	861065	861085	861105	—	—	—	—	.030
16-14	—	862065	862085	862105	—	—	—	—	.030
12-10	—	863065	863085	863105	—	—	—	—	.040

min. 100 pcs.



narrow block, clear nylon



gauge	stud size								stock
	4	6	8	10	1/4"	5/16"	3/8"	1/2"	
22-18	—	860165	860185	860105	—	—	—	—	.030
16-14	—	860265	860285	860205	—	—	—	—	.030
12-10	—	860365	860385	860305	—	—	—	—	.040

min. 100 pcs.



flanged, clear nylon



gauge	stud size								stock
	4	6	8	10	1/4"	5/16"	3/8"	1/2"	
22-18	—	801065	801085	801105	—	—	—	—	.030
16-14	—	802065	802085	802105	—	—	—	—	.030
12-10	—	803065	803085	803105	—	—	—	—	.040

min. 100 pcs.



narrow block, vinyl, funnel entry



gauge	stud size								stock
	4	6	8	10	1/4"	5/16"	3/8"	1/2"	
22-18	560145	560165	560185	—	—	—	—	—	.030
16-14	560245	560265	560285	560205	—	—	—	—	.030
12-10	—	560365	560385	560305	—	—	—	—	.040

min. 100 pcs.



Scan for pricing or go to www.delcity.net/catalogpricing



vinyl



gauge	stud size								stock
	4	6	8	10	1/4"	5/16"	3/8"	1/2"	
22-18	—	461065	461085	461105	—	—	—	—	.030
16-14	—	462065	462085	462105	—	—	—	—	.030
12-10	—	463065	463085	463105	—	—	—	—	.040

min. 100 pcs.



flanged, vinyl



gauge	stud size								stock
	4	6	8	10	1/4"	5/16"	3/8"	1/2"	
22-18	—	401065	401085	401105	—	—	—	—	.030
16-14	—	402065DL	402085	402105	—	—	—	—	.030
12-10	—	403065	403085	403105	—	—	—	—	.040

min. 100 pcs.



standard



gauge	stud size								stock
	4	6	8	10	1/4"	5/16"	3/8"	1/2"	
22-18	—	161065	161085	161105	—	—	—	—	.030
16-14	—	162065	162085	162105	—	—	—	—	.030
12-10	—	163065	163085	163105	—	—	—	—	.040

min. 100 pcs.

Crimping Tool – Non-Insulated/Insulated



For 22-8 gauge non-insulated terminals, 22-14 gauge insulated terminals. Crimps 7mm and 8mm ignition terminals. Strips and cuts wire and also cuts screws. Color-coded crimping nest.

part no.	description	crimps gauges
990145	crimping tool	22-8 ga, 22-14 ga

Crimping Tool – Insulated

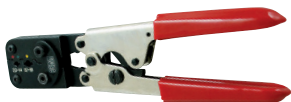

Crimps 22-10 gauge barrel and insulation terminals and connectors. Also crimps nylon and vinyl-insulated, butted or brazed seam and standard or short barrel terminals. Spring-loaded locator orients, positions and holds terminal and connector. Must be fully closed before tool allows itself to open, to ensure a proper crimp.

part no.	description	crimps gauges
990130	ratchet crimping tool	10-22 ga

Crimping Tool – Non-Insulated/Insulated



Five-station ratchet tool is a single crimp tool with three stations for insulated 22-10 gauge terminals and two stations for non-insulated 22-10 gauge terminals. The five-station feature allows the tool to serve as a low cost ratchet tool for electrical maintenance and construction.

part no.	description	crimps gauges
990135	ratchet crimping tool	22-10 ga

Specialty Terminals



Scan for pricing or go to www.delcity.net/catalogpricing

Adhesive-Lined Shrink Tube Terminals

Ultra Performance



y connectors shrink tube - crimp



gauge	part no.	stud	tubing ID
16-14	965105	8	.216
12-10	965125	8	.279

min. 10 pcs.

Nylon & Vinyl Insulated Terminals

Standard Performance

nylon w/brass sleeve (double crimp) pin



gauge	diameter		stock
	0.080"	0.110"	
22-18	644105	—	.030
16-14	644205	—	.030
12-10	—	644305	.040

min. 100 pcs.

vinyl, funnel entry pin



gauge	pin diameter		stock
	0.080"	0.110"	
22-18	544105	—	.030
16-14	544205	—	.030
12-10	—	544305	.040

min. 100 pcs.

Vinyl Insulated & Non-Insulated Terminals

Standard Performance



x and y connectors



gauge	x style	y style	stud size	stock
16-14	410205	411205	8	.030

min. 25 pcs.

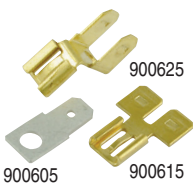

standard adapter



gauge	inside width	
	.250"	
no. 8 stud	900605	
2 to 1 flat	900615	
2 to 1 elbow	900625	

min. 100 pcs.

The FirstMate™ Marine Electrical Repair Kit

The security you need to set sail with confidence. This kit is stocked with premium nylon double crimp terminals, single wall shrink tube pieces, natural and UV black cable ties, UL approved tinned wire and a crimping tool. There is a little bit of everything for marine applications in this kit. All contained within a durable, lightweight, carrying case (10-3/4" x 7-1/2" x 3-1/4"). **For a complete listing of kit contents, see page 327.**



part no.	description	pieces
415	FirstMate™ repair kit	230



Scan for pricing or go to www.delcity.net/catalogpricing

Vinyl Insulated Terminal Assortment Kits

These kits contain a wide variety of our most popular vinyl-insulated crimp-on terminals. Kit 802 contains a crimping tool for convenience. Kit 802 and 803 are contained within a durable, lightweight, translucent carrying case (11" x 6-3/4" x 1-3/4", kit 806 is contained in a 7" x 5" x 1-1/2" case). **For a complete listing of kit contents, see page 329.**



part no.	description	pieces
802	vinyl insulated kit w/crimp tool	132
803	vinyl terminal kit	131
806	vinyl terminal kit	82

The FixIt™ Electrical Repair Kit – Twin Kit™ Series

This kit offers quick, convenient, high-quality products in one handy case. It's packed with fuses, terminals, shrink tube, wire and wire splices, wire nuts, cable ties and grommets. Also included: steel cleaning brush, battery and alternator tester, crimp tool and screwdrivers. All contained within a durable, lightweight, carrying case (10-3/4" x 7-1/2" x 3-1/4"). **For a complete listing of kit contents, see page 326.**



part no.	description	pieces
410DL	FixIt™ electrical repair kit	399

Vinyl Insulated Terminal Assortment Kits

Both kits contain an assortment of vinyl-insulated terminals. Choose kit 275 with a crimping tool, or kit 276 without a crimping tool. Both are contained within a rugged gray metal box (18" x 12" x 3"). **For a complete listing of kit contents, see page 325.**



part no.	description	pieces
275DL	vinyl insulated kit w/crimp tool	469
276	vinyl terminal kit	468

terminals

Rack for Metal Boxes

Heavy-duty, rugged metals racks, in a gray hammerstone finish, holds up to 4 metal scoop boxes. **Order boxes separately, see page 295.**

part no.	description	fits box no.	fits kit no.	weight (lbs)
990275	4 drawer rack for 13 ³ / ₁₆ " x 9 ¹ / ₄ " x 2" boxes h: 11 ¹ / ₄ ", w: 15 ¹ / ₄ ", d: 11 ³ / ₄ "	990250 990265	650	22
990280	4 drawer rack for 18" x 12" x 3" boxes h: 15", w: 20", d: 15 ³ / ₄ "	990255 990255	275, 276, 277 75045, 75043	37

Table Top Wire Rack & Terminal Kit

This versatile wire rack comes with a sliding top drawer that houses scoop box that comes with an assortment of terminals. Rack can hold a wide combination of 100' to 500' spools of assorted wires. It is manufactured from heavy-duty powder coated steel for durability. Available with and without terminals.

part no.	description
9900815	table top wire rack & terminal kit
9900816	table top wire rack only

Crimp & Shrink Tube Terminal Kit – Grab-N-Go Jars

A starter kit that contains multiple sized crimp and shrink tube butt connectors for professional waterproof connections. It features the most popular size connectors (covering 12-10, 16-14 and 20-18 gauge). The jar has a flip top opening for easy pour and is approximately 2.625" X 2.625" X 4.375".

For a complete listing of kit contents, see page 330.

part no.	description	pieces
8911	22-18 ga, shrink tube butt connector Grab-N-Go jar	150
891	shrink tube butt connector Grab-N-Go jar	100
8912	16-14 ga, shrink tube butt connector Grab-N-Go jar	125
8913	12-10 ga, shrink tube butt connector Grab-N-Go jar	75

Mobile Wire Cart

Perfect for maintenance facilities, garages and construction sites, the mobile wire spool and product rack provides efficiency and space to your work environment. The mobile cart allows for multiple types of wire or other spooled items such as loom to be organized and readily available. It features four 5" x 1-1/4" polyurethane casters (2 fixed, 2 free), two louvered side panels for 4" x 5" plastic (Del City product 9900811) and 4" x 8" metal bins (Del City product 9900813). It is manufactured from heavy-duty, all welded 14 gauge steel and has a 1,200 lb capacity. 26" W x 18" D x 46" H.

part no.	description
9900810	mobile wire cart (bins not included)
9900811	yellow plastic bins, 4" X 5"
9900812	yellow plastic bins, 4" X 8"
9900813	adjustable metal shelf, 4" X 18"
9900814	mobile wire cart w/bins

Automotive Electrician's Tote

This kit contains a large assortment of the most commonly used products when working on a installation job. The bottom drawer is compartmentalized to keep small items easy to find and organized. Kit includes terminals, cable ties, shrink tube, wire, tools and tape.

For a complete listing of kit contents, see page 328.

part no.	description	pieces
9900800	automotive electricians kit	618



Scan for pricing or go to www.delcity.net/catalogpricing



terminals



Crimp & Shrink Terminal Kit – *The Defender™*

Palm-size convenience and ultimate performance all in one box. It features our most popular shrink tube butt connectors (12–10, 16–14 and 20–18 gauge). All contained within a durable, lightweight, translucent carrying case (7" x 3" x 1-1/2").

For a complete listing of kit contents, see page 329.

part no.	description	pieces
810	Defender™ shrink tube terminal kit	75



Scan for pricing or go to www.delcity.net/catalogpricing



Solder & Shrink Tube Terminal Kit – *Grab-N-Go Jars*

A starter kit that contains multiple and same sized solder and shrink tube butt connectors for professional waterproof connections. It features the most popular size connectors (covering 12-10, 16-14 and 20-18 gauge). The jar has a flip top opening for easy pour and is approximately 2.625" X 2.625" X 4.375".

For a complete listing of kit contents, see page 330.

part no.	description	pieces
894	solder and shrink tube connector Grab-N-Go assortment jar	100
8941	20-18 gauge solder and shrink tube connector Grab-N-Go jar	100
8942	16-14 gauge solder and shrink tube connector Grab-N-Go jar	100
8943	12-10 gauge solder and shrink tube connector Grab-N-Go jar	60



Crimp, Solder & Shrink Tube Terminal Kit – *Grab-N-Go Jars*

A starter kit that contains multiple and same sized crimp, solder and shrink tube butt connectors for professional waterproof connections. It features the most popular size connectors (covering 12-10, 16-14 and 20-18 gauge). The jar has a flip top opening for easy pour and is approximately 2.625" X 2.625" X 4.375".

For a complete listing of kit contents, see page 330.

part no.	description	pieces
892	crimp, solder and shrink tube connector Grab-N-Go assortment jar	100
8921	20-18 gauge crimp, solder and shrink tube connector Grab-N-Go jar	100
8922	16-14 gauge crimp, solder and shrink tube connector Grab-N-Go jar	100
8923	12-10 gauge crimp, solder and shrink tube connector Grab-N-Go jar	60



Crimp, Shrink & Solder Terminal Kit – *The MightyMaxxx™*

This kit features the best terminals we offer – shrink tube, solder sleeve and crimpable butt connectors. Kit contains 3 sizes of butt connectors (covering 12–10, 16–14 and 20–18 gauge). All contained within a durable, lightweight, translucent carrying case (7" x 3" x 1-1/2").

For a complete listing of kit contents, see page 329.

part no.	description	pieces
813DL	MightyMaxxx™ shrink tube terminal kit	40



2-1 Multi-Wire Crimp & Shrink Tube Terminal Kit – *Grab-N-Go Jars*

A starter kit that contains multiple and same sized 2-1 multi-wire shrink tube butt connectors for professional waterproof connections. It features the most popular size connectors (covering 12-10, 16-14 and 20-18 gauge). The jar has a flip top opening for easy pour and is approximately 2.625" X 2.625" X 4.375".

For a complete listing of kit contents, see page 330.

part no.	description	pieces
895	2-1 multi-wire crimp and shrink tube connector Grab-N-Go assortment jar	25
8951	2-1 multi-wire 20-18 gauge solder and shrink tube connector Grab-N-Go jar	35
8952	2-1 multi-wire 16-14 gauge solder and shrink tube connector Grab-N-Go jar	25
8953	2-1 multi-wire 12-10 gauge solder and shrink tube connector Grab-N-Go jar	15

terminals

Multiple Wire Terminal Kit – *The Multi-Seal™*

Kit contains six different shrink tube multiple wire butt connectors and multiple wire closed-end connectors in an all-in-one MicroSERIES™ kit. Multiple wire shrink tube butt connectors in 24–22, 20–18, 16–14, 12–10 AWG sizes and multiple wire shrink tube closed-end connectors in 22–14 and 18–10 AWG sizes. Shrink tube is 4:1 shrink, free flow adhesive-lined to complete a waterproof connection seal. All are contained within a durable, lightweight translucent carrying case (11" x 6-3/4" x 1-3/4"). **For a complete listing of kit contents, see page 329.**

part no.	description	pieces
815	Multi-Seal™ multiple gauge terminal kit	28

Crimp & Shrink Terminal Assortment Kit – *The SureSeal™*

A small package that packs a big punch. This kit contains ring terminals, butt connectors and push-on terminals. Terminals in this kit are UL listed and include self-sealing shrink tube. All contained within a durable, lightweight, translucent plastic carrying case (11" x 6-3/4" x 1-3/4"). **For a complete listing of kit contents, see page 329.**

part no.	description	pieces
808	SureSeal™ terminal kit	120

Crimp & Shrink Terminal Assortment Kit with Tools – *The Tuxedo™*

Perfectly suited for most connection projects, this kit is accessorized with both a hand crimper and heat gun. The kit contains ring terminals, butt connectors and push-on terminals. Terminals are UL listed and are self-sealing shrink tube. All contained within a durable, lightweight, translucent plastic carrying case (11" x 6-3/4" x 1-3/4"). **For a complete listing of kit contents, see page 329.**

part no.	description	pieces
809	Tuxedo™ shrink tube terminal kit	122

Crimp, Shrink, & Solder Terminal Kit – *The SuperMaxxx™*

This kit features the crimp, shrink and solder terminals and connectors. It contains 12 different terminals designed to provide an array of connecting options for both small and large jobs. All contained within a light-weight, translucent carrying case (11" x 6-3/4" x 1-3/4"). **For a complete listing of kit contents, see page 329.**

part no.	description	pieces
811DL	Supermaxxx™ performance terminal kit	140

Clear View™ Crimp & Shrink Tube – *Grab-N-Go Jars*

A starter kit that contains multiple sized crimp and Clear View(TM) shrink tube butt connectors for professional waterproof connections. It features the most popular size connectors (covering 12-10, 16-14 and 20-18 gauge). The jar has a flip top opening for easy pour and is approximately 2.625" X 2.625" X 4.375". **For a complete listing of kit contents, see page 330.**

part no.	description	pieces
893	Clear View™ crimp and shrink tube connector Grab-N-Go assortment jar	100
8931	20-18 gauge Clear View™ crimp and shrink tube connector Grab-N-Go jar	100
8932	16-14 gauge Clear View™ crimp and shrink tube connector Grab-N-Go jar	100
8933	12-10 gauge Clear View™ crimp and shrink tube connector Grab-N-Go jar	60



Scan for pricing or go to www.delcity.net/catalogpricing



wire connectors



Hard Plastic Wire Connectors

These wire connectors are color-coded for easy size selection. The tight, square-wire spring makes quick, secure connections for positive continuity. A tough, thermoplastic shell shields against environmental extremes. They resist chemical action from hydrocarbons, dilute acid or alkaline solutions. Their flame-retardant properties resist heat distortion up to 105°C (221°F) and the high-dielectric shell features a deep skirt design to prevent exposure of bare wire. Copper to copper connections only.

part no.	pkg qty	color	wire range
901455	100	red	#18 to #10 (min: 2#14, max: 2#10 w/2#12)
901450	250	red	#18 to #10 (min: 2#14, max: 2#10 w/2#12)
901475	100	gray	#22 to #16 (min: 3#22, max: #20 w/1#22)
901485	100	blue	#22 to #16 (min: 3#22, max: 3#16)
901435	100	orange	#22 to #14 (min: 3#20, max: 4#16 w/1#20)
901430	500	orange	#22 to #14 (min: 3#20, max: 4#16 w/1#20)
901445	100	yellow	#22 to #10 (min: 1#14 w/1#22, max: 4#14)
901440	500	yellow	#22 to #10 (min: 1#14 w/1#22, max: 4#14)



Scan for pricing or go to www.delcity.net/catalogpricing



Winged Hard Plastic Wire Connectors

The wings on these connectors are knurled for a better grip and offset from their centerline for greater twisting leverage. A square-wire plated spring instantly adjusts to the shape and size of the splice. Flame-retardant properties resist heat distortion up to 105°C (221°F). A high-dielectric shell features a deep skirt design to prevent exposure of bare wire. Copper to copper connections only.

part no.	pkg qty	color	wire range
901490	500	yellow	#22 to #10 (min: #2 to #18, max: 3#12)
901500	500	red	#22 to #6 (min: 2#14, max: 5#12)



Grounding Wire Connectors

These connectors are specifically designed for making secure ground connections. They feature the same live-action as the above winged connectors, with the added plating protection for corrosion resistance in grounding applications. The contoured, offset wings enable firm ground connections. A flame retardant, thermoplastic shell resists punctures, cuts, abrasion and corrosion. Solid copper to copper connections only.

part no.	pkg qty	color	wire range
901510	500	green	#14 to #10 (min: 2#14, max: 4#12)



Hex-Lok® Wire Connectors

These wire connectors cover 95% of everyday copper to copper connections. The unique head design allows for socket installation to help relieve hand stress. A square-wire spring grabs and holds wires for a secure connection, and a long skirt covers stripped wires. Rated at 600V max in building wire and at 1000V max in lighting fixtures/luminaries and signs. Copper to copper connections only.

part no.	pkg qty	color	wire range
901550	250	gray	#14 to #6 (min: 3#14, max: 1#6 w/1#8)
901560	500	tan	#22 to #8 (min: 3#22, max: 4#12 w/2#18)



Uni-Lok® Wire Connectors

This versatile connector is manufactured to accept a wide range of wire combinations. The swept mini-wings provide additional torque. A square-wire spring grabs and holds wires for a secure connection, while the long skirt covers stripped wires. Rated at 600V max in building wire and at 1000V max in lighting fixtures/luminaries and signs. Copper to copper connections only.

part no.	pkg qty	color	wire range
901570	500	yellow	#22 to #12 (min: 4#22, max: 3#12)
901580	500	red	#22 to #10 (min: 3#20, max: 5#12)



Scan for pricing or go to www.delcity.net/catalogpricing



wire connectors

Scotchlok 2® Connectors

With an increased wire range, these 3 connector sizes can now do jobs it used to take 8 connector sizes to accomplish. A flexible skirt provides protection and readily bends to conform in tight places. UL and CSA rated. Rated 600V.

part no.	pkg qty	color	wire range
901505	100	blue, orange wing style	2#22 - 2#12
901525	100	yellow, red wing style	2#18 - 2#8 4#14 - 3#12 6#14 - 4#12 5#12 - 3#10
901535	100	gray, blue wing style	4#14 - 5#10

Closed End Connectors

Closed end connectors are used in situations requiring a pigtail of two or more wires. These closed end connectors feature translucent nylon insulation and a tin-plated copper sleeve. Rated to 300V.

part no.	pkg qty	gauge
901205	100	22-18
901215	100	22-14
901225	100	22 -10

Multiple Wire Sealed Close End Connectors with 2:1 Heat Shrink

The extra-active, free-flowing adhesive lining within these connectors encapsulate multiple wires, helping eliminate wire pull-out and making the connection weatherproof. These connectors replace standard closed end connector, and are a superior solution in environments where corrosion is a problem. A clearly marked dashed line helps to quickly identify wire gauge range and crimp die set.

part no.	pkg qty	color	gauge
902205	10	clr/blue dash	22-14
902215	10	clr/yellow dash	18-10

2 to 1 Wire Butt Connector with 4:1 Ratio Shrink Tube

These terminals provide a better way to join two wires to one wire. The extra-active, free-flowing adhesive lining within these connectors encapsulate multiple wires, helping eliminate wire pull-out and making the connection weatherproof. These connectors are a superior solution to the standard quick splice. A clearly marked dashed line helps to quickly identify wire gauge range and crimp die set.

part no.	pkg qty	gauge		tube color	tubing ID
		1 wire	2 wire		
940000	10	24-22	24-22	clear/white dash	.220
940005	10	22-18	20-18	clear/red dash	.300
940010	10	16-14	16-14	clear/blue dash	.350
940015	10	12-10	12-10	clear/yellow dash	.450

wire connectors

Quick Splices

Quick splices are used for quick connections with no wire stripping. Simply insert both wires, squeeze down the metal insert with a pliers and snap the cover in place.

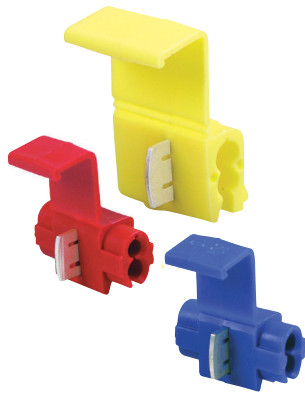

part no.	bag qty	description	gauge
905585	100	red, closed port	22-18
904485			
905605	100	white, open port	18-14
905655			
905595	100	blue, closed port	16-14
904445			
905625	100	yellow, 300V	12-10
904625			
905615	100	brown, 300V	connects 18-10 to 16-12



Scan for pricing or go to www.delcity.net/catalogpricing



Tap Connectors (moisture resistant)

This electrical tap connector contains a mineral oil base dielectric grease. When closed, this grease provides a moisture resistant barrier to destructive substances such as salt water and other corrosive environments. 18-14 gauge, 600V, 90°C (194°F). 18 gauge: 7 amps; 16 gauge: 10 amps; 14 gauge: 15 amps.

part no.	bag qty	description
905665	100	tap connector

INFORMATION

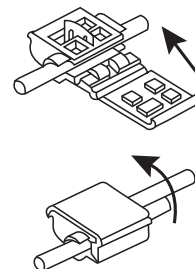

Ox-Gard™ Anti-Oxidant Compound

The perfect safeguard for aluminum to aluminum, or aluminum to copper wire connections and aluminum conduit joints. It guards against oxidation and improves conductivity. Penetrates aluminum oxide to maintain inter-strand and inter-conductor current paths. It produces a cooler connection.

part no.	description
961DL	1 oz squeeze tube
964DL	4 oz squeeze tube



905635

Pigtail Connectors

The self-stripping electrical pigtail connectors are capable of connecting 2 or 3 wires in the range of No. 22 thru No. 14 AWG solid or stranded copper wire. The insulator body and cap are manufactured of a flame retardant nylon and contain an EG-3 grease sealant providing a moisture resistant seal. Connectors are UL Listed and CSA certified for 600V maximum, building wire: 1000V maximum, signs, fixtures and luminaries, and temperature rated 105°C (221°F).

part no.	pkg qty	description	wire gauge
905635	20	sealant waterproof pigtail connector	22-14



Scan for pricing or go to www.delcity.net/catalogpricing

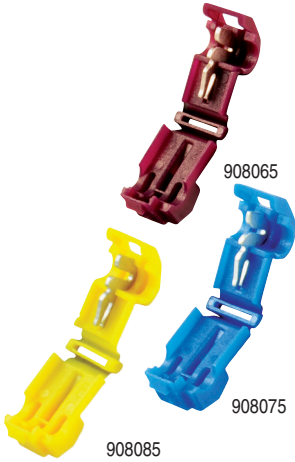

wire connectors

T-tap Female Connectors

The self-stripping T-tap female connectors are capable of connecting to an insulated, solid or stranded copper wire without cutting or stripping the wire. The insulator is made of a flame retardant nylon and the element is tin-plated brass. Close connector over the wire and connect a .250" x .032" male tab push-on to opposite end. Connectors are UL Listed and CSA certified for 600V maximum, building wire: 1000V maximum, signs, fixtures and luminaires, and temperature rated 105°C (221°F). (See terminal section, pages 53–79).

part no.	bag qty	color	gauge	inside width
908065	100	red	22–18 ga	.250"
908075	100	blue	16–14 ga	.250"
908175	100	blue	16–14 ga	.250"
908085	100	yellow	12 ga	.250"

INFORMATION

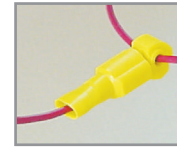
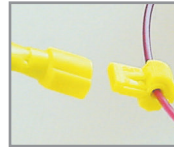
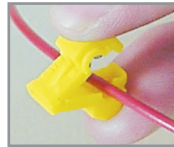

Push-in Connectors

Easy and fast to use; strip wire and push into connector. Clear polycarbonate housings have color-coded side panels for easy verification. Stainless steel springs resist corrosion and restrict wire pull out. Twist left to right for wire removal. Rated to 24 amps, at 600V max in building wire and 1000V AC in lighting fixtures/luminaires. Copper to copper connections only.



part no.	bag qty	description	color coding	wire range
907010	100	2-port	red	#22 to #12 AWG
907020	100	3-port	orange	#22 to #12 AWG
907030	100	4-port	yellow	#22 to #12 AWG
907040	50	8-port	black	#22 to #12 AWG



Tap-in

Electrically tap into a wire in mid-span without cutting or stripping the wire. The connector mates with a .156" male bullet connector, making a reusable plug connect wiring termination. The insulator is polypropylene; the u-contact is tin plated copper. Use with 18–14 AWG solid or stranded, tinned or untinned (.75–1.5 mm2 solid or stranded) copper conductors.

INFORMATION

Rating: 18 AWG = 7 amps
16 AWG = 10 amps
14 AWG = 15 amps

part no.	description	qty	wire gauge
908055	bullet splice	100	18–14

Use With

bullet terminals
PAGES 57

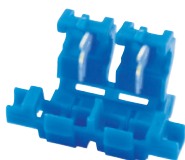

Self-tapping ATC®/ATO® Fuse Holder

The self-tapping design requires no wire stripping. It installs with a common pliers. For use with 18–14 gauge wire and rated to 20 amp max. Fuse not included.

part no.	description	qty	wire gauge
78355	fuse holder	1	18–14

Use With

fuses
PAGE 141



wire connectors

AT Series™ Harsh Environment Sealed Connectors

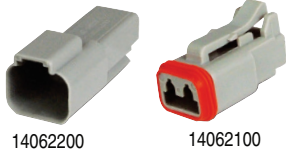

14062200

14062100



14066200

14066100

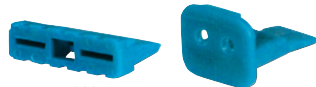

14162200

14162100

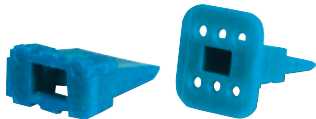

14166200

14166100



14601422



14602013



The sealed housings are made from a thermoplastic material that provides durability and UV resistance. Each receptacle and plug includes a silicone elastomer wire seal to help prevent environmental ingress. To complete an assembly, one receptacle/plug housing, a wedge and appropriate number of pins are required. All AT Series™ assemblies mate directly with Deutsch DT housings/assemblies. The complete assembly connection meets SAE J2030, IP67 and IP69K. The thermoplastic material meets UL94 HB rating, with a temperature rating of -55°C to 125°C (-67°F to 257°F).

description	receptacle	plug
2-way housing	14062200	14062100
3-way housing	14063200	14063100
4-way housing	14064200	14064100
6-way housing	14066200	14066100
8-way housing	14068200	14068100
12-way housing	14061220	14061210

AT Series™ Wedges

Wedges are made from a thermoplastic material and are a necessary component in aligning the plugs/pins into proper position. One wedge is required per receptacle/plug to complete the assembly. (AT Series™ wedges DO NOT interchange with Deutsch DT Series receptacle wedges).

description	receptacle	plug
2-way wedge	14162200	14162100
3-way wedge	14163200	14163100
4-way wedge	14164200	14164100
6-way wedge	14166200	14166100
8-way wedge	14168200	14168100
12-way wedge	14161220	14161210

AT Series™ Pins and Sockets

Pin and socket contacts complete the electrical connection for the AT Series™ housing assembly. There are three different quality grades of contacts available. All feature a copper alloy base with either a standard stamped/formed nickel plate, military solid crimp nickel or gold-plate. The seal plugs are made of silicone elastomer and can be used to plug any open or unused pin/socket. Connector pins and plugs are interchangeable and mate directly with Deutsch DT Series.

description	gauge	pin	socket
stamped/former	16–14	14601422	14621422
stamped/former	18–16	14601622	14621622
gold, solid crimp	18–16	14602023	14622013
nickel, solid crimp	18–16	14602024	14622014
sealing plug	—	14114017	14114017

AT Series™ Removal Tool

This stainless steel tool is designed to easily disassemble the AT Series™ harsh environment sealed connectors. The flat end slides under plug wedges to release them from the housing. The hook end hooks onto the receptacle wedge to release from the housing and it can separate holding fingers to allow for the pin and socket to be removed.

part no.	description
14114100	AT Series™ removal tool

INSTALLATION



Scan for pricing or go to www.delcity.net/catalogpricing



Scan for pricing or go to www.delcity.net/catalogpricing



75010 (female)



75012 (male)
one-way housing



75018 (female)



75020 (male)
three-way housing



male terminal



female terminal



cavity seals



cavity plug

wire connectors

Weather Pack Environmental Connectors

The Weather Pack environmental connectors are designed for the engine compartment of a vehicle. They are also ideal for use in marine, agriculture and other harsh environmental applications. Audible snap-action lock for housing and secondary terminal lock helps reduce terminal stress, provides proper terminal positioning and easy access for service. Stops in cavities to ensure proper insertion of terminals. Indexed nylon housings are rated -40°C to 125°C (-40°F to 257°F). Housing, terminals, plugs and seals are sold separately. Rated up to 20A at 12V DC.

INFORMATION

Three basic environmental seal tests were performed which involved salt, fog, immersion and immersion flex. Between lab tests and millions of miles logged on current vehicles, these connectors have proven reliable and provide a fail-safe environmental connection.

description	tower (female)	shroud (male)
1-way housing	75010	75012
2-way housing	75014	75016
3-way housing	75018	75020
4-way flat housing	75022	75024
4-way square housing	75044	75046
6-way housing	75026	75028

Weather Pack Environmental Terminals

The flex-pin and lap-lock design gives these terminals a positive connection. Dual "tang" lock the terminal into the connector cavity. Cable seal crimp wings reduce strain on the cable core and assure proper positioning of the cable seal. Rated up to 20A at 12V DC.

description	tower (female)	shroud (male)
20-18 gauge terminal	75032	75030
16-14 gauge terminal	75036	75034
12 gauge terminal	75040	75038

Weather Pack Environmental Seals and Plugs

Self-lubricating, silicone seals have multiple "ribs" to guard against dust, moisture, engine compartment fluids and chemicals. Cavity seals are crimped to the terminal to assure positive position of the seal in the housing cavity. The cavity plug is designed to fill and seal unused cavities.

description	color	part no.
22-20 ga	purple	75000
20-18 ga	green	75002
16-14 ga	gray	75004
12 ga	blue	75006
20-18 ga	orange (mylar)	75008
cavity plug	green	75042

ASSEMBLY INSTRUCTIONS

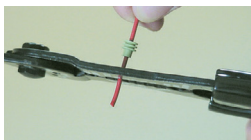

1. Put seal onto cable before stripping insulation.

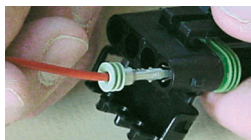

2. Crimp terminal onto stripped wire and seal and insert into connector housing.

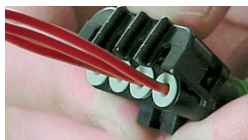

3. Once all terminals are inserted, lock wire and seals as shown above.

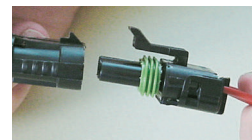

4. Male and female housings connect together until locked once steps 1, 2, and 3 are completed.

wire connectors

Packard Type 56 Series Connector Parts

These quick connectors were standard OEM connectors on American cars from the 50's, 60's, 70's and early 80's. They are available in 1-2-3 or 4 contact housings and the housings have a locking tab for both male and female terminals respectively. Positive contact is made when the bodies are joined and they lock together but can be easily disconnected. Terminals should be attached to wire before insertion into body and can be removed from bodies by using a flat tip to trip the locking tang. Rated up to 15 amps.



Scan for pricing or go to www.delcity.net/catalogpricing

Housings

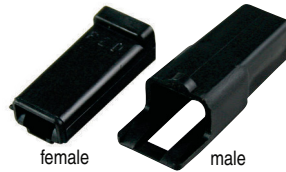

female male

1 contact

part no.	description
945285	body for 1 male terminal
972535	body for 1 female terminal

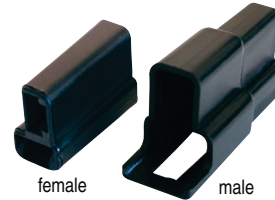

female male

2 contact

part no.	description
937825	body for 2 male terminals
937815	body for 2 female terminals

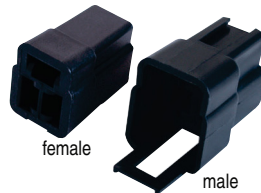

female male

3 contact

part no.	description
946785	body for 3 male terminals
943785	body for 3 female terminals

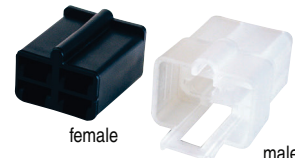

female male

4 contact

part no.	description
970495	body for 4 male terminals
970485	body for 4 female terminals

Terminals



929895

male terminals

part no.	gauge
929895	20-18
929875	16-14



925725

female terminals

part no.	gauge
925725	20-18
925735	16-14

* Terminals are manufactured from brass material; rated for 49 amps



OEM Type Crimping Tools

This tool crimps 20-12 gauge OEM type (open barrel) automotive terminals. There are five crimping stages. Five dies make rollover crimps on both stranding (electrical crimp) and insulation (strain relief crimp). For use on AT and Packard connectors and 929895, 929875, 925735, 925725 (see above).

part no.	description	crimps gauges
990170	open barrel crimping tool	22-12 ga



Scan for pricing or go to www.delcity.net/catalogpricing



85018 female



85020 male

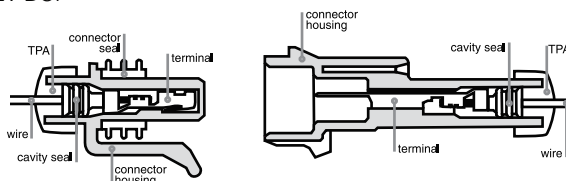

description	female	male
1-way housing	85010	85012
2-way housing	85014	85016
3-way housing	85018DL	85020DL
4-way housing	85022	85024
5-way housing	85026	85028



85042



85040

Metri-Pack® Terminal Position Assurance – TPA

Firmly holds terminals in connector housings. Helps reduce tension between terminal and wire connection. Made from heat stabilized, impact modified Polyamide 66 material. Temperature rating: -40°C to 125°C (-40°F to 257°F).

description	female	male
1-way TPA	85030	85030
2-way TPA	85032	85032
3-way TPA	85034	85036
4-way TPA	85038	85040
5-way TPA	85042	85044



85058 male



85050 female

Metri-Pack® Terminals

Terminals are push-to-seat. Singular "tang" locks terminal into housing, ensuring proper insertion. Tin-plated for added protection from corrosion. Rated up to 30A @ 12V DC.

gauge (mm ²)	female	male
22–20 (.50–.35)	85052	85060
18–16 (1.0–.80)	85050DL	85058
14–12 (3.0–2.0)	85048DL	85056
10 (5.0)	85046DL	85054
Tangless		
22–20 (.50–.35)	12110846	-
18–16 (1.0–.80)	12110847	-
16–14 (3.0–2.0)	12129409	-
14–12 (3.0–2.0)	12110845	-



The Weather Pack™ and Metri-Pack® 150 & 280 Crimp Tool

The Weather Pack™ and Metri-Pack® 150 & 280 Model #T-18 Crimp Tool crimps most Weather Pack™ and the most popular sealed Metri-Pack® 150 and 280 series terminals and seals. The three crimp station nests are designed to crimp 22-14 gauge open barrel terminals. Two additional crimp nests are for seal crimps. "F" crimping nests make rollover crimps on both stranding (electrical crimp) and seal. Crimps the following: Weather Pack part #'s: 75032, 75036, 75040, 75030, 75034 & 75038. Metri-Pack® part #'s: 85052, 85050DL, 85048DL, 85060, 85058, & 85056. Metri-Pack® "Tangless" terminal part #'s: 12110845, 12110846, 12110847, & 12129409. Seal part #'s: 75000, 75002, 75004, 75006, 75008, & 75042. **For a complete listing of kit contents, see page 342.**

part no.	description	gauges
990174	Weather Pack™ & Metri-Pack® crimp tool	22-14

wire connectors



cavity seals



cavity plug

Metri-Pack® Cavity Seals and Plugs

Self-lubricating, silicone seals have multiple “ribs” to guard against dust, moisture, engine compartment fluids and chemicals. Cavity seals are crimped to the terminal to assure positive position of the seal in the housing cavity. The cavity plug is designed to fill and seal unused cavities.

description	color	part no.
22–20 ga	purple	75000
20–18 ga	green	75002
16–14 ga	gray	75004
12 ga	blue	75006
20–18 ga	orange (mylar)	75008
cavity plug	green	75042



Scan for pricing or go to www.delcity.net/catalogpricing



908475



908485



908495



990174

Metri-Pack® Tools

Designed for the positive crimping and removal of Metri-Pack® terminals. Quality tools for long-lasting and dependable service. Removal tool provides for easy removal of terminals. Ratchet assembly ensures a perfect crimp every time.

part no.	description	gauge	OEM #
908475	removal tool	—	12094429
908485	multi-gauge crimper	20–14	12155975
908495	crimper	12–10	12071687
990174	combo crimper	24-14	n/a

Metri-Pack® 280 Sealed Terminal and Seal Kit

The Metri-Pack® 280 kit provides all the essential Metri-Pack® 280 female terminals, seals and cavity plugs. This small kit ensures you have the inventory and is ideal for small projects. Components come in a convenient carrying case (4-1/2"x2-5/8"x1-5/16").

For a complete listing of kit contents, see page 331.



part no.	description	pieces
75053	Metri-Pack® 280 Sealed Terminal and Seal Kit	425



AT Series™ Kit

This kit is an assortment of receptacles, plugs, wedges and terminals that provides a basic offering of the AT Series™ line. The starter kit contains 204 pieces within a durable, lightweight, translucent plastic carrying case (11" x 6-3/4" x 1-3/8").

For a complete listing of kit contents, see page 332.

part no.	description	pieces
14114020	AT Series™ plug, wedge, & receptacle kit	224
14114025	AT Series™ terminal kit with crimp tool	129



Scan for pricing or go to www.delcity.net/catalogpricing



906475



906485



906495



990174

wire connectors

Weather Pack Tools

Designed for the positive crimping of weather pack terminals. Quality tools for long-lasting and dependable service. The removal tool provides for easy removal of terminals. Ratchet assembly assures a perfect crimp every time.

part no.	description	gauge	OEM #
906485	multi-gauge crimper	20-14	12014254
906495	crimper	12 -14	12085270
908495	crimper	12	12071687
906475	removal tool, 1/8"	-	12014012
990174	combo crimper	24-14	n/a



Weather Pack Kit – *microSERIES™*

An excellent starter kit for the weather pack system. Contains an assortment of male and female terminals, as well as seals and plugs. All contained within a durable, lightweight, translucent plastic carrying case (4 1/2" x 25/8" x 15/16").

For a complete listing of kit contents, see page 331.

part no.	description	pieces
75050	weather pack kit	425



Weather Pack Connector Kit

This kit contains everything you need to make a quality weather-resistant connection over and over again. A whopping assortment of 1,280 total pieces, including terminals, seals and housings. All contained within a rugged, gray metal scoop box (18" x 12" x 3").

For a complete listing of kit contents, see page 330.

part no.	description	pieces
75045	weather pack connector kit	1,280



Weather Pack Terminal & Seal Kit w/Tools

A 1,100 piece assortment of both male and female terminals, seals and plugs. Also included are 2 ratchet style crimping tools and 1 terminal removal tool. All contained within a rugged, gray metal scoop box (18" x 12" x 3"). **For a complete listing of kit contents, see page 340.**

part no.	description	pieces
75043	weather pack kit	1,103



Metri-Pack® 280 Tangless Terminal and Seal Kit

The Metri-Pack® 280 tangless kit provides all the essential Metri-Pack® 280 tangless female terminals, seals and cavity plugs. This small kit ensures you have the inventory and is ideal for small projects. Components come in a convenient carrying case (4-1/2"x2-5/8"x1-5/16"). **For a complete listing of kit contents, see page 331.**

part no.	description	pieces
75052	Metri-Pack® 280 Tangless Terminal and Seal Kit	425



Metri-Pack® 280 Sealed Terminal and Seal Kit

The Metri-Pack® 280 kit provides all the essential Metri-Pack® 280 female terminals, seals and cavity plugs. This small kit ensures you have the inventory and is ideal for small projects. Components come in a convenient carrying case (4-1/2"x2-5/8"x1-5/16").

For a complete listing of kit contents, see page 331.

part no.	description	pieces
75053	Metri-Pack® 280 Sealed Terminal and Seal Kit	425

Single Wall 2:1 Shrink Tube Kit – HS 455™

Sealing and securing can now be taken to go! This kit contains 55 6" pieces of **2:1 single wall** polyolefin, flexible type, I.D. ranges 1/8"-1/2" in red, black, yellow and blue. The shrink tube is UL listed and meets MIL-1-23053/5. Excellent for securing and insulating almost any wire connection. All contained within a durable, lightweight, translucent carrying case (7" x 3" x 1-1/2"). **For a complete listing of kit contents, see page 327.**



part no.	description	pieces
553	HS 455™ 2:1 shrink tube kit	55



Scan for pricing or go to www.delcity.net/catalogpricing

Single Wall 2:1 Shrink Tube Kit – The Protector™

Perfect for insulating all of your wire connecting jobs. This kit contains 6" length shrink tube pieces. I.D. ranges 1/8"-3/4" in black, red, blue and yellow. Flame retardant **2:1 single wall** 2-1 polyolefin shrink tube, flexible type. UL listed and meets MIL-1-23053/5. All contained within a durable, lightweight, translucent carrying case (11" x 6-3/4" x 1-3/4"). **For a complete listing of kit contents, see page 327.**



part no.	description	pieces
550	Protector™ 2:1 shrink tube kit	105

Dual Wall 3:1 Shrink Tube Kit – Over-Armor™

This kit is a bit smaller than it's big brother The Brute™ shrink tube kit. It contains 30 pieces of **3:1 dual wall** polyolefin shrink tube, semi rigid type, I.D. ranges from 1/8" to 1/2" in both black and red. UL listed and meets MIL-DTL-23053/4. All contained within a durable, lightweight, translucent carrying case (7" x 3" x 1-1/2"). **For a complete listing of kit contents, see page 327.**



part no.	description	pieces
554	Over-Armor™ 3:1 shrink tube kit	30

Dual Wall 3:1 Shrink Tube Kit – The Brute™

The Brute™ contains sixty-six pieces of 10 different sizes of adhesive-lined polyolefin shrink tube in black & red, 6" cut lengths, I.D. range for 1/8"-1" as supplied. **3:1 dual wall** polyolefin, semi rigid type. UL listed and meets MIL-DTL-23053/4. This shrink tube is flame retardant and self-sealing. All contained within a durable, lightweight, translucent carrying case (11" x 6-3/4" x 1-3/4"). **For a complete listing of kit contents, see page 327.**



part no.	description	pieces
551	Brute™ 3:1 shrink tube kit	66

Translucent Dual Wall 3:1 Shrink Tube Kit – The Professional™

The perfect match for post installation inspection of underlying components. This kit contains eighty-three total pieces of 10 different sized adhesive-lined **3:1 dual wall** polyolefin shrink tube, semi rigid type: in clear, red, blue and yellow; 6" cut lengths, I.D. range from 1/8"-3/4". The shrink tube kit is UL listed and meets MIL-DTL-23053/4, Class 1; AMS3534 (excluding clear shrink tube). The gauge size is imprinted on the translucent, color-coded shrink tube. All contained within a durable, lightweight, translucent carrying case (11" x 6-3/4" x 1-3/4"). **For a complete listing of kit contents, see page 327.**



part no.	description	pieces
552	Professional™ 3:1 shrink tube kit	83



Scan for pricing or go to www.delcity.net/catalogpricing



kits

Shrink Tube Assortment Kit – *The Bully™*

This kit includes **single wall** 6" lengths of 2:1 shrink tube in 1/8", 3/16", 1/4" & 3/8" in red, blue, black and yellow; **3:1 dual wall** 6" lengths of semi rigid heat shrink in 1/4", 3/8", 1/2" & 3/4" in black and clear; 3:1 dual wall 6" lengths of semi rigid shrink tube in 20–18, 16–14 & 12–10 gauge (industry standard colored) translucent tubes and 3:1 triple wall 6" lengths of semi rigid shrink tube in 8 to 1 AWG and 2 to 4/0 in black and red. All are packaged within a rugged gray metal scoop box (18" x 12" x 3"). **For a complete listing of kit contents, see page 328.**

part no.	description	pieces
555	Bully™ shrink tube assortment kit	176



The FirstMate™ Marine Electrical Repair Kit

The security you need to set sail with confidence. This kit is stocked with premium nylon double crimp terminals, single wall shrink tube pieces, natural and UV black cable ties, UL approved tinned wire and a crimping tool. There is a little bit of everything for marine applications in this kit. All contained within a durable, lightweight, carrying case (10-3/4" x 7-1/2" x 3-1/4"). **For a complete listing of kit contents, see page 327.**

part no.	description	pieces
415	FirstMate™ repair kit	230



802

Vinyl Insulated Terminal Assortment Kits

These kits contain a wide variety of our most popular vinyl-insulated crimp-on terminals. Kit 802 contains a crimping tool for convenience. Kit 802 and 803 are contained within a durable, lightweight, translucent carrying case (11" x 6-3/4" x 1-3/4", kit 806 is contained in a 7" x 5" x 1-1/2" case). **For a complete listing of kit contents, see page 329.**

part no.	description	pieces
802	vinyl insulated kit w/crimp tool	132
803	vinyl terminal kit	131
806	vinyl terminal kit	82



806



The FixIt™ Electrical Repair Kit – *Twin Kit™ Series*

This kit offers quick, convenient, high-quality products in one handy case. It's packed with fuses, terminals, shrink tube, wire and wire splices, wire nuts, cable ties and grommets. Also included: steel cleaning brush, battery and alternator tester, crimp tool and screwdrivers. All contained within a durable, lightweight, carrying case (10-3/4" x 7-1/2" x 3-1/4"). **For a complete listing of kit contents, see page 326.**

part no.	description	pieces
410DL	FixIt™ electrical repair kit	399



Scan for pricing or go to www.delcity.net/catalogpricing



275DL



276

Vinyl Insulated Terminal Assortment Kits

Both kits contain an assortment of vinyl-insulated terminals. Choose kit 275 with a crimping tool, or kit 276 without a crimping tool. Both are contained within a rugged gray metal box (18" x 12" x 3"). **For a complete listing of kit contents, see page 325.**

part no.	description	pieces
275DL	vinyl insulated kit w/crimp tool	469
276	vinyl terminal kit	468



Rack for Metal Boxes

Heavy-duty, rugged metals racks, in a gray hammerstone finish, holds up to 4 metal scoop boxes. **Order boxes separately, see page 259.**

part no.	description	fits box no.	fits kit no.	weight (lbs)
990275	4 drawer rack for 13 ⁵ / ₁₆ " x 9 ¹ / ₄ " x 2" boxes h: 11 ¹ / ₄ ", w: 15 ¹ / ₄ ", d: 11 ³ / ₄ "	990250 990265	650	22
990280	4 drawer rack for 18" x 12" x 3" boxes h: 15", w: 20", d: 15 ³ / ₄ "	990255 990255	275, 276, 277 75045, 75043	37

NEW

Table Top Wire Rack & Terminal Kit



This versatile wire rack comes with a sliding top drawer that houses 18" x 12" x 2" size scoop box that comes with an assortment of terminals. Rack can hold a wide combination of 100' to 500' spools of assorted wires. It is manufactured from heavy-duty powder coated steel for durability. Available with and without terminals. 11 7/8" D x 16 7/16" H x 15 3/16" W.

part no.	description
9900815	table top wire rack & terminal kit
9900816	table top wire rack only



Crimp & Shrink Tube Terminal Kit – Grab-N-Go Jars

A starter kit that contains multiple sized crimp and shrink tube butt connectors for professional waterproof connections. It features the most popular size connectors (covering 12-10, 16-14 and 20-18 gauge). The jar has a flip top opening for easy pour and is approximately 2.625" X 2.625" X 4.375".

For a complete listing of kit contents, see page 319.

part no.	description	pieces
8911	22-18 ga, shrink tube butt connector Grab-N-Go jar	150
891	shrink tube butt connector Grab-N-Go jar	100
8912	16-14 ga, shrink tube butt connector Grab-N-Go jar	125
8913	12-10 ga, shrink tube butt connector Grab-N-Go jar	75



Scan for pricing or go to www.delcity.net/catalogpricing

NEW

Mobile Wire Cart



Perfect for maintenance facilities, garages and construction sites, the mobile wire spool and product rack provides efficiency and space to your work environment. The mobile cart allows for multiple types of wire or other spooled items such as loom to be organized and readily available. It features four 5" x 1-1/4" polyurethane casters (2 fixed, 2 free), two louvered side panels for 4" x 5" plastic (part number 9900811) and 4" x 8" metal bins (part number 9900813). It is manufactured from heavy-duty, all welded 14 gauge steel and has a 1,200 lb capacity. 26" W x 18" D x 46" H.

part no.	description
9900810	mobile wire cart (bins not included)
9900811	yellow plastic bins, 4" X 5"
9900812	yellow plastic bins, 4" X 8"
9900813	adjustable metal shelf, 4" X 18"
9900814	mobile wire cart w/bins

NEW

Automotive Electrician's Tote



This kit contains a large assortment of the most commonly used products when working on a installation job. The bottom drawer is compartmentalized to keep small items easy to find and organized. Kit includes terminals, cable ties, shrink tube, wire, tools and tape.

For a complete listing of kit contents, see page 328.

part no.	description	pieces
9900800	automotive electricians kit	618



Crimp & Shrink Terminal Kit – The Defender™

Palm-size convenience and ultimate performance all in one box. It features our most popular shrink tube butt connectors (12–10, 16–14 and 20–18 gauge). All contained within a durable, lightweight, translucent carrying case (7" x 3" x 1-1/2").

For a complete listing of kit contents, see page 329.

part no.	description	pieces
810	Defender™ shrink tube terminal kit	75



Solder & Shrink Tube Terminal Kit – Grab-N-Go Jars

A starter kit that contains multiple and same sized solder and shrink tube butt connectors for professional waterproof connections. It features the most popular size connectors (covering 12-10, 16-14 and 20-18 gauge). The jar has a flip top opening for easy pour and is approximately 2.625" X 2.625" X 4.375".

For a complete listing of kit contents, see page 330.

part no.	description	pieces
894	solder and shrink tube connector Grab-N-Go assortment jar	100
8941	20-18 gauge solder and shrink tube connector Grab-N-Go jar	100
8942	16-14 gauge solder and shrink tube connector Grab-N-Go jar	100
8943	12-10 gauge solder and shrink tube connector Grab-N-Go jar	60

Crimp, Solder & Shrink Tube Terminal Kit – Grab-N-Go Jars



A starter kit that contains multiple and same sized crimp, solder and shrink tube butt connectors for professional waterproof connections. It features the most popular size connectors (covering 12-10, 16-14 and 20-18 gauge). The jar has a flip top opening for easy pour and is approximately 2.625" X 2.625" X 4.375".

For a complete listing of kit contents, see page 330.

part no.	description	pieces
892	crimp, solder and shrink tube connector Grab-N-Go assortment jar	100
8921	20-18 gauge crimp, solder and shrink tube connector Grab-N-Go jar	100
8922	16-14 gauge crimp, solder and shrink tube connector Grab-N-Go jar	100
8923	12-10 gauge crimp, solder and shrink tube connector Grab-N-Go jar	60



Scan for pricing or go to www.delcity.net/catalogpricing

Crimp, Shrink & Solder Terminal Kit – The MightyMaxx™



This kit features the best terminals we offer – shrink tube, solder sleeve and crimpable butt connectors. Kit contains 3 sizes of butt connectors (covering 12–10, 16–14 and 20–18 gauge). All contained within a durable, lightweight, translucent carrying case (7" x 3" x 1-1/2").

For a complete listing of kit contents, see page 329

part no.	description	pieces
813DL	MightyMaxx™ shrink tube terminal kit	40

2-1 Multi-Wire Crimp & Shrink Tube Terminal Kit – Grab-N-Go Jars



A starter kit that contains multiple and same sized 2-1 multi-wire shrink tube butt connectors for professional waterproof connections. It features the most popular size connectors (covering 12-10, 16-14 and 20-18 gauge). The jar has a flip top opening for easy pour and is approximately 2.625" X 2.625" X 4.375".

For a complete listing of kit contents, see page 330.

part no.	description	pieces
895	2-1 multi-wire crimp and shrink tube connector Grab-N-Go assortment jar	25
8951	2-1 multi-wire 20-18 gauge solder and shrink tube connector Grab-N-Go jar	35
8952	2-1 multi-wire 16-14 gauge solder and shrink tube connector Grab-N-Go jar	25
8953	2-1 multi-wire 12-10 gauge solder and shrink tube connector Grab-N-Go jar	15

Multiple Wire Terminal Kit – The Multi-Seal™



Kit contains six different shrink tube multiple wire butt connectors and multiple wire closed-end connectors in an all-in-one MicroSERIES™ kit. Multiple wire shrink tube butt connectors in 24–22, 20–18, 16–14, 12–10 AWG sizes and multiple wire shrink tube closed-end connectors in 22–14 and 18–10 AWG sizes. Shrink tube is 4:1 shrink, free flow adhesive-lined to complete a waterproof connection seal. All are contained within a durable, lightweight translucent carrying case (11" x 6-3/4" x 1-3/4"). **For a complete listing of kit contents, see page 329.**

part no.	description	pieces
815	Multi-Seal™ multiple gauge terminal kit	28



Scan for pricing or go to www.delcity.net/catalogpricing



kits

Crimp & Shrink Terminal Assortment Kit – *The SureSeal™*

A small package that packs a big punch. This kit contains ring terminals, butt connectors and push-on terminals. Terminals in this kit are UL listed and include self-sealing shrink tube. All contained within a durable, lightweight, translucent plastic carrying case (11" x 6-3/4" x 1-3/4"). **For a complete listing of kit contents, see page 329.**

part no.	description	pieces
808	SureSeal™ terminal kit	120



Crimp & Shrink Terminal Assortment Kit with Tools – *The Tuxedo™*

Perfectly suited for most connection projects, this kit is accessorized with both a hand crimper and heat gun. The kit contains ring terminals, butt connectors and push-on terminals. Terminals are UL listed and are self-sealing shrink tube. All contained within a durable, lightweight, translucent plastic carrying case (11" x 6-3/4" x 1-3/4"). **For a complete listing of kit contents, see page 329.**

part no.	description	pieces
809	Tuxedo™ shrink tube terminal kit	122



Crimp, Shrink, & Solder Terminal Kit – *The SuperMaxxx™*

This kit features the crimp, shrink and solder terminals and connectors. It contains 12 different terminals designed to provide an array of connecting options for both small and large jobs. All contained within a light-weight, translucent carrying case (11" x 6-3/4" x 1-3/4"). **For a complete listing of kit contents, see page 329.**

part no.	description	pieces
811DL	Supermaxxx™ performance terminal kit	140



Clear View™ Crimp & Shrink Tube – *Grab-N-Go Jars*

A starter kit that contains multiple sized crimp and Clear View(TM) shrink tube butt connectors for professional waterproof connections. It features the most popular size connectors (covering 12-10, 16-14 and 20-18 gauge). The jar has a flip top opening for easy pour and is approximately 2.625" X 2.625" X 4.375". **For a complete listing of kit contents, see page 330.**

part no.	description	pieces
893	Clear View™ crimp and shrink tube connector Grab-N-Go assortment jar	100
8931	20-18 gauge Clear View™ crimp and shrink tube connector Grab-N-Go jar	100
8932	16-14 gauge Clear View™ crimp and shrink tube connector Grab-N-Go jar	100
8933	12-10 gauge Clear View™ crimp and shrink tube connector Grab-N-Go jar	60



Clear-View™ Crimp & Shrink Terminal & Heat Shrink Tube Kit – *The Clear-Maxxx™*

This kit features all three Clear-View™ butt connectors and Clear-View™ heat shrink in three different sizes. It contains 125 total pieces, including 20–18, 16–14, and 12–10 gauge butt connectors and 6" pieces of heat shrink. All are contained within a durable, lightweight, translucent carrying case (11" x 6-3/4" x 1-3/4"). **For a complete listing of kit contents, see page 330.**

part no.	description	pieces
818	Clear-Maxxx™ terminal kit	125



Crimp & Shrink Terminal Assortment Kit with Tools – *The Tanker™*

All of the ammunition you need to get the job done. This kit contains ring terminals, butt connectors, push-on terminals, a crimping tool and a heat gun. Self-sealing heat shrink terminals are UL listed. All items are contained within a rugged gray metal scoop box (18" x 12" x 3"). **For a complete listing of kit contents, see page 325.**

part no.	description	pieces
277	Tanker™ shrink tube terminal kit	282



Scan for pricing or go to www.delcity.net/catalogpricing



Crimp, Shrink & Solder Terminal Assortment Kit – *The MegaMaxx™*

This kit features the ultimate terminals – shrink tube, solder sleeve and crimpable connectors. It contains 12 different terminals designed to provide an array of connecting options for both small and large jobs. All contained within a rugged gray metal box (18" x 12" x 3").

For a complete listing of kit contents, see page 325.

part no.	description	pieces
278	Megamaxx™ performance terminal kit	200



Mini® Fuse Kit

Organization that fits in the palm of your hand. This kit contains eight different color-coded, fast acting, Mini® fuses. Ten pieces each of 4–30 amp fuses. All contained within a durable, lightweight, translucent plastic carrying case (4-1/2" x 2-5/8" x 1-5/16").

For a complete listing of kit contents, see page 326.

part no.	description	pieces
305	Mini® fuse kit	80



ATO® Fuse Kits

These fuse kits offer an excellent combination of fuses so that you are always prepared. They are a convenient and inexpensive way to protect your circuits. Kit 303 contains an assortment of ATO® fuses ranging from 3 amps to 30 amps in a 10-compartment plastic box (7-1/2" x 4" x 1-3/8"). Kit 304 contains an assortment of ATO® fuses ranging from 3 amps to 30 amps inside an 8-compartment plastic box (5" x 4-1/4" x 1-1/4").

For a complete listing of kit contents, see pages 326-327.

part no.	description	pieces
303	ATO® fuse kit	160
304	ATO® fuse kit	80



Mult Fuse Kit

This ATC and ATO fuse kit provides a convenient and economical way to protect your circuits. The kit is small enough for easy handling and contains an assortment of ATC®/ATO® and Mini™ fuses ranging from 5A to 30A and tap-ins inside a convenient carrying case (4-1/2"x2-5/8"x1-5/16").

For a complete listing of kit contents, see pages 327.

part no.	description	pieces
307	multi fuse and tap-in kit	180



Scan for pricing or go to www.delcity.net/catalogpricing



kits

The SafeGard™ Multi Fuse Kit

The Safeguard™ Multi Fuse Kit contains the most popular ATO®, Mini® and AGC® fuses and fuse holders. A variety of amps are included giving you more options for circuit protection. All contained within a durable, lightweight, translucent plastic carrying case (11" x 6-3/4" x 1-3/4"). **For a complete listing of kit contents, see page 326.**

part no.	description	pieces
306	SafeGard™ multi fuse kit	203



Weather Pack Kit – microSERIES™

This kit is an excellent starter kit for the Weather Pack system. It contains an assortment of male and female terminals, seals and plugs. All contained within a durable, lightweight, translucent plastic carrying case (4-1/2" x 2-5/8" x 1-5/16").

For a complete listing of kit contents, see page 331.

part no.	description	pieces
75050	weather pack kit	425



Weather Pack Connector Kit

This kit contains an assortment of both male and female terminals, seals and plugs. Both Weather Pack ratchet crimp and removal tools complete the kit that is ideal for any repair or installation job. All items are contained within a rugged, gray material scoop box (18" x 12" x 3").

For a complete listing of kit contents, see page 330.

part no.	description	pieces
75043	weather pack kit	1,103



Weather Pack Terminal & Seal Kit w/Tools

This kit contains everything you need to make a quality weather-resistant connection over and over again. A whopping assortment of 1,280 total pieces, including terminals, seals and housings. All contained within a rugged, gray metal scoop box (18" x 12" x 3").

For a complete listing of kit contents, see page 330.

part no.	description	pieces
75045	weather pack connector kit	1,280



AT Series™ Kit

This kit is an assortment of receptacles, plugs, wedges and terminals that provides a basic offering of the AT Series™ line. The starter kit contains 224 pieces within a durable, lightweight, translucent plastic carrying case (11" x 6-3/4" x 1-3/8").

For a complete listing of kit contents, see page 332.

part no.	description	pieces
14114020	AT Series™ plug, wedge, & receptacle kit	224



AT Series™ Kit w/Tools

This kit is an assortment of receptacles, plugs, wedges, terminals and crimp tool that provides the basic of the AT Series™ line. The starter kit contains 129 total pieces within a durable, light-weight, translucent, plastic carrying case (11" x 6-3/4" x 1-3/8").

For a complete listing of kit contents, see page 332.

part no.	description	pieces
14114025	AT Series™ kit w/ crimper	129

Metri-Pack® 280 Tangless Terminal and Seal Kit

The Metri-Pack® 280 tangless kit provides all the essential Metri-Pack® 280 tangless female terminals, seals and cavity plugs. This small kit ensures you have the inventory and is ideal for small projects. Components come in a convenient carrying case (4-1/2"x2-5/8"x1-5/16"). **For a complete listing of kit contents, see page 330.**



part no.	description	pieces
75052	Metri-Pack™ 280 Tangless Terminal and Seal Kit	425



Scan for pricing or go to www.delcity.net/catalogpricing

Metri-Pack® 280 Sealed Terminal and Seal Kit

The Metri-Pack® 280 kit provides all the essential Metri-Pack® 280 female terminals, seals and cavity plugs. This small kit ensures you have the inventory and is ideal for small projects. Components come in a convenient carrying case (4-1/2"x2-5/8"x1-5/16"). **For a complete listing of kit contents, see page 330.**



part no.	description	pieces
75053	Metri-Pack™ 280 Sealed Terminal and Seal Kit	425

Battery Hardware Kit

Replacing a corroded lug or terminal never seemed so easy! Included in this kit is 5 pieces each of 6 different standard copper lugs 6-2/0 gauge, 5 pieces each of side terminal power accessory, 2 pieces each of universal lead and 6 different copper crimp terminals (8-4/0 gauge). All contained within a rugged, gray metal scoop box (13-5/16" x 9-1/4" x 2"). **For a complete listing of kit contents, see page 328.**



part no.	description	pieces
650	battery hardware kit	49

Solder Pellet & Triple Wall Shrink Tube Battery Kit – The Guardian™

Ensure you have all the necessary accessories for your next battery terminal replacement job. There are 14 different components, including color-coded solder pellets (4 AWG to 4/0 AWG), liquid flux and adhesive-lined, 3:1 shrink tube in both red and black, cut to 1.5" lengths. All items are packaged in a durable, lightweight and translucent carrying case (11" x 6-3/4" x 1-3/4"). **For a complete listing of kit contents, see page 328.**



part no.	description	pieces
652	the Guardian™ battery kit	48

Solder Pellet, Terminals & Triple Wall Shrink Tube Battery Kit – The Terminalator™

This kit contains all the necessary items to repair and seal your battery cable to terminal connections. Twenty-four different items, including battery terminals in 1-2, 1/0 & 2/0 gauge and 3/8", battery terminals in 1-2, 1/0 & 2/0 gauge and 3/8" battery lugs in 4, 2-1, 1/0 & 2/0 gauge with industry standard color coding, solder pellets in 4, 1, 1/0 & 2/0 AWG with industry color coding, liquid flux and 3:1 dual wall adhesive lined black & red shrink tube ranging from 1/2", 3/4" & 1", I.D. in 1.5" cut lengths. All are packaged in a rugged gray metal scoop box (18" x 12" x 3"). **For a complete listing of kit contents, see page 328.**



part no.	description	pieces
654	Terminalator™ battery cable kit	89



kits

Knockout Set

With this knockout set, the four-point design of the punches allow the slugs to drop out of the die automatically without splitting. Perfect for chassis builders, metal fabrication and other OEM/MRO applications. Durable punches make holes in up to 12 gauge stainless steel and 10 gauge mild steel.

part no.	pipe sizes	hole size O.D.	pieces
992100	1/2", 3/4", 1", 1 1/4"	7/8", 1 3/32", 1 1/32", 1 1/16"	6

Ratchet Wrench Knockout Set

The four-point design of the punches allow the slugs to drop out of the die automatically without splitting. Perfect for chassis builders, metal fabrication and other OEM/MRO applications. Durable punches make holes in up to 12 gauge stainless steel and 10 gauge mild steel. Includes a handy ratchet mechanism for application ease. The complete set punches holes from 1/2" to 2".

part no.	pipe sizes	hole size O.D.	pieces
992102	1/2"-2"	7/8"-2 3/8"	9

Brake Line Fitting Kits

These kits are assembled with the most common brake line fittings for both imperial and metric size lines. Kit #12312104 contains 26 pieces and kit #12312158 contains 110 pieces, all within a durable and lightweight plastic carrying case (10-3/4" x 6-3/4" x 1-1/4").

For a complete listing of kit contents, see page 331-332.

part no.	description	pieces
12312104	imperial & metric nut & union assortment	26
12312158	imperial & metric nut & union assortment	110



Scan for pricing or go to www.delcity.net/catalogpricing



12312104

switches

NEW

F-Series: Carling Technologies® Toggle Switches

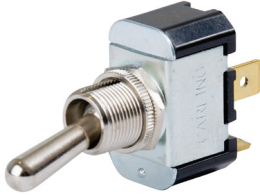

These standard toggle switches are ideal for marine, industrial controls, generators, food service, office automation and other voltage DC rated applications. They feature a slow make and slow break contact mechanism. Switch is manufactured from brass/nickel plate with a phenolic base. The mechanical life of the F-Series is 100,000 cycles, electrical life of 50,000 cycles and a 25,000 cycle maintained, momentary. The dielectric strength meets UL/CSA 1000V, live to dead metal parts. Insulation resistance is 100 megaohms. Temperature rating of 0°F to 150°C (-17.8°C to 65.6°C). Recommended hole: .500"



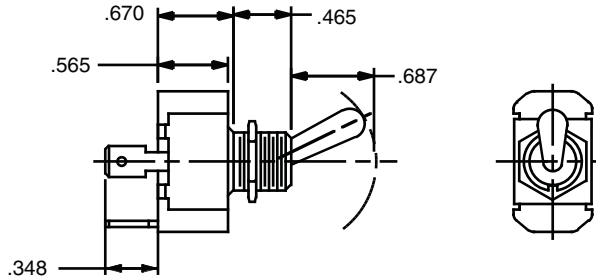

Scan for pricing or go to www.delcity.net/catalogpricing



single pole heavy-duty toggle switches

See above for dimensions

poles	circuit			 .250" Flat	 screw	ratings
	A	B	C	OEM	OEM	
S.P.S.T.	ON	-	OFF	20073020	—	12A 250VAC, 20A 125VAC, 1HP 120-240VAC
S.P.S.T.	ON	-	OFF	—	20073185*	
S.P.S.T.	ON	-	OFF	—	273274DL**	
S.P.S.T.	ON	-	(OFF)	—	27200029*	10A 250VAC, 15A 125VAC, 3/4HP 120-240VAC
S.P.S.T.	(ON)	-	OFF	27200080	—	
S.P.S.T.	(ON)	-	OFF	—	27200018	10A 250VAC, 20A 125VAC, 3/4HP 125-250VAC
S.P.D.T.	ON		ON	27200033	—	
S.P.D.T.	ON		ON	—	27200035	10A 250VAC, 15A 125VAC, 3/4HP 120-240VAC
S.P.D.T.	ON		(ON)	—	27200037	
S.P.D.T.	ON	OFF	ON	20073022	—	10A 250VAC, 15A 125VAC, 3/4HP 250VAC
S.P.D.T.	ON	OFF	ON	27200105	—	10A 250VAC, 20A 125VAC, 3/4HP 125-250VAC
S.P.D.T.	ON	OFF	ON	—	20073115	
S.P.D.T.	ON	OFF	(ON)	27200082	—	10A 250VAC, 15A 125VAC, 3/4HP 120-240VAC
S.P.D.T.	ON	OFF	(ON)	—	27200049	
S.P.D.T.	(ON)	OFF	(ON)	27200045	—	
S.P.D.T.	(ON)	OFF	(ON)	—	20073247	

*Faceplate included.
**Sealed Switch



73100DL



73101

Full Toggle Boots

These tough rubber silicone covers are UV-resistant and protect switches from moisture, dust and dirt. The built-in hex nut base screws onto most toggle switches. Boots are rated for -40°C to 180°C (-40°F to 356°F) and 7900001 meets NEMA 4 requirements.

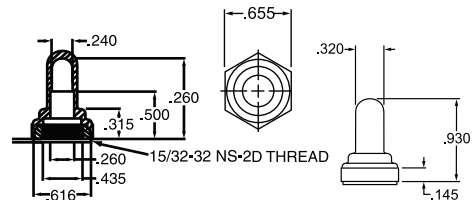

part no.	description	color
73100DL	full toggle boot	black
73101	full toggle boot	clear
7900001*	full toggle boot	black

* UL recognized E60272 component

Call 800.654.4757 for volume pricing and other hardware configurations

switches

NEW

G-Series: Carling Technologies® Toggle Switches



Scan for pricing or go to www.delcity.net/catalogpricing

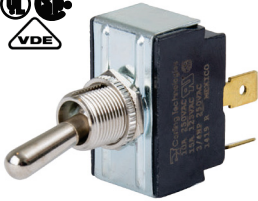

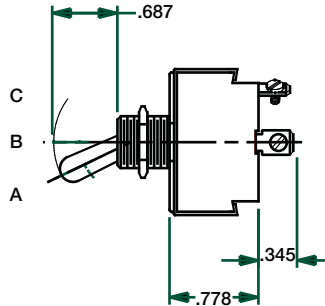
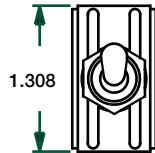

These standard toggle switches are ideal for marine, industrial controls, generators, food service, office automation and other voltage DC rated applications. They feature a slow make and slow break contact mechanism. Switch is manufactured from brass/nickel plate with a phenolic base. The mechanical life of the G-Series is 100,000 cycles, electrical life of 50,000 cycles and a 25,000 cycle maintained, momentary. The dielectric strength meets UL/CSA 1000V, live to dead metal parts and opposite polarity. Insulation resistance is 100 megaohms. Temperature rating of 32°F to 185°C (0°C to 85°C). Recommended hole: .500"



single pole heavy-duty toggle switches

See above for dimensions

poles	circuit			 .250" Flat	 screw	ratings
	A	B	C	OEM	OEM	
D.P.S.T.	ON	-	OFF	27300012		20A 125-277VAC
D.P.S.T.	ON	-	OFF		20073120	
D.P.S.T.	(ON)	-	OFF	27300015		10A 250VAC, 15A 125VAC, 3/4HP 250VAC
D.P.S.T.	(ON)	-	OFF		27300020	
D.P.D.T.	ON	-	ON	27300027		20A 120-277VAC
D.P.D.T.	ON	-	ON		20073246	
D.P.D.T.	ON	-	(ON)		27300033	15A 125VAC, 10A 250VAC, 3/4HP 250VAC
D.P.D.T.	ON	OFF	ON	27300045		
D.P.D.T.	ON	OFF	ON		20073025	20A 120-277VAC
D.P.D.T.	ON	OFF	(ON)	27300103		
D.P.D.T.	ON	OFF	(ON)		27300063	10A 250VAC, 15A 125VAC, 3/4HP 125-250VAC
D.P.D.T.	(ON)	OFF	(ON)	27300050		
D.P.D.T.	(ON)	OFF	(ON)		20073155	10A 250VAC, 15A 125VAC, 3/4HP 250VAC



Toggle Safety Cover

The rugged spring-loaded design of this safety cover provides protection against accidental actuation of a toggle switch. Perfect for a variety of industry applications, from racing to agriculture. Materials: Base faceplate is black steel; cover is colored urea plastic. Mounting hole accepts all standard on-off toggles with 15/32" mounting stems.

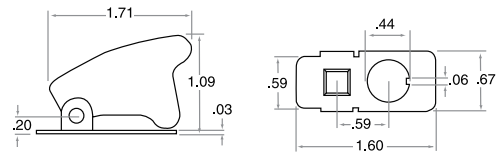

part no.	description	color
73200	toggle safety cover	red
73202	toggle safety cover	brite red
73203	toggle safety cover	black
73500	toggle safety cover	chrome red
73501	toggle safety cover	chrome blue

Call 800.654.4757 for volume pricing and other hardware configurations

switches

Single Pole Heavy-duty Toggle Switches

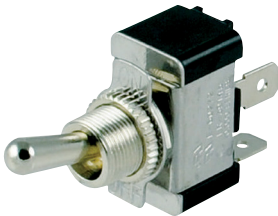

Standard, heavy-duty switches are ideal for industrial controls, marine panels, trucks, buses and automotive applications. The "O" ring toggle switches feature a neoprene gasket at the base of the actuator to prevent dust and moisture from interrupting the actuation and protecting against harsh environments. The frame and supports are manufactured from a zinc chromate plated steel with a black phenolic plastic case (flammability rating: UL 94 flame class 94V-1). Terminals are made from brass material with all other exterior parts being brass/bright nickel. **Recommended mounting hole: .500" diameter.**



Scan for pricing or go to www.delcity.net/catalogpricing

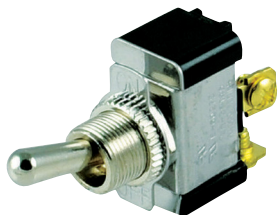

Hardware included
Knurl nut, hex nut, On-Off faceplate (faceplate not included on double pole switches)

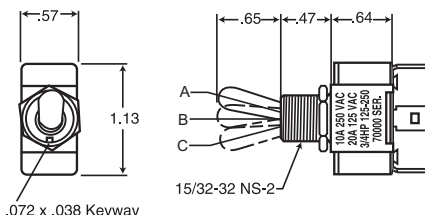

OEM
back-up nut assembled only, other hardware poly bagged

Assembled
all hardware assembled on switch





Note: All toggles must be installed with a hex nut (provided) behind panel to prevent damage during installation.

single pole heavy-duty toggle switches

See above for dimensions										
poles	circuit			.250" Flat		screw		reg. solder		ratings
	A	B	C	OEM	assembled	OEM	assembled	OEM	assembled	
S.P.S.T.	ON	—	OFF	7200012*	73020	7200017	73185	7200020	7200019*	10A @ 277V AC 20A @ 125V AC 21A @ 14V DC 3/4 HP 125-250V AC
S.P.S.T.	(ON)	—	OFF	—	7200080	—	7200018	—	—	
S.P.S.T.	ON	—	(OFF)	—	—	—	7200029	—	—	
S.P.D.T.	ON	—	ON	—	7200033*	—	7200035*	7200039	—	
S.P.D.T.	ON	—	(ON)	—	—	—	7200037*	—	—	
S.P.D.T.	ON	OFF	ON	7200044*	73022*	—	73115*	7200052*	—	
S.P.D.T.	ON	OFF	(ON)	—	7200082	—	7200049*	—	—	
S.P.D.T.	(ON)	OFF	(ON)	7200047*	7200045*	—	73247*	7200054*	—	

() Indicates momentary action
* Does not include faceplate

single pole heavy-duty "o" ring toggle switches

See above for dimensions										
poles	circuit			.250" Flat		screw		reg. solder		ratings
	A	B	C	OEM	assembled	OEM	assembled	OEM	assembled	
S.P.S.T.	ON	—	OFF	7200004	7200102	—	73274DL	—	—	10A @ 277V AC 20A @ 125V AC 21A @ 14V DC 3/4 HP 125-250V AC
S.P.S.T.	(ON)	—	OFF	—	7200101	—	7200100	—	—	
S.P.D.T.	ON	—	ON	—	—	—	7200103*	—	—	
S.P.D.T.	ON	OFF	ON	—	7200105*	—	7200104*	—	—	
S.P.D.T.	(ON)	OFF	(ON)	7200084*	7200107*	—	7200106*	—	—	

() Indicates momentary action
* Does not include faceplate

INFORMATION

SWITCH TYPES:

S.P.S.T. = single pole, single throw - switches control a single wire circuit.
S.P.D.T. = single pole, double throw - switches control two single wire circuits, permitting only one circuit to be energized at a time.

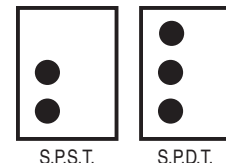

Call 800.654.4757 for volume pricing and other hardware configurations

switches

Double Pole Heavy-duty Toggle Switches

Standard, heavy-duty switches are ideal for industrial controls, marine panels, trucks, buses and automotive applications. The "O" ring toggle switches feature a neoprene gasket at the base of the actuator to prevent dust and moisture from interrupting the actuation and protecting against harsh environments. The frame and supports are manufactured from a zinc chromate plated steel, with a black phenolic plastic case (flammability rating: UL 94 flame class 94V-1). Terminals are made from brass material with all other exterior parts being brass/bright nickel. **Recommended mounting hole: .500" diameter.**



Scan for pricing or go to www.delcity.net/catalogpricing

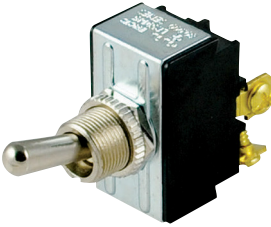
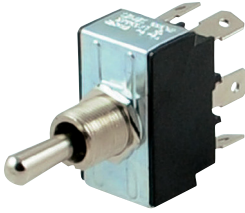

Hardware included
Knurl nut, hex nut, On-Off faceplate (faceplate not included on double pole switches)

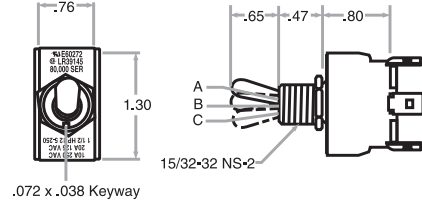

OEM
Back-up nut assembled only, other hardware poly bagged

Assembled
All hardware assembled on switch





Note: All toggles must be installed with a hex nut (provided) behind panel to prevent damage during installation.

double pole heavy-duty toggle switches

See for dimensions										
poles	circuit			.250" Flat		screw		reg. solder		ratings
	A	B	C	OEM	assembled	OEM	assembled	OEM	assembled	
D.P.S.T.	ON	—	OFF	7300013	7300012	7300018	73120	—	7300022	10A @ 277V AC 20A @ 125V AC 21A @ 14V DC 1½ HP 125–250V AC
D.P.S.T.	(ON)	—	OFF	—	7300015	—	7300020	—	—	
D.P.D.T.	ON	—	ON	7300028*	7300027*	—	73246*	7300037*	—	
D.P.D.T.	ON	—	(ON)	7300029*	—	—	7300033*	—	—	
D.P.D.T.	ON	OFF	ON	7300047*	7300045*	—	73025*	7300068*	—	
D.P.D.T.	ON	OFF	(ON)	—	7300103*	—	7300063*	—	—	
D.P.D.T.	(ON)	OFF	(ON)	7300051*	7300050*	—	73155*	—	—	

() Indicates momentary action
* Does not include faceplate

double pole heavy-duty "o" ring toggle switches

See for dimensions										
poles	circuit			.250" Flat		screw		reg. solder		ratings
	A	B	C	OEM	assembled	OEM	assembled	OEM	assembled	
D.P.S.T.	ON	—	OFF	—	7300126	—	7300125	—	—	10A @ 277V AC 20A @ 125V AC 21A @ 14V DC 1½ HP 125–250V AC
D.P.D.T.	ON	—	ON	—	7300128*	—	—	—	—	
D.P.D.T.	ON	OFF	ON	—	7300131*	—	7300129*	—	—	
D.P.D.T.	(ON)	OFF	(ON)	—	7300135*	—	7300133*	—	—	

() Indicates momentary action
* Does not include faceplate

INFORMATION

SWITCH TYPES:

D.P.S.T. = double pole, single throw - switches control two circuits simultaneously. Circuits are ON at the same time, OFF at the same time and may be of different voltages from separate sources.

D.P.D.T. = double pole, double throw - switches control four circuits, permitting only two circuits to be energized at a time.

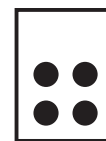

D.P.S.T.



D.P.D.T.

Call 800.654.4757 for volume pricing and other hardware configurations

switches

Specialty Circuit, Heavy-duty Toggle Switches

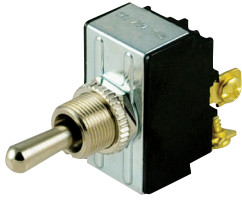

Choose from a complete line of heavy-duty, motor-rated, reversing and progressive toggle switches. Typical applications include: tailgate, lift platform, motor controls and general industrial automation applications. The frame and supports are manufactured from zinc chromate plated steel, with a black phenolic plastic case (flammability rating: UL 94 flame class 94V-1). Terminals are made from brass material with all other exterior parts being brass/bright nickel. Available in a complete line of actuation and termination styles. **Recommended mounting hole: .500" diameter.**



Scan for pricing or go to www.delcity.net/catalogpricing

Figure 1

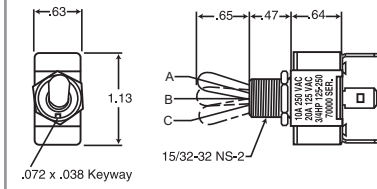
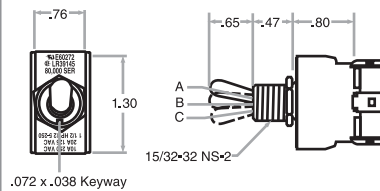

Figure 2



Hardware included

Knurl nut, hex nut, 7200001 & 7200002 comes with hex nut, knurl nut and On-Off faceplate

OEM

Back-up nut assembled only, other hardware poly bagged

Assembled

All hardware assembled on switch

Note: All toggles must be installed with a hex nut (provided) behind panel to prevent damage during installation.

motor-rated heavy-duty toggle switches

Refer to Figure 1 & 2 above for dimensions

poles	circuit			.250" Flat		screw		figure	ratings
	A	B	C	OEM	assembled	OEM	assembled		
S.P.S.T.	ON	—	OFF	7200002	—	7200001	—	1	10A 250V AC 20A 125V AC 3/4 HP 125–250V AC
D.P.S.T.	ON	—	OFF	7300001*	—	7300021*	—	2	20A @ 277V AC 1-1/2 HP @ 125–250V AC
D.P.D.T.	ON	—	ON	7300002*	—	—	—	2	

* Does not include faceplate

Figure 3

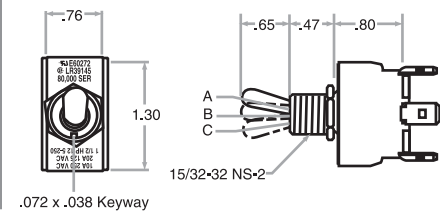
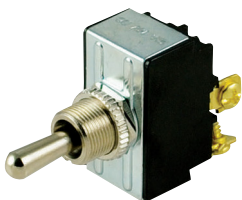

Hardware included

Knurl nut, hex nut

OEM

Back-up nut assembled only, other hardware poly bagged

Assembled

All hardware assembled on switch

reversing and progressive toggle switches

Refer to Figure 3 above for dimensions

poles	style	circuit			part no.	termination		no. of terminals	ratings
		A	B	C		OEM	assembled		
S.P.3.T	progressive	ON	ON	ON	7300048	—	.250 flat	5	10A @ 277V AC 20A @ 125V AC 1-1/2 HP @ 125–250V AC
D.P.D.T.	reversing	ON	OFF	ON	7300054	.250 flat	—	6	
D.P.D.T.	reversing	(ON)	OFF	(ON)	7300055	—	.250 flat	4	
D.P.D.T.	reversing	ON	—	ON	7300038	—	screw	6	21A @ 14V DC
D.P.D.T.	reversing	(ON)	OFF	(ON)	7300057	—	.250 flat	4	
D.P.D.T.	reversing	(ON)	OFF	(ON)	7300067	—	screw	4	

() indicates momentary action

Call 800.654.4757 for volume pricing and other hardware configurations



Scan for pricing or go to www.delcity.net/catalogpricing

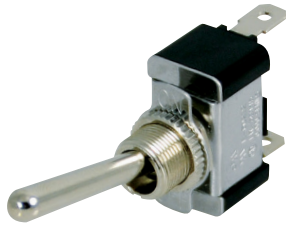

switches

Specialty Toggle Bat Handle Switches

These standard, heavy-duty switches feature an extended bat handle. They are ideal for industrial controls, marine panels, trucks, buses and automotive applications. The frame and support are manufactured from a zinc chromate plated steel, with a black phenolic plastic case (flammability rating: UL 94 flame class 94V-1). Terminals are made from a brass material with all other exterior parts being brass/bright nickel. **Recommended mounting hole: .500" diameter.**

Figure 1

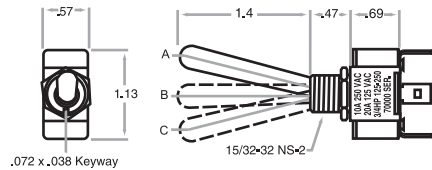

Hardware included
Knurl nut, hex nut, On-Off faceplate

OEM
Back-up nut assembled only, other hardware poly bagged

Assembled
All hardware assembled on switch

Note: All toggles must be installed with a hex nut (provided) behind panel to prevent damage during installation.

double pole heavy-duty toggle switch

Refer to **Figure 1** above for dimensions

poles	circuit			.250" Flat		screw		reg. solder		ratings
	A	B	C	OEM	assembled	OEM	assembled	OEM	assembled	
S.P.S.T.	ON	—	OFF	—	—	—	7200032	—	—	10A @ 277V AC 20A @ 125V AC 3/4 HP 125–250V AC

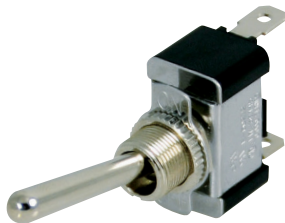
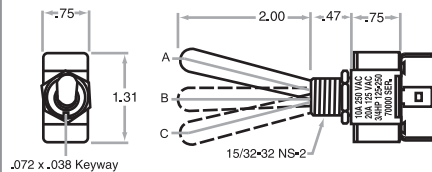

Figure 2



Hardware included
Knurl nut, hex nut

OEM
Back-up nut assembled only, other hardware poly bagged

Assembled
All hardware assembled on switch

Note: All toggles must be installed with a hex nut (provided) behind panel to prevent damage during installation.

double pole heavy-duty toggle switch

Refer to **Figure 2** above for dimensions

poles	circuit			.250" Flat		screw		reg. solder		ratings
	A	B	C	OEM	assembled	OEM	assembled	OEM	assembled	
D.P.D.T. (ON)	OFF	(ON)		—	7900081	—	—	—	—	10A @ 277V AC 20A @ 125V AC 1½ HP 125–250V AC

() Indicates momentary action

Call 800.654.4757 for volume pricing and other hardware configurations

switches

On-Off Faceplate & Locating Ring

This ON-OFF faceplate is a replacement for standard on-off switches. The keyway nub locks and orientates faceplate in proper position. The locating ring is used as an orientation point for the key slot on a toggle switch. Designed for 15/32" bushing.



faceplate

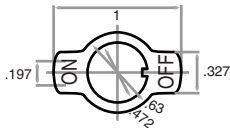

locating ring

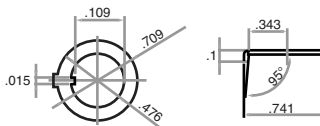

part no.	description
7900014	ON-OFF faceplate
7900016	locating ring



Scan for pricing or go to www.delcity.net/catalogpricing



73100DL



73101

Full Toggle Boots

These tough rubber silicone covers are UV-resistant and protect switches from moisture, dust and dirt. The built-in hex nut base screws onto most toggle switches. Boots are rated for -40°C to 180°C (-40°F to 356°F) and 7900001 meets NEMA 4 requirements.

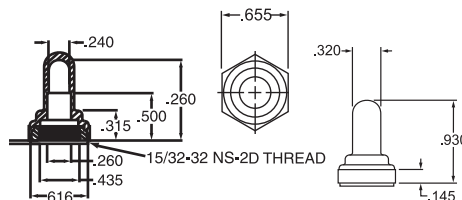

part no.	description	color
73100DL	full toggle boot	black
73101	full toggle boot	clear
7900001*	full toggle boot	black

* UL recognized E60272 component



Half Toggle Boot

This tough rubber silicone cover is UV-resistant and provides protection from moisture, dust and dirt. The half boot opening slips tightly over most standard toggle handles and is secured by a hex nut molded into the base. Rated for -40°C to 180°C (-40°F to 356°F).

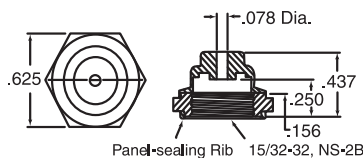

part no.	description
7900003	half toggle boot

switches

Toggle Safety Cover

The rugged spring-loaded design of this safety cover provides protection against accidental actuation of a toggle switch. Perfect for a variety of industry applications, from racing to agriculture. Materials: Base faceplate is black steel; cover is colored urea plastic. Mounting hole accepts all standard on-off toggles with 15/32" mounting stems.

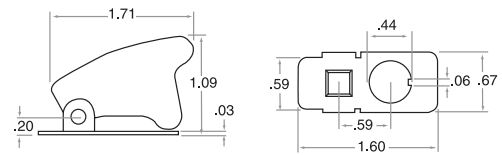

part no.	description	color
73200	toggle safety cover	red
73202	toggle safety cover	brite red
73203	toggle safety cover	black
73500	toggle safety cover	chrome red
73501	toggle safety cover	chrome blue

Toggle Switch & Red Safety Cover Kit

This kit includes one each of the standard On-Off toggle switch (part number 73185 – see page 90 for ratings) and toggle safety cover (part number 73200; see above). The toggle safety cover is red urea plastic with a black steel faceplate. The kit arrives unassembled and polybagged.

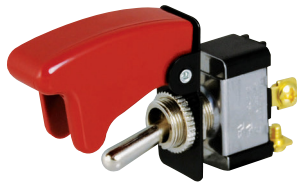

part no.	description
73210	toggle switch & red safety cover kit

Toggle Safety Panel

Protect your toggle switches from accidental actuation. The chrome bars provide an aesthetically pleasing look and allow for up to 3 switches with up to 1" bat handles to be mounted. Each slot features a keyway notch for easy and proper installation. Flush mounting is made easy with two #4 screw holes. **Dimensions: 4 1/16" L x 2" H x 2" D.**



part no.	description	color
7400300	3-way toggle panel	black/chrome

Hi-Amp Toggle Switches

Ideal for low-voltage, hi-amp applications. Choose from three different toggle handle colors and wire connection styles. The housing is die cast, with silver plated contacts and heavy copper terminals. The switches are designed for long life with a 50,000 electrical life cycle and 100,000 mechanical life cycle. **Recommended mounting hole: .500" diameter.**

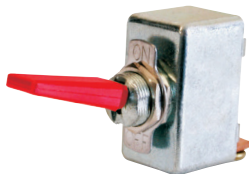

73242



73240

single pole hi-amp toggle switches

poles	circuit			termination	handle color	ratings
	A	B	C	screw		
S.P.S.T.	ON	—	OFF	73240DL	black	50A @ 12V DC
S.P.S.T.	ON	—	OFF	73242DL	red	
S.P.S.T.	ON	—	OFF	73245	chrome	



Call 800.654.4757 for volume pricing and other hardware configurations



Scan for pricing or go to www.delcity.net/catalogpricing



switches

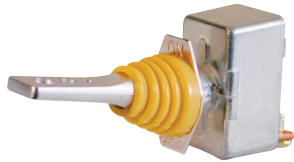

Hi-Amp Toggle Switch with Interchangeable Boot RoHS

Ideal for low-voltage, hi-amp applications. This switch includes 4 different color (black, blue, red and yellow) interchangeable boots. The housing is die cast, with silver plated contacts and heavy copper terminals. This switch is designed for long life with a 50,000 electrical life cycle and 100,000 mechanical life cycle. **Recommended mounting hole: .500" diameter.**



Scan for pricing or go to www.delcity.net/catalogpricing

single pole hi-amp toggle switch

poles	circuit			termination		handle color	ratings
	A	B	C	.250" flat	screw		
S.P.S.T.	ON	—	OFF	—	73244	chrome	50A @ 12V DC

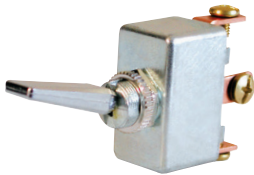

Hi-Amp Toggle Switch with Chrome Wedge Handle RoHS

Ideal for low-voltage, hi-amp applications. The housing is die cast, with silver plated contacts and heavy copper terminals. This switch is designed for long life with a 50,000 electrical life cycle and 100,000 mechanical life cycle. **Recommended mounting hole: .500" diameter.**

single pole hi-amp toggle switch

poles	circuit			termination		handle color	ratings
	A	B	C	.250" flat	screw		
S.P.D.T.	ON	OFF	ON	—	73265	chrome	50A @ 12V DC

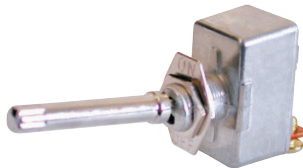

Hi-Amp Toggle Switch with Extended Handle RoHS

Ideal for low-voltage, hi-amp applications. Features a 15/8" bat handle for easy actuation. The housing is die cast, with silver plated contacts and heavy copper terminals. It's designed for long life with a 50,000 electrical life cycle and 100,000 mechanical life cycle. **Recommended mounting hole: .500" diameter.**

single pole hi-amp toggle switch

poles	circuit			termination		handle color	ratings
	A	B	C	.250" flat	screw		
S.P.S.T.	ON	—	OFF	—	73260	chrome	50A @ 12V DC

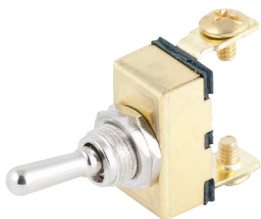

Brass Toggle Switch RoHS

Ideal for marine applications, the housing is manufactured from all brass material, with copper rivets for optimum conductivity. Furnished with nickel-plated face plate and brass back-up nut. Mounting stem dimensions: 3/8"L x 7/16"D, 1/16" x 28 threading. **Recommended mounting hole: .438" diameter.**

single pole toggle switch

poles	circuit			termination		handle color	ratings
	A	B	C	.250" flat	screw		
S.P.S.T.	ON	—	OFF	—	73275DL	chrome	35A @ 6V DC 20A @ 12V DC

Call 800.654.4757 for volume pricing and other hardware configurations



Scan for pricing or go to www.delcity.net/catalogpricing

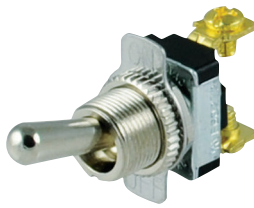

switches

Medium-duty Toggle Switches

These medium-duty toggles are durable and compactly designed for applications where space may be a constraint. Ideal for small appliances, floor maintenance and control units. The frame and support are manufactured from zinc chromate, plated steel, with a black, phenolic plastic case (flammability rating: UL 94 flame class 94V-1). Terminals are made from brass with all other exterior parts being brass/bright nickel.

Recommended mounting hole: .500" diameter.

Figure 1

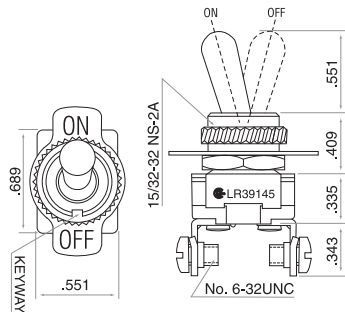

3A/250V AC
6A/125V AC

Figure 2

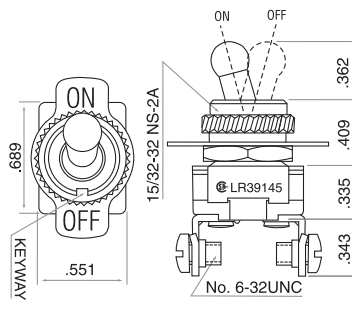

3A/250V AC
6A/125V AC

Figure 3

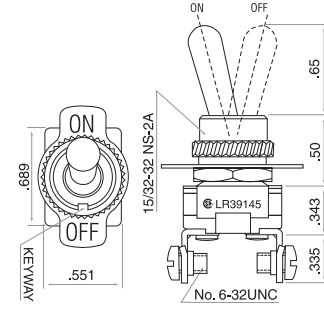

10A/250V AC
15A/125V AC

Figure 4

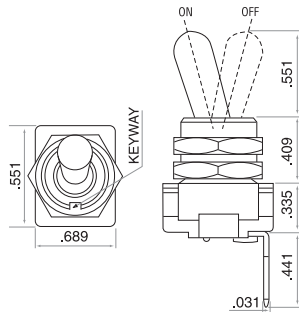

21A/14V DC

Figure 5

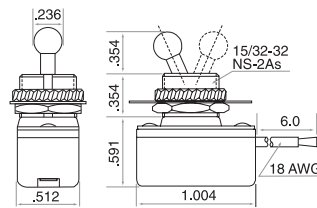

3A/250V AC
6A/125V AC

Figure 6

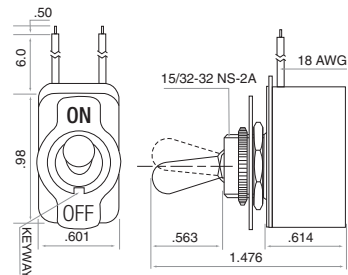

4A/250V AC
8A/125V AC

single pole medium-duty toggle switches

Refer to drawings above for dimensions

poles	circuit			dimensions			figure	ratings
	A	B	C	.250" Flat	screw	leaded		
S.P.S.T.	ON	—	OFF	—	73030	—	1	3A @ 240V AC, 6A @ 120V AC
S.P.S.T.	ON	—	OFF	—	—	73105	6	4A @ 250V AC, 8A @ 125V AC
S.P.S.T.	ON	—	OFF	—	73190	—	3	10A @ 240V AC, 15A @ 120V AC
S.P.S.T.	ON	—	GRD	790009	—	—	4	21A @ 14V DC
S.P.S.T.	ON	—	OFF	—	—	7900010*	5	3A @ 250V AC, 6A @ 125V AC
S.P.S.T.	ON	—	OFF	—	7900007*	—	2	3A @ 250V AC, 6A @ 125V AC

* ball toggle

Call 800.654.4757 for volume pricing and other hardware configurations

switches

Double Insulated, Plastic Toggle Switches

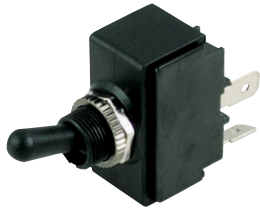

Choose from both standard and wedge handle versions of this versatile toggle switch. Both include an internal "O" ring for resistance to moisture and other foreign debris. The double insulation makes this switch ideal for marine panels, automotive, recreation, equipment, industrial controls, trucks, buses and other weather-resistant applications. Frame and toggle handle are manufactured from a black, phenolic plastic (flammability rating: UL 94 flame class 94V-1). Terminals are a brass material with all other exterior parts made of brass/bright nickel. **Recommended mounting hole: .500" diameter.**



Scan for pricing or go to www.delcity.net/catalogpricing

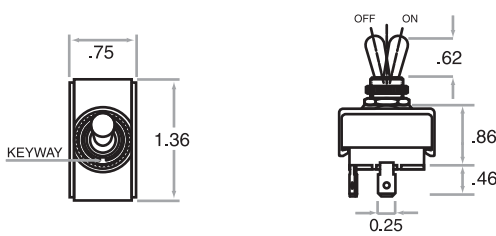

Hardware included
Black knurl nut, hex nut



OEM
Back-up nut assembled only, other hardware poly bagged

Assembled
All hardware assembled on switch

Note: All toggles must be installed with a hex nut (provided) behind panel to prevent damage during installation.

non-illuminated single pole double insulated toggles

See above for dimensions

poles	circuit					ratings
	A	B	C	assembled	assembled	
S.P.S.T.	ON	—	OFF	7000012	73305	10A @ 277V AC 20A @ 125V AC 21A @ 14V DC
S.P.D.T.	ON	—	ON	7000018	—	
S.P.D.T.	ON	—	(ON)	7000019	—	
S.P.D.T.	ON	OFF	ON	7000024	7000022	
S.P.D.T.	(ON)	OFF	(ON)	7000026	7000023	
D.P.S.T.	ON	—	OFF	7000030	—	
D.P.D.T.	ON	—	ON	—	7000054	
D.P.D.T.	ON	OFF	ON	7000042	73150	
D.P.D.T.	(ON)	OFF	(ON)	7000044*	73160	

() Indicates momentary action



6-way Toggle Switch Panel

This IP 56 rated switch panel provides a spray-proof and aesthetically pleasing way to control up to 6 different mechanisms. The included toggle boots provide protection of the S.P.S.T., ON-OFF switch from harsh environments. Each switch is prewired with ATC®/ATO® fuse and fuse holder. **Switch panel dimensions: 3.75"H x 4.25"W x 2.90"D.**

non-illuminated single pole toggle switch panel

poles	circuit			description	ratings
	A	B	C		
S.P.S.T.	ON	—	OFF	7200400	6 x 15A @ 12V DC

Call 800.654.4757 for volume pricing and other hardware configurations



Scan for pricing or go to www.delcity.net/catalogpricing



7900065



7000007

INFORMATION

Illumination:
Independent vs. dependant

Dependant – Switch will illuminate when actuated to ON position.

Independent – Switch will illuminate as long as power is supplied to the switch

switches

Light-duty Toggle Switches RoHS

These light-duty toggle switches are ideal for almost any application. An internal "O" ring helps seal out dust, moisture and other foreign debris. Available in both dependant and independent illumination. **Recommended mounting hole: .500" diameter.**

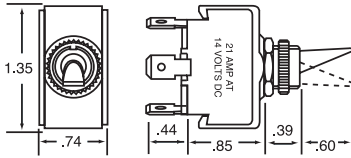

Hardware included
Black knurl nut, black hex nut

Assembled
All hardware assembled on switch

Note: All toggles must be installed with a hex nut (provided) behind panel to prevent damage during installation.

illuminated single pole light-duty toggle switches

See above for dimensions

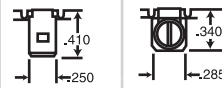

poles	circuit			illumination	ratings
	A	B	C		
S.P.S.T.	ON	—	OFF	7900065	red/dep, white/indep
S.P.S.T.	ON	—	OFF	7000007	red/dep, white/indep
S.P.S.T.	ON	—	OFF	7200025	red/dep

21A @ 14V DC



71015



71510

LED Illuminated Toggle Switches with Chrome Handle RoHS

Choose from either standard or extended bat handle (1 1/32"). Both incorporate a chrome handle and LED light with a 100,000 hour life. Wiring is made simple with labeled .250" terminals. Housing is manufactured from a polycarbonate material. **Recommended mounting hole: .500" diameter.**

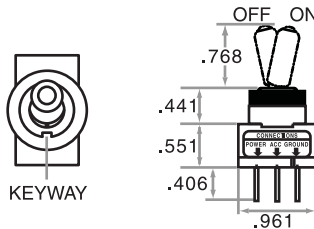

Hardware included
Black hex nut

Assembled
All hardware assembled on switch

illuminated single pole light-duty toggle switches

See above for dimensions

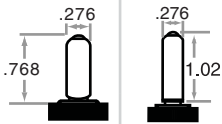

poles	circuit			illumination	ratings	
	A	B	C			
S.P.S.T.	ON	—	OFF	71000	71500	red
S.P.S.T.	ON	—	OFF	71005	71505	amber
S.P.S.T.	ON	—	OFF	71010	71510	blue
S.P.S.T.	ON	—	OFF	71015	71515	green

20A @ 12V DC

Call 800.654.4757 for volume pricing and other hardware configurations

switches

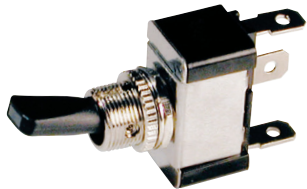

LED Illuminated Toggle Switches with Wedge Handle

Perfect for automotive use. The square tip illuminated LED provides vibrant illumination. Minimum draw requirement for the LED is 20mA at 12V DC. Wire hook-up is made easy by utilizing a standard .250" terminal. Includes knurl nut.

Recommended mounting hole: .500" diameter.



Scan for pricing or go to www.delcity.net/catalogpricing

LED illuminated single pole toggle switches

poles	circuit			termination	illumination	ratings
	A	B	C	.250 flat		
S.P.S.T.	ON	—	OFF		red	30A @ 12V DC
S.P.S.T.	ON	—	OFF	73050	green	
S.P.S.T.	ON	—	OFF	73060	blue	
S.P.S.T.	ON	—	OFF	73065	white	



LED Toggle Switch with Full Tip Illumination

Perfect for automotive use. The full tip illumination of the LED provides vibrant illumination when actuated. Minimum draw requirement for the LED is 20mA at 12V DC. Housing is manufactured from a polycarbonate material with brass terminals. Wire hook-up is made easy by utilizing a standard .250" terminal. The length of the toggle is .966". Includes knurl nut.

Recommended mounting hole: .500" diameter.

LED illuminated single pole toggle switch

poles	circuit			termination	illumination	ratings
	A	B	C	.250 flat		
S.P.S.T.	ON	—	OFF		red	20A @ 12V DC
				73180		



76005

LED Toggle Switches with Full Handle Illumination

The translucent colored handle gently glows from a 100,000 hour LED when actuated. The 1" handle allows for easy viewing and actuation. Housing is manufactured from a polycarbonate material with brass terminals. Wire hook-up is made easy by utilizing a standard .250" terminal. Includes knurl nut.

Recommended mounting hole: .500" diameter.

LED illuminated single pole toggle switches

poles	circuit			termination	illumination	ratings
	A	B	C	.250 flat		
S.P.S.T.	ON	—	OFF		red	20A @ 12V DC
				76000		



Scan for pricing or go to www.delcity.net/catalogpricing



73205



73145

switches

Illuminated Toggle Switches with Extended Duckbill Handle

The translucent colored wedge handle gently glows from an incandescent bulb when actuated. The .687" handle allows for easy viewing and actuation. Housing is manufactured from a polycarbonate material with brass terminals. Wire hook-up is made easy by utilizing a standard .250" terminal. Includes knurl nut. **Recommended mounting hole: .500" diameter.**

illuminated single pole toggle switches

poles	circuit			termination	illumination	ratings
	A	B	C	.250 flat		
S.P.S.T.	ON	—	OFF		73205	20A @ 12V DC
S.P.S.T.	ON	—	OFF	73215	red	
S.P.S.T.	ON	—	OFF	73225	green	
S.P.S.T.	ON	—	OFF	73235	amber	
S.P.S.T.	ON	—	OFF	73145*	blue	
S.P.S.T.	ON	—	OFF		73145*	black

* Non-illuminated



76900

LED Illuminated Duckbill Toggle Switches

The translucent colored handle gently glows from a 100,000 hour LED when actuated. The .625" handle allows for easy viewing and actuation. Housing is manufactured from a polycarbonate material with brass terminals. Wire hook-up is made easy by utilizing a standard .250" terminal. Includes knurl nut. **Recommended mounting hole: .500" diameter.**

LED illuminated single pole toggle switches

poles	circuit			termination	illumination	ratings
	A	B	C	.250 flat		
S.P.S.T.	ON	—	OFF		76900	20A @ 12V DC
S.P.S.T.	ON	—	OFF		red	



73176



73170



73172

Illuminated Duckbill Toggle Switches

The translucent colored, duck-billed handle gently glows from an incandescent bulb when actuated. The .625" handle allows for easy viewing and actuation. Housing is manufactured from a polycarbonate material with brass terminals. Wire hook-up is made easy by utilizing a standard .250" terminal. Includes knurl nut.

Recommended mounting hole: .500" diameter.

illuminated single pole toggle switches

poles	circuit			termination	illumination	ratings
	A	B	C	.250 flat		
S.P.S.T.	ON	—	OFF		73174DL	20A @ 12V DC
S.P.S.T.	ON	—	OFF		73176	
S.P.S.T.	ON	—	OFF		73178	
S.P.S.T.	ON	—	OFF		73179	
S.P.S.T.	ON	—	OFF		73170DL*	
S.P.S.T.	ON	—	OFF		73172DL*	

* Non-illuminated

Call 800.654.4757 for volume pricing and other hardware configurations

switches

Modular Panels



Allows for mixing and matching of any combination of switches and indicator lamps. Simply use the provided snap-in clips to connect multiple panels together. No tools necessary. Use 73575 with switches: 73355DL, 73365, 73375 and 73385 (see page 118). Use 73585 with switches: 71000, 71005, 71010, 71015 (see page 109) and any other .500" mounting stem switch.



Scan for pricing or go to www.delcity.net/catalogpricing

part no.	description
73575	modular panel for 1/2" x 1" rectangular hole mounted switches
73585	modular panel for 1/2" circular hole mounted switches



7600500

LED Illuminated Paddle Switches

Unique design allows for a greater surface area of actuator to be used. The square tip LED provides a vibrant illumination when actuated. Housing is manufactured from black nylon and easily snaps into place. **Recommended mounting hole: .866" diameter.**

LED illuminated single pole paddle switches

poles	circuit			termination	number of terminals	illumination	ratings
	A	B	C	.250" flat			
S.P.S.T.	ON	—	OFF		4	red	20A @ 12V DC
S.P.S.T.	ON	—	OFF	7600500*	4	green	

* contains two additional solder terminals



Crimp & Shrink Terminal Assortment Kit with Tools – The Tanker™

All of the ammunition you need to get the job done. This kit contains ring terminals, butt connectors, push-on terminals, a crimping tool and a heat gun. Self-sealing heat shrink terminals are UL listed. All items are contained within a rugged gray metal scoop box (18" x 12" x 3"). **For a complete listing of kit contents, see page 325.**

part no.	description	pieces
277	Tanker™ shrink tube terminal kit	282



Crimp, Shrink & Solder Terminal Assortment Kit – The MegaMaxxx™

This kit features the ultimate terminals – shrink tube, solder sleeve and crimpable connectors. It contains 12 different terminals designed to provide an array of connecting options for both small and large jobs. All contained within a rugged gray metal box (18" x 12" x 3"). **For a complete listing of kit contents, see page 325.**

part no.	description	pieces
278	Megamaxxx™ performance terminal kit	200

Call 800.654.4757 for volume pricing and other hardware configurations



Scan for pricing or go to www.delcity.net/catalogpricing



7700061



73392

switches

Full Size Rocker Switches

This heavy-duty, full size rocker switch is versatile enough for numerous applications. Rocker frame and actuator are manufactured from glass-filled nylon, with the case molded from black nylon (flammability rating: UL 94 flame class 94V-2). Terminals are manufactured from brass material. A secondary gasket is molded into the switch base to provide added moisture and dust resistance. These switches are ideal for commercial applications, motor controls, trucks, buses, van conversions, marine panels and automotive applications.

Recommended mounting hole: .830" (+ 0.015) x 1.450" (+ .005).

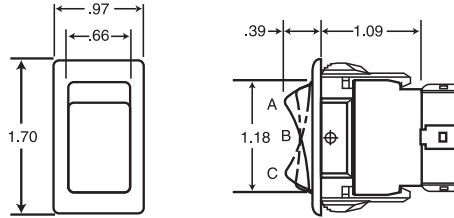

non-illuminated single & double pole rocker switches

See above for dimensions

poles	circuit			rocker color or description	termination		ratings
	A	B	C		.250" flat	screw	
S.P.S.T.	ON	—	OFF	black/black	73391	—	10A @ 277V AC 20A @ 125V AC 3/4 HP 125–250V AC
S.P.S.T.	ON	—	OFF	black/ I O	7700061	—	
S.P.S.T.	(ON)	—	OFF	black/black	7700003	—	
S.P.D.T.	ON	—	ON	black/black	7700018	—	
S.P.D.T.	ON	OFF	ON	black/black	7700028	—	
S.P.D.T.	(ON)	OFF	(ON)	black/black	7700030	—	
D.P.S.T.	ON	—	OFF	black/black	73392	—	10A @ 277V AC 20A @ 125V AC 1-1/2 HP 125–250V AC
D.P.D.T.	ON	—	ON	black/black	7700024	—	
D.P.D.T.	ON	OFF	ON	black/black	7700044	—	
D.P.D.T.	ON	OFF	(ON)	black/black	7700045	—	
D.P.D.T.	(ON)	OFF	(ON)	black/black	7700046*	7700050	

() Indicates momentary action

* 7700046 also available with reversing function 7700061



7700007

illuminated single pole rocker switches

See above for dimensions

poles	circuit			rocker color or description	termination		ratings
	A	B	C		.250" flat	screw	
S.P.S.T.	ON	—	OFF	black/red dot	7700007	—	21A @ 14V DC
S.P.S.T.	ON	—	OFF	black/red dot	—	73393	
S.P.S.T.	ON	—	OFF	black/green dot	—	73394	
S.P.S.T.	ON	—	OFF	black/amber dot	—	73395	

Call 800.654.4757 for volume pricing and other hardware configurations

switches

Euro-Style Full Size Rocker Switches

The wave-like actuator provides a sleek appearance to any application. These switches are water and dust resistant, rated to IP56 NEMA. The nylon 6/6 actuator and frame are designed with a drainage system to help funnel water away from the internal switch components.

Recommended mounting hole: .830" (+ 0.015) x 1.450" (+ .005).



7700300



Scan for pricing or go to www.delcity.net/catalogpricing

non-illuminated single pole rocker switches

poles	circuit			rocker color or description	termination	number of terminals	ratings
	A	B	C		.250" flat		
S.P.S.T.	ON	—	OFF	black/black		2	16A @ 125V AC 10A @ 277V AC 3/4 HP 125–277V AC 21A @ 14V DC
S.P.S.T.	(ON)	—	OFF	black/black	7700301	2	
S.P.D.T.	ON	—	ON	black/black	7700302	3	
S.P.S.T.	ON	OFF	ON	black/black	7700303	3	
S.P.D.T.	ON	OFF	(ON)	black/black	7700304	3	
S.P.D.T.	(ON)	OFF	(ON)	black/black	7700305	3	
D.P.S.T.	ON	—	OFF	black/black	7700320	4	
D.P.S.T.	(ON)	—	OFF	black/black	7700321	4	
D.P.D.T.	ON	—	ON	black/black	7700322	6	
D.P.D.T.	ON	OFF	ON	black/black	7700323	6	
D.P.D.T.	ON	OFF	(ON)	black/black	7700324	6	
D.P.D.T.	(ON)	OFF	(ON)	black/black	7700325	6	



7700400

LED illuminated single pole rocker switches

poles	circuit			rocker color or description	termination	number of terminals	ratings
	A	B	C		.250" flat		
S.P.S.T.	ON	—	OFF	black/red dot		3	20A @ 12V DC
S.P.S.T.	ON	—	OFF	black/amber dot	7700401	3	
S.P.S.T.	ON	—	OFF	black/blue dot	7700403	3	
S.P.S.T.	ON	—	OFF	black/white dot	7700404	3	

Call 800.654.4757 for volume pricing and other hardware configurations

NEW

V-Series Carling Technologies® Contura III Rocker Switches



Scan for pricing or go to www.delcity.net/catalogpricing



Carling Contura III rocker switches are manufactured to the highest standards for the demanding marine and transportation industries. They are designed to last 50,000 to 100,000 electrical cycles and fully tested to environmental, corrosion, temperature, vibration, shock and sealing tests. Any environment, every time. MIL-Std 202F, MIL-Std 810C, UL 1500/ISO8846, IEC 60529, BS 5490, UV940 flammability rating for switch base.
Recommended mounting hole: 0.830" x 1.450".



27600023



27600022



20073429

Figure 1

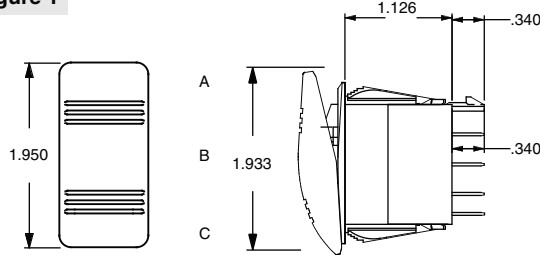

non-illuminated single & double pole rocker switches

Refer to drawings above for dimensions

poles	circuit			rocker color or description	termination	no. of terminals	switch style	ratings
	A	B	C		.250 flat			
S.P.S.T.	ON	-	OFF	black/black		2	1	20A 12VDC
S.P.S.T.	(ON)	-	OFF	black/black		2	1	
S.P.S.T.	(ON)	-	OFF	red rocker		2	1	
S.P.D.T.	ON	OFF	ON	black/black		2	1	
S.P.D.T.	(ON)	OFF	(ON)	black/black		3	1	
D.P.D.T.	ON	OFF	ON	black/black		6	1	
D.P.D.T.	(ON)	OFF	(ON)	black/black		6	1	

illuminated single & double pole rocker switches

S.P.S.T.	ON		OFF	black/red		3	1	20A 12VDC
S.P.S.T.	ON		OFF	black/red		3	1	
D.P.D.T.	ON	OFF	ON	black/red		7	1	

*illuminated rocker switches are all dependant

Call 800.654.4757 for volume pricing and other hardware configurations

switches

Surf 'N Turf™ Rocker Switches

Choose from a variety of actuators and actuations. Each switch is designed to resist both dust and moisture, meets SAE J-1171, UL 1500 requirements and IP 56 rating. These switches are ideal for marine panels, trucks, buses, trailer, construction, farm and recreational equipment. **Recommended mounting hole: .830" (+ 0.015) x 1.450" (+ .005).**



Scan for pricing or go to www.delcity.net/catalogpricing



73471



7600031



7600042

Figure 1

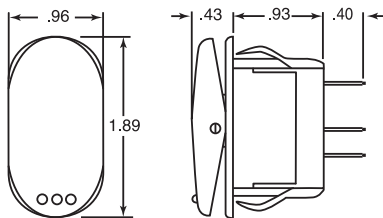

Figure 2

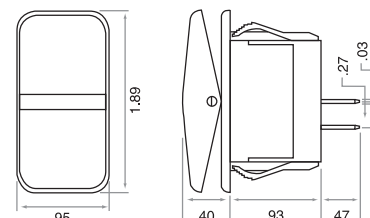

Figure 3

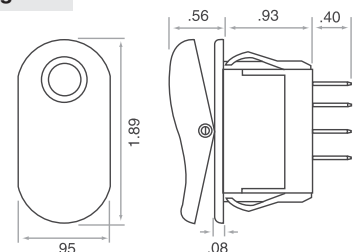
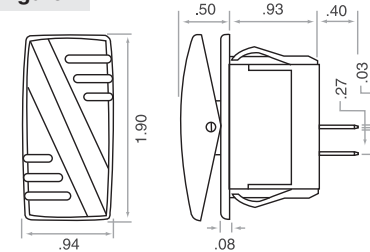



Figure 4



non-illuminated single & double pole rocker switches

Refer to drawings above for dimensions

poles	circuit			rocker color or description	termination 	no. of terminals	switch style	ratings
	A	B	C					
S.P.S.T.	ON	—	OFF	black / black	73420	2	fig. 1	10A @ 250V AC 20A @ 125V AC 21A @ 14V DC
S.P.S.T.	(ON)	—	OFF	black / black	73421DL	2	fig. 1	
S.P.S.T.	(ON)	—	OFF	red / black	7600022	2	fig. 1	
S.P.D.T.	ON	OFF	ON	black / black	73471	3	fig. 1	
S.P.D.T.	(ON)	OFF	(ON)	black / black	73424DL	3	fig. 1	
D.P.S.T.	ON	—	OFF	black / black	73427	4	fig. 1	
D.P.D.T.	ON	—	ON	black / black	73428DL	6	fig. 1	
D.P.D.T.	ON	OFF	ON	black / black	73429	6	fig. 1	
D.P.D.T.	(ON)	OFF	(ON)	black / black	73430	6	fig. 1	
S.P.S.T.	ON	—	OFF	black / black	7600030	2	fig. 2	

illuminated single & double pole rocker switches

S.P.S.T.	ON	—	OFF	red dep	73432	3	fig. 1	21A @ 14V DC
S.P.S.T.	ON	—	OFF	amber dep	73433	3	fig. 1	
S.P.S.T.	ON	—	OFF	green dep	73434	3	fig. 1	
S.P.D.T.	ON	OFF	ON	red dep/red indep	73474	6	fig. 1	
D.P.S.T.	ON	—	OFF	red dep	73476	5	fig. 1	
D.P.D.T.	ON	—	ON	red dep	73477	6	fig. 1	
D.P.D.T.	ON	OFF	ON	red dep/red dep	7600023	7	fig. 1	
S.P.S.T.	ON	—	OFF	black/red dep	7600031	3	fig. 2	
S.P.D.T.	ON	OFF	ON	black/red dep	7600033	4	fig. 2	
S.P.S.T.	ON	—	OFF	red dep	7600035	3	fig. 3	
D.P.D.T.	ON	OFF	ON	red dep	7600036	7	fig. 3	
S.P.S.T.	ON	—	OFF	red dep	7600042	3	fig. 4	
D.P.D.T.	(ON)	OFF	(ON)	red indep	7600044	8	fig. 1	

() Indicates momentary action

Call 800.654.4757 for volume pricing and other hardware configurations



Scan for pricing or go to www.delcity.net/catalogpricing



73280



73281

switches

Surf 'N Turf™ Guardian Series

Slim design allows for use when space is limited. Base and actuator are manufactured from 6/6 nylon material. The IP66 (moisture and dust resistant) rating makes this switch ideal for marine panels, trucks, buses, trailers construction, farm and recreation equipment.

Recommended mounting hole: .600" (± 0.004) x 1.450" (± .004).

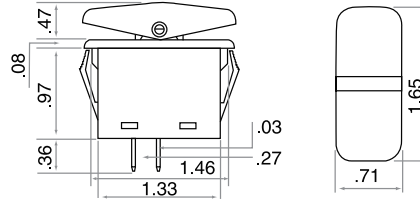

non-illuminated single pole rocker switches

See above for dimensions

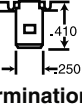
poles	circuit			rocker color or description	termination	no. of terminals	switch style	ratings
	A	B	C		.250 flat			
S.P.S.T.	ON	—	OFF	black/red dep		3	fig. 1	20A @ 14V DC
S.P.S.T.	ON	—	OFF	black/black		2	fig. 1	20A @ 125V DC 1/3 HP 10A @ 250V DC 3/4 HP 10A @ 24V AC
S.P.S.T.	(ON)	—	OFF	black/red		2	fig. 1	
S.P.D.T.	ON	OFF	ON	black/black		3	fig. 1	
S.P.D.T.	(ON)	OFF	(ON)	black/black		3	fig. 1	

() Indicates momentary action

*illuminated red dependent



7400001



7400015

Appliance Rocker Switches

Choose from both illuminated and non-illuminated styles. Manufactured from a durable, black nylon material with the lighted version having a actuator made from a translucent polycarbonate material. The terminals are brass, with the contacts being either copper or silver-plated copper alloy. Can be used in home appliances, computer equipment, automotive and industrial controls.

Recommended mounting hole: .550" x 1.125", and panel thickness of .025" to .170".

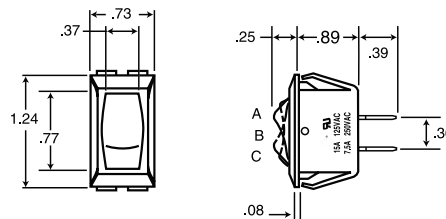

non-illuminated single pole rocker switches

See above for dimensions

poles	circuit			termination	rocker color or description	ratings
	A	B	C	.250 flat		
S.P.S.T.	ON	—	OFF		black	10A @ 250A AC 16A @ 125A AC
S.P.S.T.	ON	—	OFF		black/on off	
S.P.D.T.	ON	—	ON		black	
S.P.D.T.	ON	OFF	ON		black	

() Indicates momentary action

Call 800.654.4757 for volume pricing and other hardware configurations

switches

LED illuminated single pole rocker switches



7400515

See above for dimensions

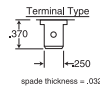

poles	circuit			termination	rocker color or description	ratings
	A	B	C	.250" flat		
S.P.S.T.	ON	—	OFF	7400011	red dep	20A @ 12V DC
S.P.S.T.	ON	—	OFF	7400500	red LED dot	
S.P.S.T.	ON	—	OFF	7400510	blue LED dot	
S.P.S.T.	ON	—	OFF	7400515	green LED dot	



Scan for pricing or go to www.delcity.net/catalogpricing

illuminated single pole rocker switches



7400004

See above for dimensions

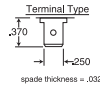

poles	circuit			termination	rocker color or description	ratings
	A	B	C	.250" flat		
S.P.S.T.	ON	—	OFF	7400002	green dep	10A @ 250V AC 16A @ 125V AC
S.P.S.T.	ON	—	OFF	7400003	amber dep	
S.P.S.T.	ON	—	OFF	7400004	red dep	

* illumination is high intensity neon with 1/4 watt 22 K ohm resistor, w/10,000 hour life



73355DL

Snap-in Rocker Switch

Ideal standard rocker switch for all of your DC applications. These two position switches are manufactured from a black nylon material and are illuminated in the "ON" position. **Recommended mounting hole: .500" x 1.000"**.

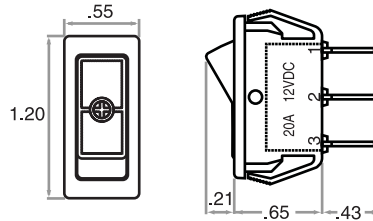

illuminated single pole rocker switches

See above for dimensions



poles	circuit			termination	rocker color or description	ratings
	A	B	C	.250" flat		
S.P.S.T.	ON	—	OFF	73355DL	red	20A @ 12V DC
S.P.S.T.	ON	—	OFF	73365	green	
S.P.S.T.	ON	—	OFF	73375	amber	
S.P.S.T.	ON	—	OFF	73385	blue	

4-way Rocker Switch Panel



This low-profile rocker switch panel utilizes the latest techniques in injection molding to provide a sleek look without sacrificing function. The switch cover is molded with a rubber gasket to help deflect water spray. The rubber overmold allows for comfortable and easy actuation of the recessed switch. Can be mounted both vertically or horizontally. **Switch panel dimensions: 2.50"W x 4.70"L x 1.00"D.**

illuminated single pole toggle switch panel

poles	circuit			description	ratings
	A	B	C		
S.P.S.T.	ON	—	OFF	7500400	4x 15A @ 12V DC

Call 800.654.4757 for volume pricing and other hardware configurations



Scan for pricing or go to www.delcity.net/catalogpricing



7500002

switches

Mini Rocker Switches RoHS

Choose from non-illuminated and illuminated versions. The small footprint is ideal when space is a concern. Recommended uses: industrial controls, computer equipment, home appliances, van conversions and lighting panels. Materials: case and rocker are zytel 101. **Recommended mounting hole: fits .520" x .776".**

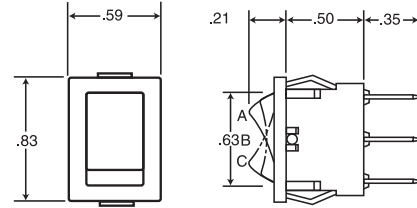

non-illuminated single & double pole rocker switches

See above for dimensions

poles	circuit			termination	rocker color or description	ratings
	A	B	C	.250" flat		
S.P.S.T.	ON	—	OFF	.187	black	16A @ 125V AC 1/3 HP 10A @ 250V AC 1/2 HP
S.P.D.T.	ON	—	ON	7500002	black	
S.P.D.T.	ON	OFF	ON	7500005	black	
S.P.D.T.	(ON)	OFF	(ON)	7500006	black	6A @ 250V AC 12A @ 125V AC 1/2 HP 125-250V AC
D.P.S.T.	ON	—	OFF	7500007	black	
D.P.D.T.	ON	—	ON	7500008	black	
D.P.D.T.	ON	OFF	ON	7500009	black	1/2 HP 125-250V AC
D.P.D.T.	ON	OFF	ON	7500010	black	
D.P.D.T.	(ON)	OFF	(ON)	7500011	black	

() Indicates momentary action

illuminated single pole rocker switch

See above for dimensions



7500013

poles	circuit			termination	rocker color or description	ratings
	A	B	C	.250" flat		
S.P.S.T.	ON	—	OFF	.187	red dep	16A @ 125V AC 1/3 HP 10A @ 250V AC 1/2 HP
S.P.S.T.	ON	—	OFF	7500004	red dep	
S.P.S.T.	ON	—	OFF	7500013	red dep	10A @ 12V DC

illumination is high intensity neon with 1/4 watt 33 k ohm resistor, w/10,000 hour life

Rectangle Face, Round Hole Rocker Switch RoHS

These standard non-illuminated and incandescent bulb rocker switches are ideal for any 12V DC application. The rectangle design allows for a seamless and uniform look when installed. **Recommended mounting hole: .500" diameter.**

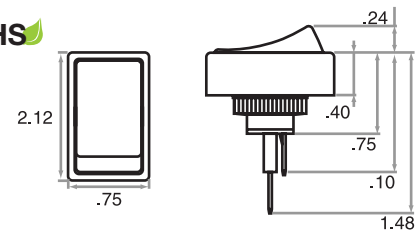

illuminated single pole rocker switches

poles	circuit			termination	rocker color or description	ratings
	A	B	C	.250" flat		
S.P.S.T.	ON	—	OFF	.16	black	30A @ 12V DC
S.P.S.T.	ON	—	OFF	73310	red	
S.P.S.T.	ON	—	OFF	73312DL	amber	
S.P.S.T.	ON	—	OFF	73314	blue	
S.P.S.T.	ON	—	OFF	73316	green	

Call 800.654.4757 for volume pricing and other hardware configurations

switches

Oval Face, Round Hole Rocker Switch



7700100

These standard LED illuminated rocker switches are aesthetically pleasing and easy to install. Housing and actuator are manufactured from nylon material for durability. **Recommended mounting hole: .500" diameter.**

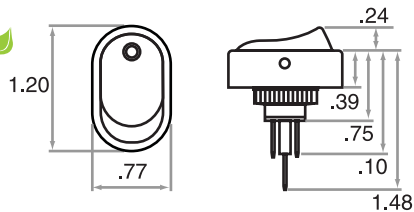

Scan for pricing or go to www.delcity.net/catalogpricing

LED illuminated single pole rocker switches

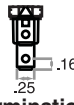

7700200

poles	circuit			termination	rocker color or description	ratings
	A	B	C	.250" flat		
S.P.S.T.	ON	—	OFF		red LED dot	30A @ 12V DC
S.P.S.T.	ON	—	OFF	7700100	green LED dot	
S.P.S.T.	ON	—	OFF	7700110	amber LED dot	
S.P.S.T.	ON	—	OFF	7700115	blue LED dot	
S.P.S.T.	ON	—	OFF	7700200*	full face red	

* incandescent bulb

Rectangle Face, Round Hole Rocker Switch



These AC rated rockers are specially designed for compact space. Black nylon housing (UL Flame: 94V-2) with .110 terminals. **Recommended mounting hole: .480" diameter.**

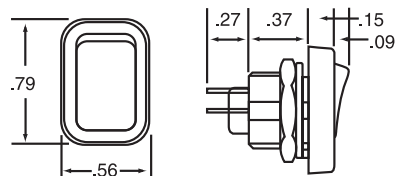

non-illuminated single & double pole rocker switches

poles	circuit			termination	rocker color or description	ratings
	A	B	C	.110" flat		
S.P.S.T.	ON	—	OFF		black	3A @ 250A AC 6A @ 125A AC
S.P.D.T.	ON	-	ON	7500072	black	
D.P.S.T.	ON	—	OFF	7500073	black	

Rectangle Face, Round Hole Rocker Switch



Dust resistant black nylon housing (UL Flame: 94V-2) with back-up nut design. Connection points are silver plated brass. **Recommended mounting hole: .708" diameter.**

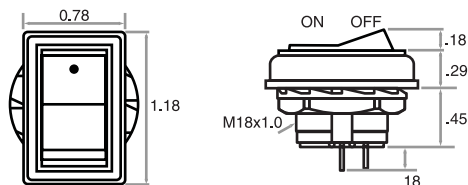

non-illuminated single pole rocker switch

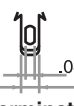
poles	circuit			termination	rocker color or description	ratings
	A	B	C	.110" flat		
S.P.S.T.	ON	—	OFF		black, white dot	6A @ 125V AC 3A @ 250V AC

Call 800.654.4757 for volume pricing and other hardware configurations



Scan for pricing or go to www.delcity.net/catalogpricing



switches

Window Momentary Switch

Can be used for door locks, power windows or electronic antennas. Switch easily and quickly snaps into mounting hole.

Recommended mounting hole: .875" x 1.187".

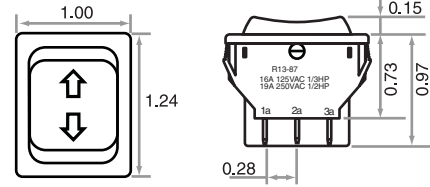

non-illuminated double pole rocker switch

poles	circuit			termination	rocker color or description	ratings
	A	B	C	.187" flat		
D.P.D.T.	(ON)	OFF	(ON)	73553DL	black, white arrow	20A @ 12V DC 16A @ 125V AC 1/3 HP 10A @ 250V AC 1/2 HP

() Indicates momentary action

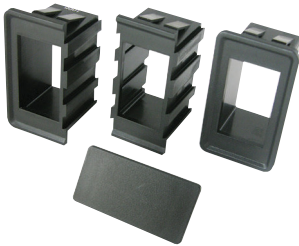

Modular Brackets

A quick and clean system to mount switches. Can be assembled in countless configurations to meet your switch needs. Manufactured to accommodate our Full Size Rocker Series and Surf 'N Turf™ Sealed Rockers. Creating your own switch panel has never been easier.

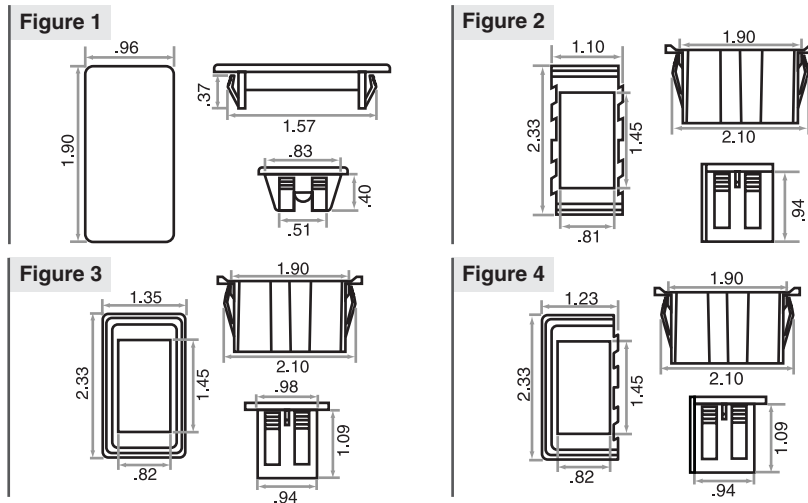

modular mounting brackets

part no.	description	figure
8000203	rocker panel plug	1
8000204	middle rocker panel	2
8000205	single rocker bracket	3
8000206	end rocker panel	4

Call 800.654.4757 for volume pricing and other hardware configurations

switches



7500015



7500074



7500090



7500087

Square Face, Round Hole Rocker Switches

Choose from a variety of both non-illuminated and illuminated styles. The dust resistant housing is manufactured from nylon material (UL Flame: flammability rating 94V-2) and comes with a back-up nut for secure panel mounting. **Recommended mounting hole: .787" diameter.**

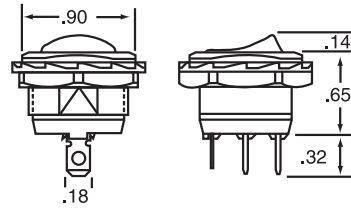

Scan for pricing or go to www.delcity.net/catalogpricing

non-illuminated single pole rocker switches

See above for dimensions

poles	circuit			termination	rocker color or description	ratings
	A	B	C	.187" flat		
S.P.S.T.	ON	—	OFF		black	10A @ 250V AC 16A @ 125V AC 10A @ 12V DC
S.P.S.T.	ON	—	OFF		black, white dot	
S.P.S.T.	ON	—	OFF		black/red	
S.P.D.T.	(ON)	—	OFF		black	
S.P.D.T.	ON	-	ON		black	
S.P.D.T.	ON	OFF	ON		black	

() Indicates momentary action

LED illuminated single pole rocker switches

See above for dimensions

poles	circuit			termination	rocker color or description	ratings
	A	B	C	.187" flat		
S.P.S.T.	ON	—	OFF		red rect	10A @ 250V AC 16A @ 125V AC
S.P.S.T.	ON	—	OFF		green rect	

* additional terminal for 2.2V LED illumination

illuminated single pole rocker switches

See above for dimensions

poles	circuit			termination	rocker color or description	ratings
	A	B	C	.187" flat		
S.P.S.T.	ON	—	OFF		red dot	10A @ 250V AC 16A @ 125V AC
S.P.S.T.	ON	—	OFF		green dot	

Call 800.654.4757 for volume pricing and other hardware configurations



Scan for pricing or go to www.delcity.net/catalogpricing



7510000

Square Face, Round Hole Rocker Switches

Choose from a variety of color illuminations. The dust resistant housing is manufactured from nylon material (UL Flame: flammability rating 94V-2) and comes with a back-up nut for secure panel mounting. **Recommended mounting hole: .787" diameter.**

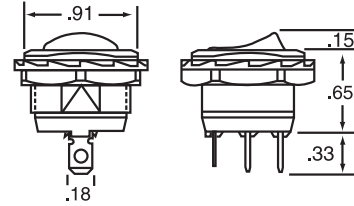

LED illuminated single pole rocker switches

See above for dimensions

poles	circuit			termination	rocker color or description	ratings
	A	B	C	.187" flat		
S.P.S.T.	ON	—	OFF	7510000	red dot	20A @ 12V DC
S.P.S.T.	ON	—	OFF	7510005	amber dot	
S.P.S.T.	ON	—	OFF	7510010	green dot	



7500710

Square Face, Round Hole Snap-in Rocker Switches

These rocker switches feature a long-lasting LED light that brightly illuminates when switch is activated. Installation is easy with the snap-in design. Manufactured from nylon material for added durability. **Recommended mounting hole: .945" diameter.**

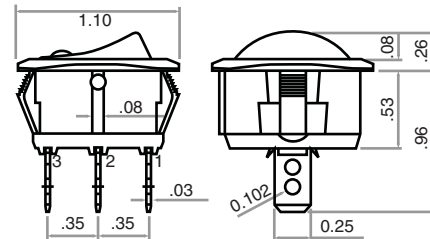

LED illuminated single pole rocker switches

See above for dimensions

poles	circuit			termination	rocker color or description	ratings
	A	B	C	.250" flat		
S.P.S.T.	ON	—	OFF	7500700	red dot	25A @ 12V DC
S.P.S.T.	ON	—	OFF	7500705	amber dot	
S.P.S.T.	ON	—	OFF	7500710	blue dot	
S.P.S.T.	ON	—	OFF	7500715	green dot	
S.P.S.T.	ON	—	OFF	7500720	white dot	



Crimp & Shrink Terminal Assortment Kit with Tools – *The Tuxedo™*

Perfectly suited for most connection projects, this kit is accessorized with both a hand crimper and heat gun. The kit contains ring terminals, butt connectors and push-on terminals. Terminals are UL listed and are self-sealing shrink tube. All contained within a durable, lightweight, translucent plastic carrying case (11" x 6 3/4" x 1 3/4").

For a complete listing of kit contents, see page 329.

part no.	description	pieces
809	Tuxedo™ shrink tube terminal kit	122

Call 800.654.4757 for volume pricing and other hardware configurations

switches

Round Hole Rocker Switches

Compatible with a wide range of standard panel cutouts. Choose from both non-illuminated and AC illuminated switches. These round hole rockers are qualified with several international approvals. The housing is manufactured from nylon (flammability rating: UL 94V-2) with the terminals being brass with silver plated brass terminals.

Recommended mounting hole: .795" diameter.



7500020



7500066

single pole

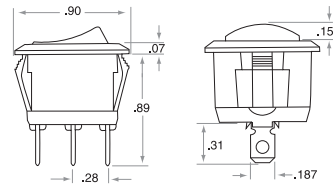

double pole

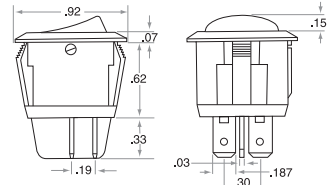

non-illuminated single & double pole rocker switches

Refer to drawings above for dimensions

poles	circuit			termination	rocker color or description	ratings
	A	B	C	.187" flat		
S.P.S.T.	ON	—	OFF		black	6A @ 250V AC 10A @ 125V AC 10A @ 12V DC
S.P.S.T.	ON	—	OFF	7500020	black/red	
S.P.S.T.	ON	—	OFF	7500050	white	
S.P.D.T.	(ON)	—	OFF	7500067	black	
S.P.D.T.	ON	—	ON	7500021	black	
S.P.D.T.	ON	OFF	ON	7500022	black	
S.P.D.T.	(ON)	OFF	(ON)	7500023	black	
D.P.D.T.	ON	OFF	ON	7500026	black	10A @ 250V AC 16A @ 125V AC 10A @ 12V DC
D.P.D.T.	(ON)	OFF	(ON)	7500027	black	

() Indicates momentary action

illuminated single & double pole rocker switches

Refer to drawings above for dimensions

poles	circuit			termination	rocker color or description	ratings
	A	B	C	.187" flat		
S.P.S.T.	ON	—	OFF		red	6A @ 250V AC 10A @ 125V AC
S.P.S.T.	ON	—	OFF	7500025	amber	
S.P.S.T.	ON	—	OFF	7500029	green	



7500025

LED illuminated single pole rocker switches

See above for dimensions

poles	circuit			termination	rocker color or description	ratings
	A	B	C	.187" flat		
S.P.S.T.	ON	—	OFF		red dot	20A @ 14V DC
S.P.S.T.	ON	—	OFF	7520000	amber dot	
S.P.S.T.	ON	-	OFF	7520010	blue dot	
S.P.S.T.	ON	—	OFF	7520015	green dot	



7520005

Call 800.654.4757 for volume pricing and other hardware configurations



Scan for pricing or go to www.delcity.net/catalogpricing



Scan for pricing or go to www.delcity.net/catalogpricing



7500076

switches

Round Hole Rocker Switches

Compatible with a wide range of standard panel cutouts. Choose from both non-illuminated and AC and DC illuminated switches. These round hole rockers are qualified with several international approvals. The housing is manufactured from nylon (flammability rating: UL 94V-2) with silver-plated brass terminals. **Recommended mounting hole: .795" diameter.**

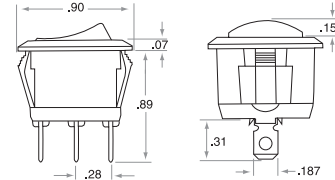

LED illuminated single pole rocker switches

See above for dimensions

poles	circuit			termination	rocker color or description	ratings
	A	B	C	.187" flat		
S.P.S.T.	ON	—	OFF		red rect	6A @ 250V AC 10A @ 125V AC
S.P.S.T.	ON	—	OFF	7500076*	amber rect	
S.P.S.T.	ON	—	OFF	7500077*	green rect	
S.P.S.T.	ON	—	OFF	7500078*	blue rect	
S.P.S.T.	ON	—	OFF	7500079*		

* additional terminal for 2.2V LED illumination



7500036

illuminated single pole rocker switches

See above for dimensions

poles	circuit			termination	rocker color or description	ratings
	A	B	C	.187" flat		
S.P.S.T.	ON	—	OFF		red LED	20A @ 12V DC
S.P.S.T.	ON	—	OFF	7500036	amber incandescent	
S.P.S.T.	ON	—	OFF	7500037	green LED	
S.P.S.T.	ON	—	OFF	7500038	blue LED	
S.P.S.T.	ON	—	OFF	7500039		



73556

Round Rocker Switches

Available with a variety of legend options. Materials: .187" silver-plated brass terminals with nylon frame (flammability: UL 94V-2). Snap-in mounting design allows for ease of installation into .79" diameter mounting hole. Refer to drawings on page 126 for dimensions. **Recommended mounting hole: .795" diameter.**

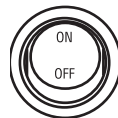

73556



7500030



7500031



7500098

non-illuminated single and double pole rocker switches

See above for dimensions

poles	circuit			termination	rocker color or description	ratings
	A	B	C	.187" flat		
S.P.S.T.	ON	—	OFF		On-Off	6A @ 250V AC 10A @ 125V AC
S.P.S.T.	ON	—	OFF	73556	white dot	
S.P.S.T.	ON	—	OFF	7500030	I O	
D.P.D.T.	ON	OFF	ON	7500031	H-OFF-L	10A @ 250V AC 16A @ 125V AC
				7500098		

Call 800.654.4757 for volume pricing and other hardware configurations

switches

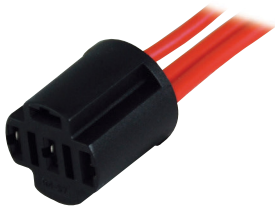

Round Hole Rocker Switch Mounting Harness

Install your next switch with ease. The harness base is manufactured from a nylon material and easily snaps into place on any .187", 3 terminal, S.P.S.T. round rocker switch. The base is pre-wired with 7", red, 16 AWG wire leads.

part no.	description
7400750	S.P.S.T. 3 terminal mounting harness

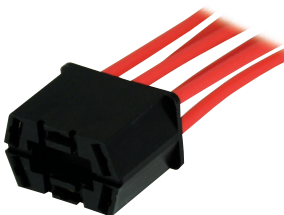

Toggle Switch Mounting Harness

Install your next switch with ease. The harness base is manufactured from a nylon material and easily snaps into place on any .250", 6 terminal, D.P.D.T. toggle switch. The base is pre-wired with 7", red, 16 AWG wire leads.

part no.	description
7400700	D.P.D.T. 6 terminal mounting harness



6-way Toggle Switch Panel

This IP 56 rated switch panel provides a spray-proof and aesthetically pleasing way to control up to 6 different mechanisms. The included toggle boots provide protection of the S.P.S.T., ON-OFF switch from harsh environments. Each switch is pre-wired with ATC®/ATO® fuse and fuse holder. **Switch panel dimensions: 3.75"H x 4.25"W x 2.90"D.**

non-illuminated single pole toggle switch panel

poles	circuit			description	ratings
	A	B	C		
S.P.S.T.	ON	—	OFF	7200400	6x 15A @ 12V DC

4-way Rocker Switch Panel

This low-profile rocker switch panel utilizes the latest techniques in injection molding to provide a sleek look without sacrificing function. The switch cover is molded with a rubber gasket to help deflect water spray. The rubber overmold allows for comfortable and easy actuation of the recessed switch. Can be mounted both vertically or horizontally. **Switch panel dimensions: 2.50"W x 4.70"L x 1.00"D.**



illuminated single pole switch panel

poles	circuit			description	ratings
	A	B	C		
S.P.S.T.	ON	—	OFF	7500400	4x 15A @ 12V DC

Round Rocker Switch Panel, Fused

Designed for interior use, this versatile panel allows for vertical or horizontal mounting. All 6 switches are dependent red illuminated. Each switch is pre-wired with a panel-mounted ATC®/ATO® fuse and fuse holder. The faceplate is easily removeable to allow quick access to each fuse. **Switch panel dimensions: 4.25"W x 4.25"L x 1.00"D**



LED illuminated single pole switch panel

poles	circuit			description	ratings
	A	B	C		
S.P.S.T.	ON	—	OFF	7500450	50A max @ 12V DC



Scan for pricing or go to www.delcity.net/catalogpricing



Scan for pricing or go to www.delcity.net/catalogpricing

switches

Push-Button Switches

Choose from a variety of colors, termination styles and actuations. They are ideal for appliances, sound amplification and vacuum cleaners. The frames are manufactured steel with a bright nickel plating, with the base being a black phenolic plastic. The actuator is a black zytel and all other external parts are brass/bright nickel.

Recommended mounting hole: .500" diameter.



7100010



7100005



7100001



7100003

Figure 1

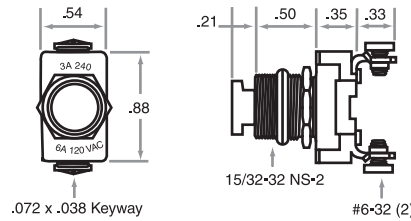

SPECIFICATIONS:
3A/240V AC
6A/120V AC

Figure 2

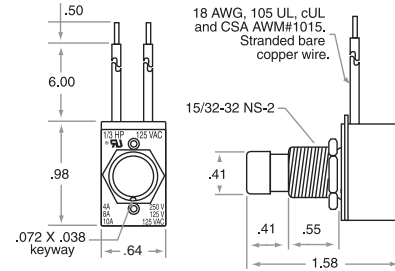

SPECIFICATIONS:
3A/240V AC 3/4 HP 125V AC
6A/120V AC 10A/125V AC

Figure 3

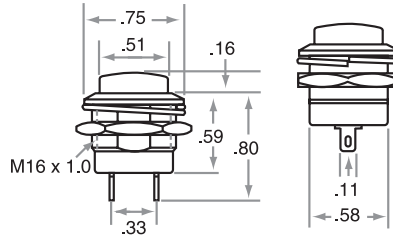

Recommended mounting hole: .625" dia.
8A/125V AC
4A/250V AC

non-illuminated single pole push button switches

poles	circuit			.250" flat		screw		description	switch style	ratings
	A	B	C	OEM	assembled	OEM	assembled			
S.P.S.T.	OFF	—	ON	—	—	—	7100010	black	fig. 2	4A @ 250V AC 8A @ 125V AC 1/3 HP 125V AC
S.P.S.T.	OFF	—	ON	—	—	—	7100014	chrome	fig. 2	
S.P.S.T.	OFF	—	(ON)	7100001	—	—	—	red	fig. 1	3A @ 240V AC 6A @ 120V AC
S.P.S.T.	OFF	—	(ON)	7100002	—	—	—	black	fig. 1	
S.P.S.T.	OFF	—	(ON)	—	7100003	—	—	black	fig. 1	
S.P.S.T.	OFF	—	(ON)	7100011	—	—	—	white	fig. 1	
S.P.S.T.	ON	—	(OFF)	—	7100004	—	—	red	fig. 1	3A @ 277V AC 6A @ 120V AC
S.P.S.T.	OFF	—	(ON)	—	—	7100005	—	red	fig. 3	3A @ 250V AC 6A @ 125V AC

() Indicates momentary action

Call 800.654.4757 for volume pricing and other hardware configurations

switches



Push-Button Boot

Help protect your push-button switch from water-spray, dust and other harmful elements. Manufactured from tough EPDM rubber, with a hex-nut molded into the base for easy installation. The boot is designed to work with #7100001 through 7100004 and 7100011 (page 129). Temperature rating of -40°C to 110°C (-40°F to 230°F).

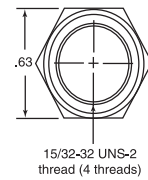

Scan for pricing or go to www.delcity.net/catalogpricing

part no.	description
7900002	push-button boot



Non-illuminated Push-Button Round Hole Switch

Affordable and durable, these switches are designed for numerous troublefree actuations. The housing is manufactured from black, bakelite material. Choose from four different colors.

Recommended mounting hole: .500" diameter.

non-illuminated single pole push-button switches

poles	circuit			termination	rocker color or description	ratings
	A	B	C	.110" flat		
S.P.S.T.	(ON)	—	OFF	73911	black	1.5A @ 250V AC 3A @ 125V AC
S.P.S.T.	(ON)	—	OFF	73912	blue	
S.P.S.T.	(ON)	—	OFF	73913	red	
S.P.S.T.	(ON)	-	OFF	73915	yellow	

() Indicates momentary action



Push-Button Horn Switch

Momentary push-button switch is designed for operating horns and sirens. Easy installation with two screw mounting and wire hook-up. Housing is made from chrome-plated brass with black plastic for the actuator. Overall length: 2.625". Mounting length: 2.225".

Recommended mounting length: 2.063".

non-illuminated single pole push-button switches

poles	circuit			termination screw mount	rocker color or description	ratings
	A	B	C			
S.P.S.T.	(ON)	—	OFF	73465	black	15A @ 12V DC

() Indicates momentary action



Hi-Amp Push-Button Switch

This heavy-duty push-button switch features die cast construction with silver/copper contacts for long life. The rubber boot provides protection from dust, debris and moisture. The mounting stem has 5/8" 32 UNS for panels up to .500" thick. IP66 rated.

Recommended mounting hole: .625" diameter.

non-illuminated single pole push-button switch

poles	circuit			termination screw mount	rocker color or description	ratings
	A	B	C			
S.P.S.T.	(ON)	—	OFF	73475	chrome	50A @ 12V DC

() Indicates momentary action

Call 800.654.4757 for volume pricing and other hardware configurations



Scan for pricing or go to www.delcity.net/catalogpricing



73495

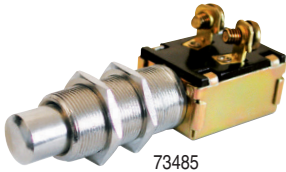

73485

Push-Button Switch

Insulated type, push-button starter and horn switches. The 73495 features a moisture and dust-proof rubber cap. Both can be mounted through panels up to 1" thick. The 73485 is supplied with chrome-plated, brass face nut and back-up nut. Overall length: 2.875", and width: .875". **Recommended mounting hole: .625" diameter.**

non-illuminated single pole push-button switches

poles	circuit			termination screw mount	rocker color or description	ratings
	A	B	C			
S.P.S.T.	(ON)	—	OFF	73495	chrome	25A @ 6V DC
S.P.S.T.	(ON)	—	OFF	73485	chrome	15A @ 12V DC

() Indicates momentary action

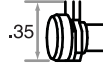

72960

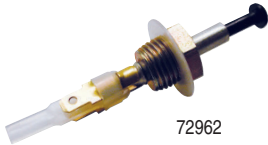

72962

Push-Button Door Switch

Designed to work within doors as a grounding (-) switch. Can be wired directly to the dome light or used as a vehicle alarm system alert switch. The switches are self adjusting and have an overall length of 2.718".

Recommended mounting hole: 72960 – .313" diameter, 72962 – .500" diameter.

non-illuminated single pole push-button switch

poles	circuit			termination .250" flat	rocker color or description	ratings
	A	B	C			
S.P.S.T.	(ON)	—	OFF	72960	black	10A @ 12V DC
S.P.S.T.	(ON)	—	OFF	72962	black	

() Indicates momentary action

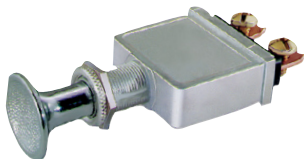

Push-Pull Switch

Extra heavy-duty, 2 position switch. The rugged die cast housing provides strength and durability to fit numerous applications. The chrome plated handle finishes off a professional look. Handle length: .678". **Recommended mounting hole: .468" diameter.**

single pole push-pull switch

poles	circuit			termination screw mount	rocker color or description	ratings
	A	B	C			
S.P.S.T.	ON	—	OFF	73165	chrome	75A @ 6–28V DC

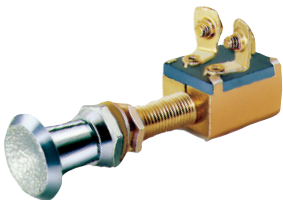

Push-Pull Switch

Heavy-duty, 2 position switch. Housing is manufactured from brass material. The chrome plated handle offers a professional look. The extended handle allows installation in up to 1" panel thickness. Overall length: 3.125", width: .375", stem length: 1.250".

Recommended mounting hole: .375"

single pole push-pull switch

poles	circuit			termination screw mount	rocker color or description	ratings
	A	B	C			
S.P.S.T.	ON	—	OFF	73405	chrome	15A @ 12V DC 25A @ 6V DC



Call 800.654.4757 for volume pricing and other hardware configurations

switches

Keyed Ignition Switch

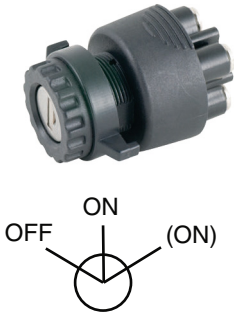

Starter switch is manufactured from black PBT for durability. The 4 position switch has standard screw terminals for easy hook-up and comes with 2 keys.

3-position switch

circuit				stud size .438	description	ratings
A	B	C	D			
OFF	ON	(ON)	-	73463	ignition switch	15A @ 12V DC

() Indicates momentary action



Scan for pricing or go to www.delcity.net/catalogpricing

Keyed Ignition Switch

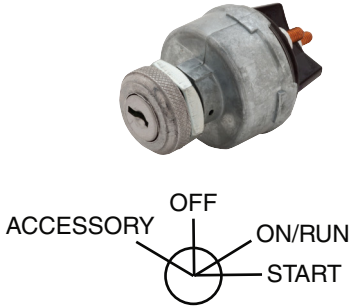

Starter switch is manufactured from plated steel for long life and durability. The 4 position switch has standard screw terminals for easy hook-up and comes with 2 keys. **Recommended mounting hole: .750" diameter.**

4-position switch

circuit				stud size .438	description	ratings
A	B	C	D			
accessory	OFF	run	(start)	73455DL	ignition switch	30A @ 12V DC

() Indicates momentary action

Lamp Cord Switch



Constructed of black phenolic, heat resistant material. This switch can be used on SVT 18/2 and SU 18/2 cords only. UL file number E223490. Temperature rating: -20°C to 85°C (-4°F to 185°F).

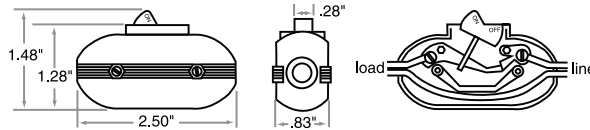

non-illuminated single pole lamp switches

poles	circuit			termination screw mount	actuator color	ratings
	A	B	C			
S.P.S.T.	ON	—	OFF	7900020	red	6A @ 250V AC 10A @ 125V AC

Ripcord



6 1/2" plastic spool

Ripcord is parallel wire suitable for alarm systems or light extension cords. The PVC insulation is coded for easy identification; Type SPT-1. The plastic insulation is 1/32" thick. Rated 300V RMS. The insulation operates optimally between the temperatures of -20°C to 60°C (-4°F to 140°F).



part no.	gauge/ conductors	outside diameter	standard spool size	lbs per spool	color	spool diam.
218102	18-2	.112" x .210"	250'	5	white	6-1/2
218105	18-2	.112" x .210"	250'	5	black	6-1/2
218107	18-2	.112" x .210"	250'	5	brown	6-1/2
21814002	18-2	.112" x .210"	5000'	101	white	-
21814005	18-2	.112" x .210"	5000'	101	black	-
21814007	18-2	.112" x .210"	5000'	101	brown	-

Call 800.654.4757 for volume pricing and other hardware configurations

switches

Push Button Engine Start Switches

Easily start your engine with the press of a button. These switches are manufactured with an ABS chrome bezel to provide a unique, custom look. The large lens provides ample room for thumb or index finger actuation. The switches easily mount into a .875" hole with a panel thickness up to .354". Wire connecting is made easy with M4 terminals for optimum connection. Starter solenoid recommended with use.

Recommended mounting hole: .875" diameter.



Scan for pricing or go to www.delcity.net/catalogpricing



73611



73613



73622

73623

LED illuminated single pole push button switches

circuit			termination screw mount	description	rating
A	B	C			
(ON)	—	OFF	73611	red engine start	50A @ 12V DC
(ON)	—	OFF	73612	green engine start	
(ON)	—	OFF	73613	blue engine start	

LED illuminated single pole push button switches

circuit			termination screw mount	description	rating
A	B	C			
(ON)	—	OFF	73621	red	50A @ 12V DC
(ON)	—	OFF	73622	green	
(ON)	—	OFF	73623	blue	



Universal Lanyard Kill Switch

This marine emergency cut-off safety switch attaches to your life vest while operating a boat or personal watercraft. Switch includes 15" resting, 48" working length coil, and weatherproof housing with brass .250" male terminals. Dual circuitry allows for ignition or magneto kill. Can be mounted up to .375" panel thickness. **Recommended mounting hole: .625" diameter.**

universal lanyard switch

circuit			stud size .250" flat	description	ratings
A	B	C			
ON	—	OFF	73459	lanyard switch	15A @ 12V DC



Master Battery Disconnect Switch with on/off Faceplate

This battery disconnect switch is lever operated to disconnect power for the battery circuit only. The alternator or generator field circuit will remain powered. Rated for 1000A in-rush. Mounting stem length: .782". Conforms to UL 558. **Recommended mounting hole: .750" diameter.**

INFORMATION

NOTE: On vehicles equipped with an alternator, the engine must be shut-off to avoid potential damage to alternator diode. Instruction sheets are included.

2-position disconnect switch

circuit			stud size .375"	description	ratings
A	B	C			
ON	—	OFF	5400*	battery disconnect	180A @ 6-36V DC

* includes faceplate

Call 800.654.4757 for volume pricing and other hardware configurations

switches



Master Disconnect Switch for Batteries

A detachable key allows this waterproof switch to function as a battery disconnect, and a theft deterrent device. Base is manufactured from impact resistant plastic material.



Scan for pricing or go to www.delcity.net/catalogpricing

INFORMATION

Maximum load (10 seconds): 12 volts, 1000 amps; 24 volts, 500 amps.
Maximum continuous rating: 12 volts, 50 amps; 24 volts, 25 amps.

single pole switches

circuit			stud size .375"	description	ratings
A	B	C			
ON	—	OFF	79997	battery disconnect	50A @ 12V DC 25A @ 24V DC
—	—	—	8000021	replacement key	

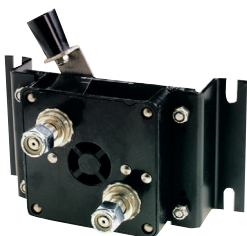

Heavy-duty Master Disconnect Switch for Batteries

A non-fused current interrupt disconnect switch designed for opening the circuit between a battery and the complete electrical load of a battery-powered system. Vehicle cranking and maximum surge currents to 2,000A based on 20% duty cycle ON times of 5 seconds maximum. Temperature rating of 150°C (302°F) maximum. Ideal for heavy truck applications.

2-position switch

circuit			stud size .500"	description	ratings
A	B	C			
ON	—	OFF	79995	battery disconnect	400A @ 50V AC 400A @ 50V DC



5413

Master Disconnect Switches for Batteries

Choose from either a medium or heavy-duty disconnect switch. Both feature the patented contour locking system allowing for multiple switches to be located in one area. Can be surface or through-panel mounted. Both have tin plated studs for wire mounting (medium-duty studs – .375", heavy-duty studs – .500"). Dimensions: 5413 – 2.75" x 2.75" x 3.00", 5414 – 4.00" x 4.00" x 3.50".



5414

INFORMATION

5413 rated for 48V DC, 455A intermittent, 1250A cranking
 5414 rated for 48V DC, 800A intermittent, 2500A cranking

2-position disconnect switch

circuit			stud size .375"/.500"	description	ratings
A	B	C			
ON	—	OFF	5413*	battery disconnect	275A @ 48V DC
ON	—	OFF	5414	battery disconnect	600A @ 48V DC

* removable key

Call 800.654.4757 for volume pricing and other hardware configurations



Scan for pricing or go to www.delcity.net/catalogpricing



switches

Master Disconnect Switch for Batteries – “Easy Fit”

This versatile and easy to install battery switch is ignition protected and meets ABYC standards for exposed terminals. Can be surface or through panel mounted. With a removable key, can be used as a lockout device. Two .375", tin plated studs for wire hook-up. **Dimensions: 2.75" x 2.75" x 4.30"**.

INFORMATION

5412 is rated 48V DC, 400A intermittent, 1250 cranking

2-position disconnect switch

circuit			stud size .375"	description	ratings
A	B	C			
ON	—	OFF	5412	battery disconnect	275A @ 48V DC



Electric Battery Disconnect Switch (remote)

Disconnect power from the comfort of your seat with this remote controlled, ignition protected battery disconnect switch. Ideal to reduce long runs of large cable that can result in voltage drop. Install in any convenient location near the battery and run the 14" lead wire to any remote switch (not included). Features a manual override switch.

Dimensions: 4.00" x 4.00" x 4.20"

INFORMATION

5415 is rated 12–24V DC, 400A intermittent, 1250 cranking

2-position battery disconnect switch

circuit			stud size .375"	description	ratings
A	B	C			
ON	—	OFF	5417	battery disconnect	300A @ 12–24V DC



Dual Battery Disconnect/Selector Switch

Allows for selection of either battery, both batteries in parallel, or complete disconnect of both batteries. The Alternator Field Disconnect (AFD) allows selection of any position, including “off” without damaging the alternator or electrical system. Three hole surface mounting.

Diameter: 5.500", height: 2.625".

4-position battery selector switch

circuit				stud size .375"	description	rating
A	B	C	D			
OFF	1	BOTH	2	5408"	battery selector switch	230A @ 6–36V DC 345A intermittent

Battery Disconnect Switch

Most economical switch to disconnect power for the battery circuit. Manufactured from tough, glass-filled polycarbonate material. Three hole surface mounting. Two .375" studs for wire hook-up. **Diameter: 5.500", height: 2.625"**.

single pole battery selector switch

circuit			stud size .375"	description	ratings
A	B	C			
ON	—	OFF	5410	battery disconnect switch	230A @ 6–36V DC 345A intermittent



Call 800.654.4757 for volume pricing and other hardware configurations

switches



Heavy-duty Dual Battery Disconnect Switch

Allows for selection of either battery, two batteries in parallel or complete disconnect of both batteries. The Alternator Field Disconnect (AFD) allows selection of any position, including "off", without damaging the alternator or electrical system. Manufactured with a glass-filled polycarbonate case. **Diameter: 5.50"**, **height: 3.50"**.

4-position battery selector switch

circuit				stud size .625"	description	rating
A	B	C	D			
OFF	1	BOTH	2	5404	battery selector switch	360A @ 6–36V DC 600A intermittent



Scan for pricing or go to www.delcity.net/catalogpricing



Heavy-duty Battery Disconnect Switch

The Alternator Field Disconnect (AFD) allows selection of any position, including "off", without damaging the alternator or electrical system. Manufactured with a glass-filled polycarbonate case. **Diameter: 5.50"**, **height: 3.50"**.

battery disconnect switch

circuit			stud size .625"	description	ratings
A	B	C			
ON	—	OFF	5406	battery disconnect switch	60A @ 6–36V DC 1000A intermittent



73396



73387DL

LED Indicator Lights

The up to 100,000 hour life expectancy of LEDs make these lights perfect for a variety of DC applications. Indicator lights are manufactured with a chrome housing and nylon base. Temperature rating of 85°C (185°F). Leaded version comes with 20 AWG wire. **Recommended mounting hole: .438" diameter.**

Figure 1

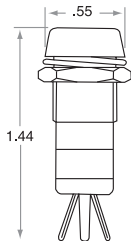
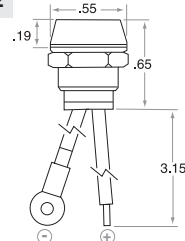

Figure 2



LED indicator lights

color	illumination style	termination	part no.	figure drawing	ratings
red	non-flashing	.250" tabs	73396	fig. 1	15mA @ 12V DC
amber	non-flashing	.250" tabs	73397	fig. 1	
green	non-flashing	.250" tabs	73398	fig. 1	
red	non-flashing	lead wire	73386	fig. 2	
amber	non-flashing	lead wire	73387DL	fig. 2	
green	non-flashing	lead wire	73388DL	fig. 2	
blue	non-flashing	lead wire	73380	fig. 2	

Call 800.654.4757 for volume pricing and other hardware configurations



Scan for pricing or go to www.delcity.net/catalogpricing



LED Pigtail Indicator Lights

The up to 100,000 hour life expectancy of LEDs make these lights perfect for a variety of DC applications. The small diameter and easy snap-in design allows for an ideal installation when space is a concern. Features one red and one yellow 6", 24 gauge lead wire.

Recommended mounting hole: .313" diameter.

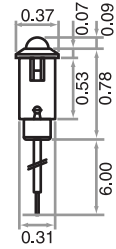

LED indicator lights

color	illumination style	termination	part no.	ratings
red	non-flashing	lead wire	73581	30mA @12V DC
amber	non-flashing	lead wire	73482	
green	non-flashing	lead wire	73483	
blue	non-flashing	lead wire	73484	
red	flashing	lead wire	73583	
amber	flashing	lead wire	73382	
green	flashing	lead wire	73383DL	



Pigtail Indicator Lights

Snap-in design makes installation quick and easy. The incandescent lamp provides illumination when power is applied. Features one 3" and one 5" 18 gauge lead wire. **Recommended mounting hole: .500" diameter.**

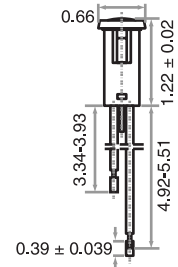

indicator lights

color	illumination style	termination	part no.	ratings
red	non-flashing	lead wire	73415	3A @ 12V DC
green	non-flashing	lead wire	73425DL	
amber	non-flashing	lead wire	73435DL	
blue	non-flashing	lead wire	73445	



Professional Grade Ergo Strippers

These wire strippers feature nick-resistant, stainless steel blades & Dual Grip™ ergonomically-shaped handles. The 909550 also crimps #22-#10 gauge insulated terminals. The 909560 features a contoured grip for ease of use. All feature an extended handle to allow for a closer grip to the stripping area.

part no.	description	strip gauges
909550	ergo multi stripper	20-10 ga
909555	ergo multi tool - crimp & strip	22-10 ga
909560	contour ergo multi stripper	20-10 ga

Call 800.654.4757 for volume pricing and other hardware configurations

switches

Canopy Switches

Canopy switches are designed for signs or overhead fans. Choose from a variety of styles from pull chains, push-button and rotating actuators.



Scan for pricing or go to www.delcity.net/catalogpricing



7800007



7800010



7800012

Special Note

Add a **7900021** cloth pull cord to extend pull chain length.

Figure 1

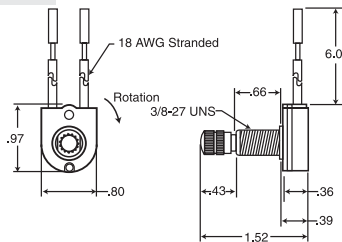

Recommended mounting hole: 13/32" dia.
6A/125V AC
3A/250V AC

Figure 2

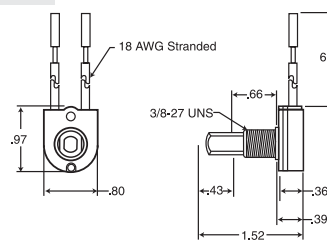

Recommended mounting hole: 1/2" dia.
6A/125V AC
3A/250V AC

Figure 3

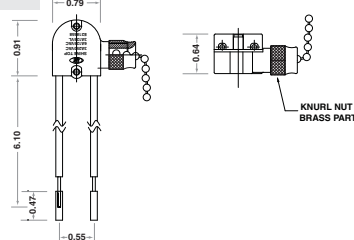

Recommended mounting hole: 13/32" dia.
6A/125V AC
6A/125 VL
3A/250V AC

Figure 4

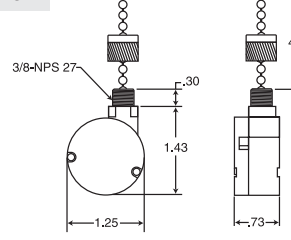

Recommended mounting hole: 13/32" dia.
6A/125V AC
6A/125 VL
3A/250V AC

non-illuminated canopy switches

Refer to drawings above for dimensions					actuator description	hardware	part no.	figure style
poles	circuit							
	A	B	C	D				
S.P.S.T.	ON	—	OFF	—	rotary	brass (nut & knob)	7800007	fig. 1
S.P.S.T.	ON	—	OFF	—	push-button	brass (nut & knob)	7800010	fig. 2
S.P.S.T.	ON	—	OFF	—	push-button	nickel (nut & plastic knob)	7800013	fig. 2
S.P.S.T.	ON	—	OFF	—	leaded pull chain	brass (nut & pull chain)	7800001	fig. 3
S.P.S.T.	ON	—	OFF	—	leaded pull chain	brass (nut & pull chain)	7800002	fig. 3
S.P.S.T.	ON	—	OFF	—	leaded pull chain	nickel (nut & pull chain)	7800021	fig. 3
S.P.S.T.	OFF	ON	ON	—	fan pull chain	brass (nut & pull chain)	7800012	fig. 4
S.P.3.T.	OFF	ON	ON	ON	fan pull chain	brass (nut & pull chain)	7800019	fig. 4
—	—	—	—	—	6' cotton thread cord	bronze (chain clip & bell)	7900021	—

Call 800.654.4757 for volume pricing and other hardware configurations

circuit breakers

Circuit Breakers



Scan for pricing or go to www.delcity.net/catalogpricing

Stud Mount ATC Blade Maxi Blade

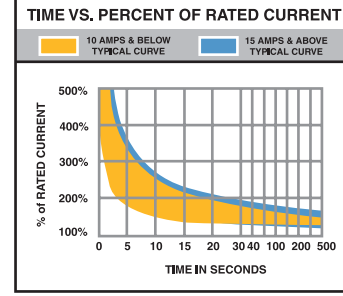
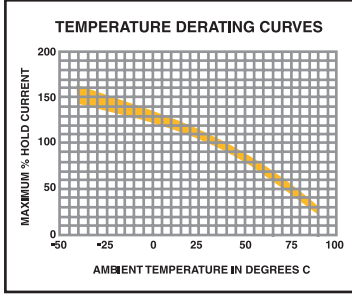
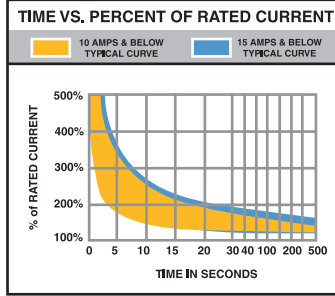
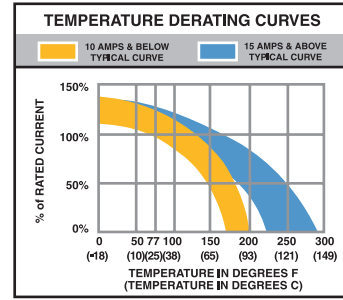
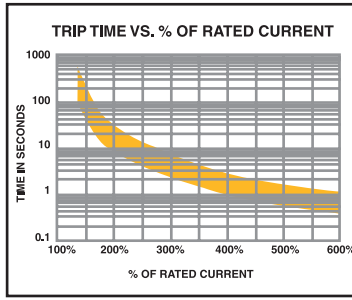
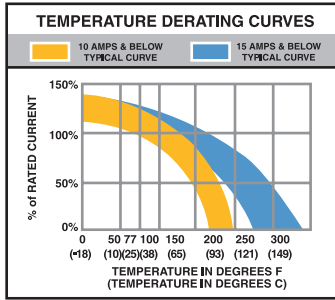

PAGES 133-134

PAGE 135

PAGES 135

Mini Blade Push Button Hi Amp

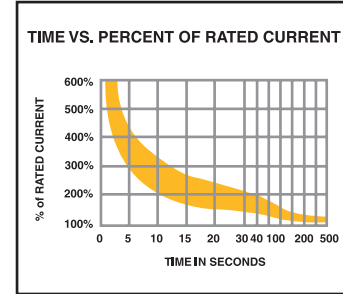
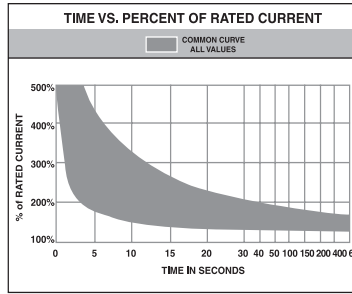
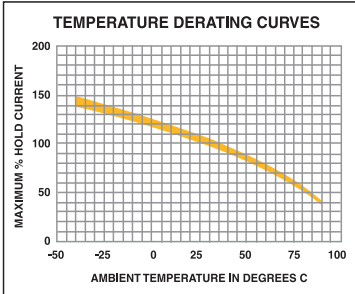
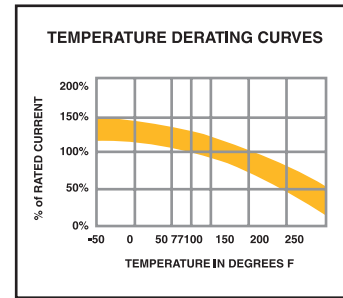
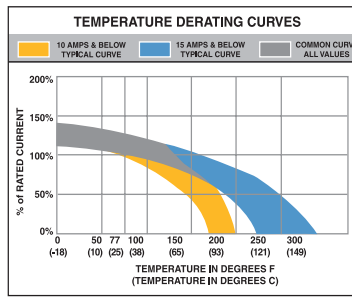
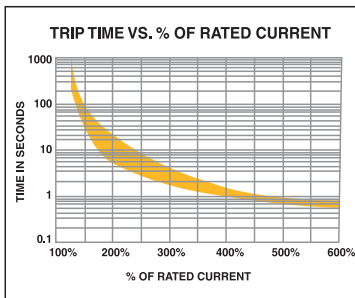

PAGE 136

PAGE 136

PAGES 138-139

Circuit Breakers – Stud Mount



Scan for pricing or go to www.delcity.net/catalogpricing

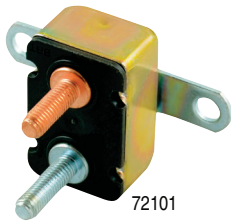

72101



72302

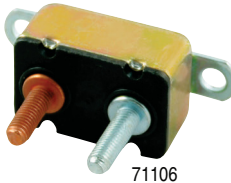

71106

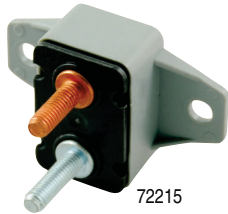

72215



71122

Type 1 – 12V DC Automatic Reset

This series of circuit protectors is comprised of single pole, thermal type breakers. Used in many diverse applications including multiple power outlet strips, trucks, buses, portable generators, welding equipment and trolling motors. Operating temperature is between -40°C to 85°C, (40°F to 185°F). Storage temperature is -40°C to 125°C (-40°F to 260°F). All Type 1, 2 and 3 circuit breakers are engineered for dependability. Nuts and washers included, all meet SAE J553 and SAE J1171 specifications.

INFORMATION

Stud Terminals: Two 10/32 stud; .66 (AUX) .50 (BATT)
Mounting Hole: .196 diameter holes

metal with horizontal mounting bracket

part no.	amp	part no.	amp
72101	5	72075	25
72102	6	72135	30
72105	10	72145	35
72115	15	72165	40
72125	20	72175	50

plastic with horizontal mounting bracket (splash/dust proof)

part no.	amp	part no.	amp
72215	10	72245	25
72225	15	72255	30
72235	20	72275	40

metal without mounting bracket

part no.	amp	part no.	amp
72302	6	72365	25
72305	10	72335	30
72315	15	72345	40
72325	20	72385	50

plastic with parallel mounting bracket (splash/dust proof)

part no.	amp	part no.	amp
71122	10	71128	25
71124	15	71130	30
71126	20	71132	40

metal with parallel mounting bracket

part no.	amp	part no.	amp
71100	5	71114	30
71106	10	71116	35
71108	15	71118	40
71110DL	20	71120	50
71112DL	25		

FUNCTION CODE

TYPE 1 – Automatic Reset

Will recycle continuously during an overcurrent condition. The composite alloy material will deflect and separate the contacts when an over-current situation occurs and returns to the run mode as it cools. The process will continue until the source of the overcurrent is removed or corrected.

TYPE 2 – Modified Reset

Circuit breaker will remain tripped (in the OFF position) as long as there is power to the circuit. Contains internal resistor. Reset circuit breaker by turning off the circuit or by turning off the ignition switch.

TYPE 3 – Manual Reset

Circuit breaker will remain tripped (in the off position) until indicator button or lever is manually reset to activate circuit. Type 3 available in plastic only.

Stud Mount Circuit Breaker Boot

Protect the electrical connection to the circuit breaker. Install the boot to keep out moisture, dust and other foreign debris. Designed to work with both metal and plastic breakers, with or without mounting brackets. Manufactured from polyvinyl chloride (PVC) material.

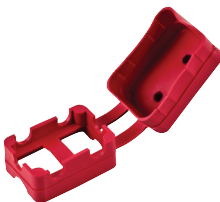

part no.	description
907201	red stud type boot

Type 1 – 24V DC Automatic Reset

metal with horizontal mounting bracket

part no.	amp	part no.	amp
72002	10	72010	30
72006DL	20	72114	40

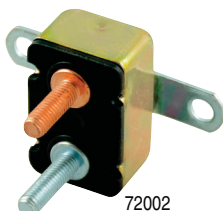

72002

circuit breakers

Circuit Breakers – Stud Mount cont.

Type 2 – 12V DC Modified Reset

Ideal for the recreational vehicle industry. Meets RVIA and SAE J553 specifications. Temperature range: operating -23°C to 65°C (-10°F to 150°F); storage -29°C to 93°C (-20°F to 200°F). Nuts and washers included.

metal with horizontal mounting bracket

part no.	amp	part no.	amp
72705	10	72735	30
72715	15	72745	40
72725	20	72755	50

metal with parallel mounting bracket

part no.	amp	part no.	amp
71134	10	71140	30
71136	15	71142	40
71138	20	71144	50

metal without mounting bracket

part no.	amp	part no.	amp
72805	10	72835	30
72815	15	72845	40
72825	20	72855	50

Type 3 – 12–24V DC Manual Reset

Ideal for marine and recreational vehicle applications. Meets RVIA and SAE J553 specifications. Temperature range: operating -23°C to 65°C (-10°F to 150°F); storage -29°C to 93°C (-20°F to 200°F). Nuts and washers included.

plastic with horizontal mounting bracket

part no.	amp	part no.	amp
75105	10	75135	30
75115	15	75145	40
75125	20	75155	50

plastic with parallel mounting bracket

part no.	amp	part no.	amp
71146	10	71152	30
71148	15	71154	40
71150	20	71156	50

plastic without mounting bracket

part no.	amp	part no.	amp
75215	15	75245	40
75225	20	75255	50
75235	30		

Mounting Brackets for Stud Mount Circuit Breakers

Circuit breakers snap into this mounting bracket with no tools needed. It accommodates metal SAE Type 1 and Type 2 breakers without mounting brackets. The bracket is manufactured with heavy gauge steel and holds breakers securely.

part no.	gang	dimensions
72025	2	3 ⁵ / ₈ " x 1 ⁵ / ₁₆ "
72045	4	6 ⁵ / ₈ " x 1 ⁵ / ₁₆ "
72065	6	8 ⁷ / ₁₆ " x 1 ⁵ / ₁₆ "
72066	8	10 ¹ / ₄ " x 1 ⁵ / ₁₆ "



Scan for pricing or go to www.delcity.net/catalogpricing



72715



72805

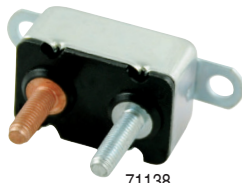

71138



75105



75205



71146



72045

Circuit Breakers – Blade

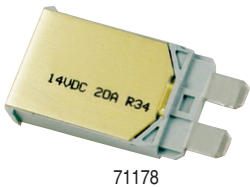

71178



72515

Type 1 and Type 3 – ATC® Type

These are single pole thermal-type breakers, 14V DC (Type 3 – 24V DC). They feature a UL rated 94VO thermoplastic housing with standard gold cover (Type 1) or silver cover (Type 3). Markings include amp/volt ratings. Meets SAE J553 and SAE J1171 specifications. Temperature range: operating -40°C to 85°C (-40°F to 185°F). Compatible with 280 Type or ATC® fuse blocks.

type 1

part no.	amp	part no.	amp
71174	10	71180	25
71176	15	71182DL	30
71178	20		

type 3

part no.	amp	part no.	amp
72505	10	72525	20
72515	15	72535	30

INFORMATION

Blade Terminal: .206" Q-C .51" long (Straight Auto) / Bushing: 7116-28 x .500 Molded

Type 3 – Low Profile ATC®/ATO® Type

These are single pole thermal-type breakers. The low profile allows for installation where space is a concern. Each is color-coded to amp rating. Markings include both volt and amperage ratings. Breakers meet SAE J553 and SAE J1171 specifications and are compatible with Del City ATC®/ATO® fuse panels. Temperature range: operating -40°C to 85°C (-40°F to 185°F). Rated up to 28V DC. Storage temp: -40°C to 125°C (-40°F to 260°F). UL rated 94VO thermoplastic body. Tin-plated copper alloy terminals.



75910

type 3

part no.	amp	part no.	amp
75910	10	75925	25
75915	15	75930	30
75920	20		

Type 1 – ATC®/ATO® Maxi™ Blade Type

This is a single pole thermal-type breaker with ATC®/ATO® blade configuration. Gray 94VO thermoplastic housing. Temperature range: -40°C to 85°C (-40°F to 185°F). Storage temp: -40°C to 125°C (-40°F to 260°F) 12V DC. Meets SAE J553 and SAE J1171. Compatible with fuse blocks accepting MAXI® or ATC/ATO blade fuses.



72625

part no.	amp	type
72605	10	auto reset
72615	15	auto reset
72625	20	auto reset
72635	30	auto reset

Type 1 – Maxi™ Auto Reset

Temperature range: -29°C to 65°C (-20°F to 150°F). Interchangeable with Maxi™ blade fuse. 12V DC. Meets SAE J553.



71330

part no.	amp	part no.	amp
71310	10	71330	30
71315	15	71340	40
71320	20	71350	50



Scan for pricing or go to www.delcity.net/catalogpricing

FUNCTION CODE

TYPE 1 – Automatic Reset

Will recycle continuously during an overcurrent condition. The composite alloy material will deflect and separate the contacts when an over-current situation occurs and returns to the run mode as it cools. The process will continue until the source of the overcurrent is removed or corrected.

TYPE 2 – Modified Reset

Circuit breaker will remain tripped (in the OFF position) as long as there is power to the circuit. Contains internal resistor. Reset circuit breaker by turning off the circuit or by turning off the ignition switch. Silver in color.

TYPE 3 – Manual Reset

Circuit breaker will remain tripped (in the off position) until indicator button or lever is manually reset to activate circuit.

circuit breakers



Scan for pricing or go to www.delcity.net/catalogpricing



71162



71170

Type 1 – Mini® Blade Type

Single pole thermal-type breakers, 14V DC. Housing is gray UL rated 94VO thermoplastic housing with metal cover. Standard gold cover (Type 1) or silver cover (Type 2). Markings include amp/volt ratings. Meets SAE J553 specifications for Type 1 and Type 2 circuit breakers. Temperature range: operating -40°C to 85°C (-40°F to 185°F). The terminals are compatible with 280 fuse blocks.

type 1				type 2			
part no.	amp	part no.	amp	part no.	amp	part no.	amp
71158	10	71162	20	71166	10	71170	20
71160	15	71164	25	71168	15	71172	25



71196

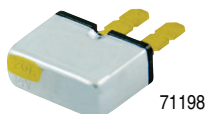

71198

Type 2 – Universal Circuit Breaker Connectors

"Snap-off" design of blades allows installer to size the blades for the application. Color-coded markings to match the color coding for ATC®/ATO® fuses (UCB-10-Red, UCB-15-Blue, UCB-20-Gold and UCB-30-Green). Fits standard ATC®/ATO® fuse panels. Conforms to J553C standard.

part no.	color	amp	part no.	color	amp
71194	red	10	71198	gold	20
71196	blue	15	71200	green	30

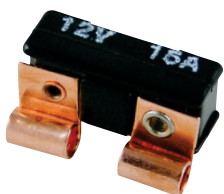

72425

Snap-in Circuit Breakers/AGC® Type

Remote reset circuit breaker replaces round glass-style fuses in existing fuse blocks. It opens automatically on overload, and remains open for protection until the trouble is corrected. Snap-in mounting in standard fuse clips. 1/4" diameter x 1-1/4" long. 12V DC.

part no.	amp	part no.	amp
72415	10	72435	20
72425	15		



70505



70545

1/4" Quick Connect – Push Button

Single pole thermal type. Operating temperature: -10°C to 60°C (-14°F to 140°F). Approvals: UL, CVL, TUV, CE UL1500/ISO8846 for ignition protection/marine. Applications: Household appliances, transportation, marine, power strips, medical equipment, audio, visual equipment, power supplies. Dielectric strength: 2500 VAC/1 minute. Interrupting capacity: 2500 amps@32VDC. Insulation resistance: 100M ohms. Rated to 32V DC, 125-250V AC.

without boot				NEW with boot			
part no.	amp	part no.	amp	part no.	amp	part no.	amp
70505	10	70520	40	75045	10	70550	40
70515	15	70530*	50	70555	15	70560*	50
70525	20	70540*	60	70565	20	70570*	60
70535	30			70575	30		

* 50 and 60 amp breakers have screw terminals

Mid-Range Circuit Breakers

A sleek rounded design houses this new class of thermal circuit breakers. They are manufactured for medium-duty chassis and marine applications, and meet the ignition protection standards per SAE J1171. Breakers are compliant with SAE J553 and carry a 2.5kA circuit interrupt protection rating per ABYC E-11. Body is made of UL-rated 94V-0 thermoset plastic and cover is made from 94V-0 thermoplastic with an elastomer over mold and gasket to provide it with a weatherproof IP66 rating. Mounting holes are .198" clearance and power studs are #10-32 threaded studs (nuts included). Breakers are designed to operate in temperatures between -40°F to 185°F.



Scan for pricing or go to www.delcity.net/catalogpricing

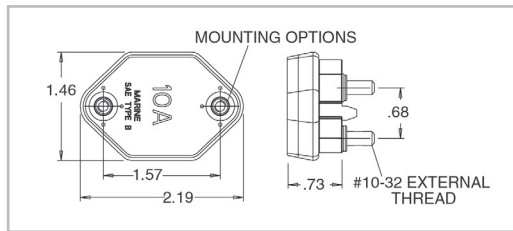

76730

Type 1 – Automatic Reset

These breakers will continuously cycle during a thermal over current condition. Rated up to 32V DC.

part no.	amp	part no.	amp
76730	30	76750	50
76740	40		

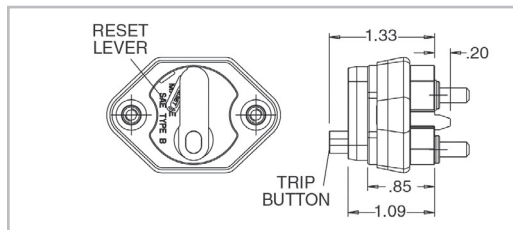

76940

Type 3 – Manual Reset (Switchable)

These breakers will trip (lever extends to the open position) under a thermal over current condition and remains tripped until the lever is manually reset, closing the circuit. This series also offers the unique feature of a push-to-trip button, to allowing you to manually disconnect the circuit. Rated up to 32V DC.

part no.	amp	part no.	amp
76930	30	76950	50
76940	40		

circuit breakers

Hi-Amp Panel Mount Circuit Breakers

This series of circuit breakers are typically used in auxiliary and accessory circuits within trucks, buses, recreational vehicles and marine applications. Breakers are compliant with SAE J1625 and carry a circuit interrupt protection rating of 3,000A at 30V DC per ABYC E-11. Body is made of UL-rated 94V-0 thermoset plastic and cover is made from 94V-0 thermoplastic with an elastomer over mold and gasket to provide it with a weatherproof IP66 rating. Mounting holes are .260" clearance and power studs are 1/4"-28 threaded studs (nuts included). Breakers are designed to operate in temperatures between -40°F to 185°F.

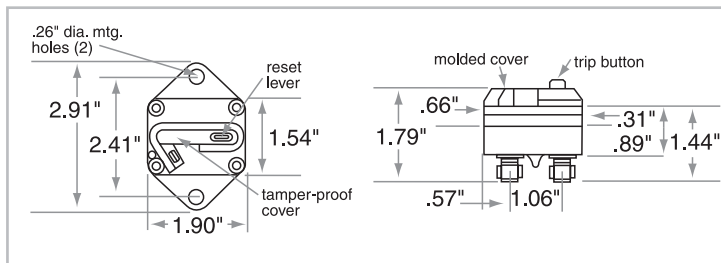

Type 1 – Automatic Reset

These breakers will continuously cycle during a thermal over current condition. Each breaker is rated up to 30V DC.



part no.	amp	part no.	amp
76365	60	76305	100



Type 3 – Manual Reset (switchable)

These breakers will trip (lever extends to the open position) under a thermal over current condition and remains tripped until the lever is manually reset, closing the circuit. This series also offers the unique feature of a push-to-trip button, allowing you to manually disconnect the circuit. Each breaker is rated up to 42V DC.

part no.	amp	part no.	amp
76265	60	76205	100

Gasket for Panel Mount Circuit Breaker

Gasket wraps around breaker to provide a seal between the circuit breaker housing and the panel it is being installed into.



part no.	description
8000275	gasket for panel mount circuit breaker



Scan for pricing or go to www.delcity.net/catalogpricing

circuit breakers

Hi-Amp Surface Mount Circuit Breakers

This series of circuit breakers are typically used in auxiliary and accessory circuits within trucks, buses, recreational vehicles and marine applications. Breakers are compliant with SAE J1625 and carry a circuit interrupt protection rating of 3,000A at 30V DC per ABYC E-11. Body is made of UL-rated 94V-0 thermoset plastic and cover is made from 94V-0 thermoplastic with an elastomer over mold and gasket to provide it with a weatherproof IP66 rating. Mounting holes are .260" clearance and power studs are 1/4"-28 threaded studs (nuts included). Breakers are designed to operate in temperatures between -40°F to 185°F.



Scan for pricing or go to www.delcity.net/catalogpricing

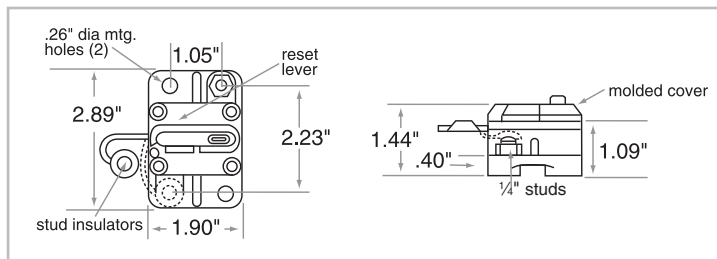

76410

Type 1 – Automatic Reset

These breakers will continuously cycle during a thermal over current condition. Rated up to 30V DC.

part no.	amp	part no.	amp
76405	60	76420	120
76410	90	76430	150
76415	100		



76505

Type 3 – Manual Reset

These breakers will trip (lever extends to the open position) under a thermal over current condition and remains tripped until the lever is manually reset, closing the circuit. Each breaker is rated up to 42V DC.

part no.	amp	part no.	amp
76505	60	76520	120
76510	90	76530	150
76515	100		



76615

Type 3 – Manual Reset (switchable)

These breakers will trip (lever extends to the open position) under a thermal over current condition and remains tripped until the lever is manually reset, closing the circuit. This series also offers the unique feature of a push-to-trip button, allowing you to manually disconnect the circuit. Each breaker is rated up to 42V DC.

part no.	amp	part no.	amp
76600	30	76610	90
76602	50	76615	100
76605	60	76620	120
76608	80	76630	150

circuit breakers

Marine Rated Circuit Breakers (Better Disconnect)

This series of circuit breakers allows for the same protection of a high amperage circuit breaker, with an added function of a On/Off power switch that is rated up to 3,000 cycles and allows you to manually disconnect the circuit. Each thermal type breaker's body is made of UL-rated 94V-0 thermoset plastic and the cover is made from 94V-0 thermoplastic with an elastomer over mold and gasket to provide it with an IP66 rating allowing them to be marine rated or weatherproof. Available in both panel and surface mount styles and in amperage ratings ranging from 60 to 150 amps. Rated up to 48V DC, each breaker is compliant with ABYC E-11, CE, SAE J1171 for ignition protection and for operating temperatures of -40°F to 185°F. Mounting holes are .215" clearance and countersunk .161". Power studs are 5/16"-18 threaded studs (nuts included).



Scan for pricing or go to www.delcity.net/catalogpricing

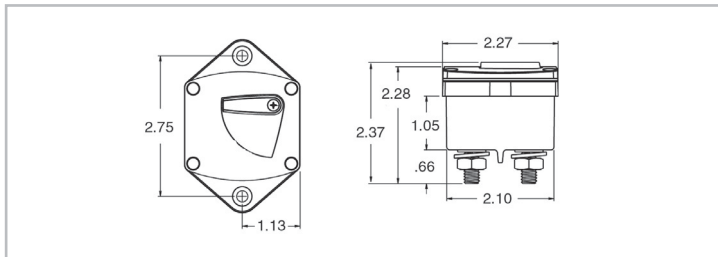

Type 3 – Manual Reset, Panel Mount

These panel mount circuit breakers will trip (lever extends to the Off position) under a thermal over current condition and remains tripped until the lever is manually reset to On, closing the circuit. Breakers are rated up to 48V DC.

part no.	amp	part no.	amp
88060DL	60	88100	100
88080	80		

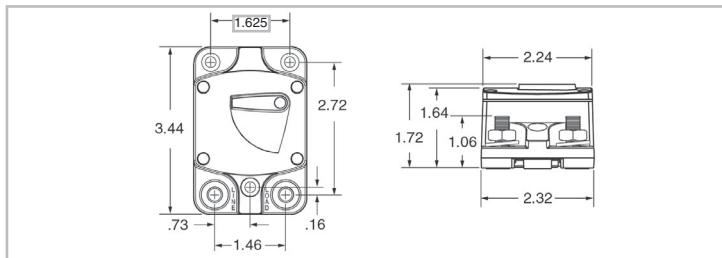

Type 3 – Manual Reset, Surface Mount

These surface mount circuit breakers will trip (lever extends to the Off position) under a thermal over current condition and remains tripped until the lever is manually reset to On, closing the circuit. Breakers are rated up to 48V DC.

part no.	amp	part no.	amp
82060	60	82120	120
82090	90	82150	150
82100	100		

fuses & fuse accessories

AGC®, ATO®, ATC®, Mini® and Maxi™ Fuses

Used in most domestic and imported cars. Meets or exceeds OEM and SAE standards.



Scan for pricing or go to www.delcity.net/catalogpricing

INFORMATION

IMPORTANT:

Voltage must match or exceed the fuse being replaced (125V for household current; 12V for auto; 24V for heavy-duty). Must match amperage of the old fuse.

Amp rating	Color	Amp Rating	Color
2	gray	10	red
3	violet	15	lt. blue
4	pink	20	yellow
5	tan	25	natural
7.5	brown	30	green

AGC® Fuses

These fast-acting all glass fuses solve a broad range of application requirements while offering reliable performance and cost-effective circuit protection. Temperature rating: -55°C to 125°C.

1/4" x 1 1/4"



79815



79785

part no.	amp	part no.	amp
79815	3	79855	15
79807	5	79825	20
79865	6	79808	25
79875	7.5	79835	30
79885	8	79809	35
79805	10		

rated to 32 volts
bulk – min. 100 pcs.

part no.	description
79785	AGC® fuse, .250 tap-in bulk – min. 100 pcs.

ATO® Fuses with Indicator Light

Specialty automotive type fuses with an innovative indicator light that glows when the fuse is blown. Designed to be drop-in replacements for existing automotive applications. Helps with hard-to-find blown fuses, in dimly-lit dashboards or under the hood of automobiles.



78105



88815



78025

without indicator light

part no.	amp	part no.	amp
78035	3	78205	20
78055	5	78255	25
78075	7.5	78305	30
78105	10	78406	40
78155	15		

rated to 32 volts

with Indicator light

part no.	amp	part no.	amp
88833	3	88815	15
88805DL	5	88820	20
88875	7.5	88825DL	25
88810DL	10	88830	30

rated to 32 volts
bulk – min. 10 pcs

part no.	description
78025	ATC®/ATO® fuse, .250" tap-in

bulk – min. 100 pcs.

Use With

fuse holder
PAGE 145-146

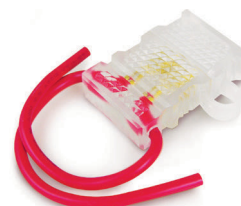

fuses & fuse accessories



Scan for pricing or go to www.delcity.net/catalogpricing



78502



78521

Maxi® Fuse

Maxi® fuses feature "diffusion pill technology" and provide excellent time delay characteristics and low heat dissipation. These fuses are ideal for motor powered applications. Temperature rating: 40°C to 125°C. Terminals: Silver plated zinc alloy. Housing material: PA66 AW J1888.

Maxi® Fuse

part no.	amp	part no.	amp
78501	20	78504	50
78506	25	78505	60
78502	30	78507	70
78503	40	78508	80

rated to 32 volts
bulk – min. 10 pcs.

NEW Maxi® Indicator Fuse

part no.	amp	part no.	amp
78520	20	78524	60
78521	30	78525	70
78522	40	78526	80
78523	50	78527	100

Mini® Fuse

Mini® Fuses temperature rating: -40°C to 125°C. Terminals: silver plated zinc alloy. Housing Material: PA66 SAE J2077. Mini® Indicator Fuses are standard Mini® fuses with a clear epoxy top for immediate recognition of a blown fuse. When the fuse is blown, the top will glow, saving time to troubleshoot an open circuit. Rated up to 12 volts DC at an operating temperature of -40°C to 125°C. Interruption rating is 1000A at 14 VDC. Terminals are silver plated Zinc alloy.

Mini® Fuse

part no.	amp	part no.	amp
77015	2	77105	10
77035	3	77155	15
77045	4	77205	20
77055	5	77255	25
77075	7.5	77305	30

rated to 32 volts
bulk – min. 10 pcs.

Mini® Fuse low profile

part no.	amp	part no.	amp
87005	5	87020	20
87075	7.5	87025DL	25
87010	10	87030	30
87015	15		

rated to 58V DC



77155



87075



77025



77475

Mini® tap-in

part no.	description
77025	Mini® .187 tap-in

NEW Mini® Indicator Fuse

part no.	amp	part no.	amp
77403	3	77415	15
77405	5	77420	20
77475	7.5	77425	25
77410	10	77430	30

NEW

Micro2 Fuses



Micro2 fuses are the new standard for vehicle circuit protection. Their sub-miniature design meets the need for more circuits to be protected while utilizing less space. Micro fuses are ideal for high temperatures in adverse environments. Terminals are Ag plated zinc alloy. Offered sizes include: 5, 7.5, 10, 15, 20, 25 and 30 Amp. These fuses have an operating temperature of -40°C to 125°C. Rated up to 32V DC.

part no.	amp	part no.	amp
78905	5	78920	20
78975	7.5	78925	25
78910	10	78930	30
78915	15		

bulk – min. 10 pcs.

NEW

Micro3 Fuses

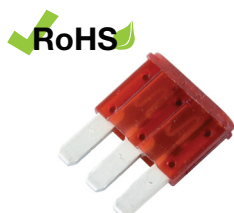

Micro3 Fuses have 3 terminals and 2 fuse elements with a common center terminal. Their sub-miniature design meets the need for more circuits to be protected while utilizing less space. Rated up to 32 volts DC at an operating temperature of 40°C to 125°C. Interruption rating is 1000A at 32 VDC. Terminals are silver plated zinc alloy. The housing material is PA66.

part no.	amp	part no.	amp
78931	5	78933	10
78932	7.5	78934	15

bulk – min. 10 pcs.

NEW

MCASE™ Fuses



The MCASE™ is a cartridge fuse with female terminals for 2.8 mm male terminals. It has a miniaturized footprint for optimal usage of space. It is a time delayed fuse and can handle inrush currents. Rated up to 32 volts DC at an operating temperature of 40°C to 125°C. Interruption rating is 1000A at 32 VDC. Insertion force is 44.1N maximum (9.9 lbs). Extraction force is 4N minimum (0.9 lbs), 24.5N maximum (5.5 lbs).

part no.	amp	part no.	amp
79630	15	79633	30
79631	20	79634	40
79632	25		



Scan for pricing or go to www.delcity.net/catalogpricing

High Amp Fuses and Fusible Links

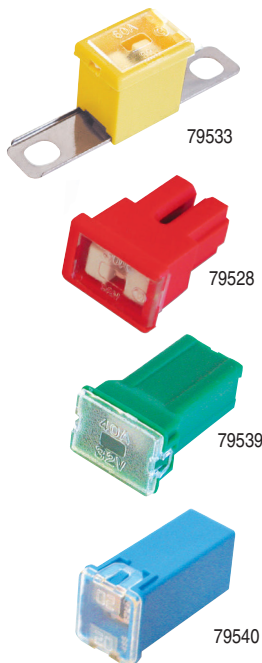

These fuses were designed to be used as replacements for fusible links. Their female oriented connection terminals provide a replacement benefit over typical blade type fuses, which sometimes wear out fuse panels after repetitive insertion/replacement. The JCASE® series are cartridge style fuses with a female terminal design JCASE® provides both increased time delay and low voltage drop to protect high current circuits. The JCASE® series can be used with fuse holder 79610. Each fuse features an increased time delay and low voltage drop protection rated up to 32V DC. Operating range: -40°C to 125°C (-40°F to 257°F). Meets JA50 0612

PAL bolt-mount

part no.	color	amp
79530	pink	30
79531	green	40
79532	red	50
79533	yellow	60
79534	brown	70
79535	black	80
79536	blue	100
79537	lt. gray	120

PAL female

part no.	color	amp
79525	lt. blue	20
79526	pink	30
79527	green	40
79528	red	50
79529	yellow	60

PAL mini female

part no.	color	amp
79538	pink	30
79539	green	40

JCASE® female

part no.	color	amp
79540	lt. blue	20
79541	pink	30
79542	green	40
79543	red	50
79544	yellow	60

Low Profile Cartridge Fuses



JCASE® low profile fuses have similar performance characteristics as the standard JCASE® fuse. The lower overall height reduction allows for more space and weight savings. Fuses are designed with female terminals to help reduce typical replacement wear on your vehicle's fuse box. Low profile fuses have operating temperatures of -40°C to 125°C. Rated up to 58V DC.

FMX/JCASE® female low-profile

part no.	color	amp	part no.	color	amp
79625	blue	20	79627	green	40
79635	natural	25	79628	red	50
79626	pink	30	79629	yellow	60

MEGA® Fuses



MEGA® fuses are ideal for battery and alternator protection applications and heavy gauge cables that require ultra-high current protection. Mounting holes are .340" diameter and spaced 2" apart. Recommended fuse holder: 87900 and 87905. Rated up to 32 volts DC at an operating temperature of 40°C to 125°C (-40°F to 57°F).

part no.	amp	part no.	amp	part no.	amp
87100	100	87200	200	87350	350
87125	125	87225	225	87400	400
87150	150	87250	250	87451	450
87175	175	87300	300	87500	500

bulk - min. 1 pcs.

fuses & fuse accessories



Scan for pricing or go to www.delcity.net/catalogpricing



Mini® Fuse Kit

Organization that fits in the palm of your hand. This kit contains 80 total pieces of eight different color-coded, fast acting, Mini® fuses. 10 pieces each of 4–30 amp fuses. All contained within a durable, lightweight and translucent plastic carrying case (4-1/2" x 2-5/8" x 1-5/16"). **For a complete listing of kit contents, see page 326.**

part no.	description	pieces
305	Mini® fuse kit	80



ATO® Fuse Kits

Our fuse kits offer an excellent combination of fuses so that you are always prepared. These fuses are a convenient and inexpensive way to protect your circuits. Kit no. 303 contains an assortment of 160 ATC/ATO® fuses ranging from 3 amps to 30 amps in a 12-compartment plastic box (7 1/4" x 6" x 1 1/8"). Kit no. 304 contains an assortment of 80 ATC/ATO® fuses ranging from 3 amps to 30 amps inside an 8-compartment plastic box (5" x 4 1/4" x 1 1/4"). **For a complete listing of kit contents, see pages 325-326.**

part no.	description	pieces
303	ATO® fuse kit	160
304	ATO® fuse kit	80



The SafeGard™ Multi Fuse Kit

Contains the most popular ATC/ATO®, Mini® and AGC® fuses and fuse holders. A variety of amps are included giving you more options for circuit protection. All contained within a durable, lightweight and translucent plastic carrying case (11" x 6 3/4" x 1 3/4").

For a complete listing of kit contents, see pages 326.

part no.	description	pieces
306	SafeGard™ multi fuse kit	203



Multi Fuse Kit

This ATO fuse kit provides a convenient and economical way to protect your circuits. The kit is small enough for easy handling and contains an assortment of ATO® and Mini™ fuses ranging from 5A to 30A and tap-ins inside a convenient carrying case (4-1/2"x2-5/8"x1-5/16").

For a complete listing of kit contents, see pages 326.

part no.	description	pieces
307	multi fuse and tap-in kit	180

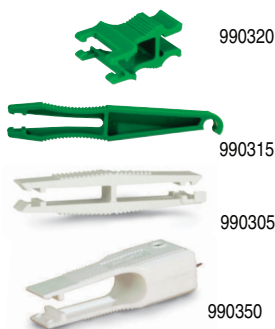

Fuse Pullers

Designed for ease of use. Extract AGC®, ATC®, ATO®, mini or maxi fuses from various fuse blocks.

part no.	description
990320	Maxi™ fuse puller
990315	ATC®/ATO®/AGC® fuse puller
990305	ATC®/ATO®/Mini™ fuse puller
990350	ATC®/ATO®/Mini® fuse puller
990370	ATC®/ATO®/AGC®/Ceramic/Mini® fuse puller
990375	JCASE® fuse puller

bulk – min. 1 pcs.

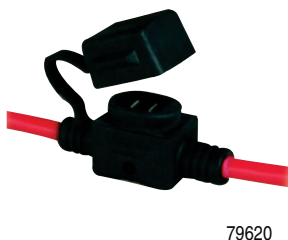

JCASE® Fuse Holders

Designed to be used with the standard and low profile JCASE® fuses, these fuse holders provide a weatherproof housing and fusible connection to any electrical systems up to 58V DC. Each holder has a molded/attached cover with 4" wire leads (wire color may vary). Rated up to 60 amps.

part no.	description
79610	standard w/cover, 8 AWG
79620	low profile w/cover, 8 AWG



AGC® Nylon In-line Fuse Holders

Fuse holders with molded nylon bodies are furnished with one fuse (fuse not assembled inside). Made with standard 8" GPT wire. 6–10 amp = 14 gauge wire leads, 15–30 amps = 12 gauge wire leads. Wire color is red. Holder rated to 32V DC.

part no.	amp	gauge	part no.	amp	gauge
79115	no fuse	14	79145	no fuse	12
79165	6	14	79155	15	12
79185	8	14	79125	20	12
79105	10	14	79135	30	12



Scan for pricing or go to www.delcity.net/catalogpricing



AGC® In-line Fuse Holders

Heavy-duty backlite in-line fuse retainer. Made with standard 6" GPT wire. Fuse included. Wire color is red. Holder rated to 250V DC.

part no.	amp	gauge
79010	5	18
79020	20	14
79030	35	10



AGC® Adjustable Fuse Holder

Two-piece molded fuse holder accepts 18–12 gauge wire. The fuse holder snap locks together for AGC® fuse size 1/4" diameter x 1-1/4". Made of nylon and bright yellow in color. Pull force: 5 lbs min. to separate fuse holder housing with fuse installed. Crimp to hold wire in place. UL flammability rating 94V-2. Holder rated 32V DC.

part no.	amp	gauge
79055	30	18–12



AGC® Weather Resistant Fuse Holder

One piece molded thermoplastic fuse holder accepts wire sizes 18–12 gauge and is not weather resistant if used with other wire sizes. -40°C to 150°C (-40°F to 302°F) temperature range applies to the fuse holder only. Fuse holder can be written on to indicate circuit. The bright yellow color makes the fuse holder easy to locate. For 1/4" x 1-1/4" AGC® fuses. Fuse not included. Crimp to hold wire in place. Holder rated 32V DC.

part no.	amp	gauge
79005	30	18–12



MEGA® Fuse Holder

Designed to be used with MEGA® Fuses, the MEGA® fuse holder features a protective cap, interconnecting pins on the side of the fuse block for multiple block configurations, M8 threaded studs and hex nuts with lock washers. Fuses sold separately.

part no.	description	amp
87900	MEGA® fuse holder w/cap	250
87905	MEGA® fuse holder w/cap	500



AGC® Fuse Retainer Panel Mount



Designed to mount in panel hole of .575" diameter. Two .187" male connection terminals. Rated to 250V AC-CSA. Fuse not included.

part no.	amp	gauge
79075	10	—

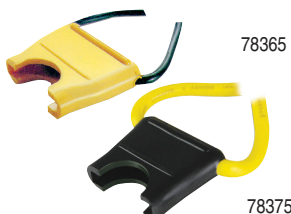

ATC®/ATO® Fuse Holder

"Write-in" space available to easily identify circuits. Manufactured with standard 3.5" GPT wire. Fuses not included. Holder rated to 32V DC.

part no.	amp	gauge	wire color
78365	20	16	black
78375	30	12	yellow

fuses & fuse accessories



Scan for pricing or go to www.delcity.net/catalogpricing



ATC®/ATO® Fuse Holder

A premium quality, insulated and weatherproof ATC® fuse retainer. Manufactured with 8.75", 12 gauge GPT wire. Fuse not included; wire color is orange. Holder rated to 32V DC.

part no.	amp	gauge
79001	30	12

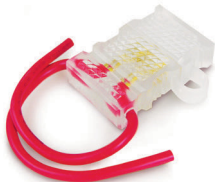

ATC®/ATO® Indicator Fuse Holder

For use with indicator fuses. Clear cover allows visibility of blown fuse. Manufactured with 4", 12 gauge 600V tinned wire. 20 amp maximum. Fuse not included; wire color may vary. Holder rated to 32V DC.

part no.	amp	gauge
79003	20	12



78330

ATC®/ATO® Fuse Holders

Deluxe water tight body with a water resistant cap. Manufactured with standard 6" GPT wire. Fuse not included; wire color is red. Holder rated to 32V DC.

part no.	amp	gauge
78310	10	16
78330	30	12
78335	35	10



ATC®/ATO® Converter

Converts one ATC®/ATO® fuse circuit into two fusible circuits. Simply plug into existing panel space and the two open spots on the converter allows for two new fuses to be separately protected up to 10 amps Fuses not included. Holder rated to 32V DC.

part no.	amp	gauge
79040	10	16

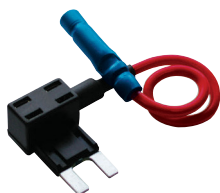

Mini® Fuse Converter

Converts a single Mini® fuse circuit into two separate fuse circuits. Simply plug into existing panel space and the two open spots on the converter allow for two new fuses to be separately protected up to 10 amps Holder rated to 32V DC.

part no.	amp	gauge
79045	10	16



Self-tapping ATC®/ATO® Fuse Holder

Self tapping design requires no wire stripping. No special tool is necessary; installs with common pliers. For use with 18–14 gauge wire, 20 amp maximum. Fuse not included. Holder rated to 32V DC.

part no.	amp	gauge
78355	20	18–14



Mini® Fuse Holder

The perfect weather resistant fuse holder designed for applications where moisture is a problem. Cap has a positive snap action for a tight fit. Manufactured with 4", 12 gauge UL 1015 wire, 30 amps. For Mini® fuse only (fuse not included); wire color is orange. Holder rated to 32V DC.

part no.	amp	gauge
78385	30	12



Maxi™ Fuse Holder

The perfect weather resistant fuse holder designed for applications where moisture is a problem. Cover includes a removable strap. Manufactured with standard 5", 6 gauge GPT wire. Range: 20 to 60 amps. Fuse not included; wire color is black. Holder rated to 32V DC.

part no.	amp	gauge
78515	60	6



Scan for pricing or go to www.delcity.net/catalogpricing

Sealed Mini® Fuse & ISO 280 Mini Relay Combo Panel, Partially Bussed Input



The sealed Mini® fuse and ISO 280 mini relay panel has two power distribution circuits. Circuit one is a bussed fuse way that accepts up to ten(10) Mini® fuses. Circuit two is a fuse/relay way that accepts up to ten(10) Mini® fuses or five(5) ISO 280 mini relays or a combination of each. It can be mounted either in a panel or in a surface mounted application when combined with 15303001 mounting brackets. Fuse and relay branches are rated up to 30 amp max. each branch, bussed M6 input studs are rated up to 80 amps (80A per side) max. and panel is rated to 100 amps (80A per side) max with relays or 160 amps max fuse only. Metri-Pack™ 280 tangless terminals seals and cavity plugs (sold separately).

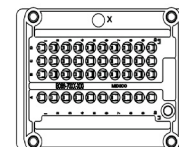

* bottom view

part no.	description
15303524	sealed Mini® Fuse & ISO 280 relay combo Panel

Sealed Mini® Fuse Panel with Bussed Inputs



The fuse panel has two bussed, power distribution circuits that accept up to ten (10) Mini® fuses on each side. The low profile cover allows for mounting in tight panel or surface spaces (surface mount requires Del City 15303001 mounting bracket). Fuse branches are rated up to 30A max. per branch, and the bussed M6 input studs are rated up to 80A max. Panel cannot exceed 160A (80A per side) max. fuse combination. Metri-Pack™ Sealed 280 tangless terminals and seals are sold separately.

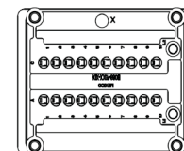

* bottom view

part no.	description
15303123	sealed Mini® fuse panel

Sealed Mini® Fuse & ISO 280 Mini Relay Panel with Bussed Inputs



This fuse panel is designed to accept up to ten (10) Mini® fuses on one side and up to five (5) mini ISO relays on the other side. The low profile cover allows for mounting in tight panel or surface spaces (surface mount requires Del City 15303001 mounting bracket). Both fuse and relay branches are rated up to 30A max per branch with bussed M6 studs rated up to 80A max. The panel is rated up to 100A (80A per side) max. Metri-Pack™ Sealed 280 tangless terminals and seals are sold separately.

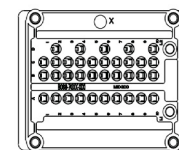

* bottom view

part no.	description
15303224	sealed Mini® fuse & relay panel

Sealed Mini® Fuse & ISO 280 Mini Relay Combo Panel with Individual Inputs



Apply power to each individual circuit on both sides of this fuse panel. One side accepts up to ten(10) Mini® fuses, the other side accepts up to ten(10) Mini® fuses or five (5) ISO 280 mini relays. It can be either panel or surface mounted (surface mount requires 15303001 mounting bracket). Fuse and relay branches are rated up to 30A max each branch, bussed M6 input studs are rated up to 80A max and the panel is rated to 100A (80A per side) max with relays or 160A (80A per side) max fuse only. Metri-Pack™ 280 tangless terminal seals and cavity plugs sold separately.

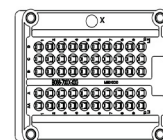

* bottom view

part no.	description
15303404	sealed Mini® Fuse & ISO 280 relay combo Panel

fuses & fuse accessories



Scan for pricing or go to www.delcity.net/catalogpricing

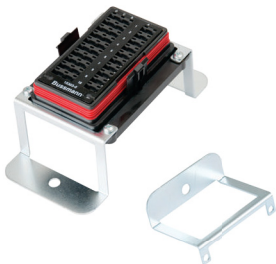

Mounting Bracket for Sealed Mini Fuse/ISO Relay Panels

The mounting bracket for sealed Mini Fuse/ISO Relay Panels allows it to be mounted to any surface. Two brackets are required to complete an assembly and each bracket is manufactured of steel with zinc plating.

part no.	description
15303001	Mounting Bracket for Sealed Mini® Fuse/ISO Relay Panels



Metri-Pack™ 280 Tangless Terminal and Seal Kit

The Metri-Pack™ 280 tangless kit provides all the essential Metri-Pack™ 280 tangless female terminals, seals and cavity plugs. This small kit ensures you have the inventory and is ideal for small projects. Components come in a convenient carrying case (4-1/2"x2-5/8"x1-5/16"). **For a complete listing of kit contents, see page 330.**

part no.	description	pieces
75052	Metri-Pack™ 280 Tangless Terminal and Seal Kit	425



Metri-Pack™ 280 Sealed Terminal and Seal Kit

The Metri-Pack™ 280 kit provides all the essential Metri-Pack™ 280 female terminals, seals and cavity plugs. This small kit ensures you have the inventory and is ideal for small projects. Components come in a convenient carrying case (4-1/2"x2-5/8"x1-5/16"). **For a complete listing of kit contents, see page 330.**

part no.	description	pieces
75053	Metri-Pack™ 280 Sealed Terminal and Seal Kit	425



908475



908485



908495



990174

Metri-Pack™ Tools

Designed for the positive crimping of Metri-Pack™ terminals. Quality tools for long-lasting and dependable service. Removal tool provides for easy removal of terminals. Ratchet assembly ensures a perfect crimp every time.

part no.	description	gauge	OEM #
908475	removal tool	—	12094429
908485	multi-gauge crimper	20–14	12155975
908495	crimper	12–10	12071687
990174	Weather Pack and Metri®-Pack 150 and 280 sealed crimper	22-14	-

ATC®/ATO® Fuse and Power Blocks

ATC® /ATO® Power Blocks are tailor-made blocks for power distribution systems. Included is a cover, a gasket inside the cover to help seal out dust and moisture, along with .250" male terminals for easy wiring connections. A tough, dependable product perfect for automotive, marine, off-road, agricultural equipment, van conversion, RV and other applications. Non-ganged, single circuit protection. Fuses not included.



Scan for pricing or go to www.delcity.net/catalogpricing

INFORMATION

OPERATING CHARACTERISTICS: Maximum 30 amps per branch, 65 amps maximum per block. Temperature rating: 85°C (185°F). 12–32V DC.



4-way Raised Fuse Block

A 4-way raised fuse block allowing 50 amp maximum for all branches combined. .250" male blade (bottom blade insertion). Mounting holes: center-to-center 2.095" (53.2mm). Mounting hole diameter .219" (5.5mm). Each fuse branch is independently powered.

part no.	description	max amp all combined
73801	4-way raised fuse block	50



6-way Raised Fuse Block

A 6-way raised fuse block allowing 65 amp maximum for all branches combined. .250" male blade (bottom blade insertion). Mounting holes: center-to-center 2.88" (73.2mm). Mounting hole diameter .219" (5.5mm). Each fuse branch is independently powered.

part no.	description	max amp all combined
73803	6-way raised fuse block	65



8-way Fuse Block

An 8-way panel mount fuse block allowing 80 amp maximum for all branches combined. .250" male blade (bottom blade insertion, reinforced screw holes). Mounting holes: center-to-center 4.055" (103mm). For mounting, cut opening 3.5" x 1.1" (89mm x 28mm). Mounting hole diameter .219" (5.5mm). Each fuse branch is independently powered.

part no.	description	max amp all combined
73805	8-way fuse block – panel mount	80

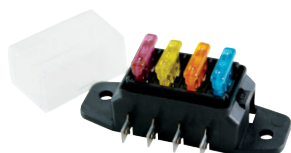

4-way Fuse Block

A 4-way fuse block allowing 50 amp maximum for all branches combined. .250" male blade (side blade installation). Mounting holes: center-to-center 2.56" (65mm). Mounting hole diameter .219" (5.5mm). Each fuse branch is independently powered.

part no.	description	max amp all combined
73810	4-way fuse block	50



6-way Fuse Block

A 6-way fuse block allowing 65 amp maximum for all branches combined. .250" male blade (side blade installation). Mounting holes: center-to-center 3.35" (85mm). Mounting hole diameter .219" (5.5mm). Each fuse branch is independently powered.

part no.	description	max amp all combined
73820	6-way fuse block	65

fuses & fuse accessories



Scan for pricing or go to www.delcity.net/catalogpricing



ATC®/ATO® Fuse Block

Black nylon 1-way fuse block has a clip slot for mounting with a .250" flat head screw. Brass terminals included. Rated for 30 amp maximum.

part no.	description	max amp
73885	1-way fuse block	30



ATC®/ATO® Fuse Block

Black nylon 4-way fuse block is stackable with bolt holes for mounting to a stationary object. Brass terminals included. Rated for 50 amp max for all branches combined. Includes one terminal strip and four individual terminals.

part no.	description	max amp all combined
73895	4-way fuse block	50



7389520



7388520

Terminals for Fuse Blocks

Brass terminals for fuse blocks offer quick dependable wiring connections. Works with 16–14 gauge wire.

part no.	description
7388520	single terminal for 1-way fuse block
7389520	terminal strip for 4-way fuse block

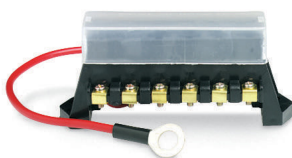

ATC®/ATO® Fuse Block

A 6-way ganged raised fuse block with a 22", 8 gauge hot wire. A screw terminal output and cover, with a .375" stud ring terminal attached. 30 amp max per branch. Rated for 65 amp max for all branches combined.

part no.	description	max amp all combined
73897	6-way fuse block	65



75805

Mini® Fuse Blocks

These surface mounted fuse blocks are rated up to 15 amps max per circuit at 12V DC. .250" male blade (side blade installation). Base material is nylon UL94V-0. Polycarbonate cover includes rubber gasket to help seal out debris. Each fuse branch is independently powered.

part no.	description	branch	mounting center-to-center	max amps per circuit
75800	Mini® fuse block	4	2.559"	15
75805	Mini® fuse block	6	3.346"	15
75810	Mini® fuse block	8	4.134"	15
75815	Mini® fuse block	10	4.528"	15

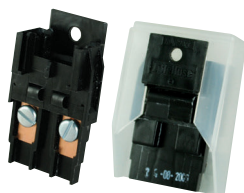

Maxi™ Fuse Block

This interlocking fuse block allows for 2-pole installation and is an ideal replacement for fusible link wire. Rated up to 60 amps maximum. Screw terminal wire mount. Fuse not included.

part no.	description	max amps
73886	Maxi™ fuse block	60
73887	Maxi™ fuse block cover	–

fuses & fuse accessories



Scan for pricing or go to www.delcity.net/catalogpricing



70165



70265

ATC®/ATO® Blade-type Fuse Panels

Compact, lightweight and rugged enough to use in recreational vehicles, trucks, buses and boats. These panels will accept ATC®/ATO® blade type fuses or blade type automatic or manual reset circuit breakers. Panels range from 6 to 12 branch protected circuits. Easy wiring with .250" quick connect branch circuit terminal and stud common ground or .250" quick connect, if preferred. No top cover is needed, recessed fuse contacts. Molded of high grade thermoplastic. Rated 0°C to 65°C (-20°F to 100°F), 105°C (221°F) with a UL rated 94V-0 thermoplastic body. Recessed mounting holes.

INFORMATION

ATO®/ATC® FUSE PANEL:

Common negative bus with "push-on" tabs.
Common positive feed.
Each branch handles up to 30 amps (160 amp maximum total).

ATC®/ATO® blade type fuse panel

part no.	position/branch	part no.	position/branch
70165	6	70105	10
70185	8	70125	12

fuse panel with grounding pad

part no.	position/branch	part no.	position/branch
70265	6	70205	10
70285	8	70225	12



6-Way ATC®/ATO® Fuse Panel

Protect up to six circuits with this heavy-duty fuse panel. The base is designed with a patented contour locking system which allows for multiple interlocking fuse panels, and incorporates a secondary storage unit to house extra fuses. The cover easily snaps into place for added protection. Both the base and cover are manufactured from a polycarbonate material for durability and strength. Screw mount terminals allow for easy wire connection. Rated up to 32V DC; 30 amps maximum per branch, 100 amp per panel.

part no.	description	max amps all combined
70365	6-position fuse panel w/cover	100



70011

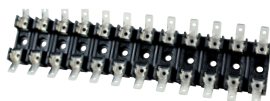

70012

Break Away Fuse Panels

These panels accept 1/4" to 1-1/4" AGC® fuses and are rated to 300V DC. Patented design does not rely on the fuse for solid, no-wobble mount. The design enables sub-dividing with simple finger pressure. Choose screw or .250" quick-connect tin-plated terminals. UL listed to IZLT2. 30 amps maximum per branch.

part no.	description	max amps per circuit
70011	screws – 12 poles	30
70012	male tabs – 12 poles	30

AGC® Fuses

These fast-acting all glass fuses solve a broad range of application requirements while offering reliable performance and cost-effective circuit protection. Temperature rating: -55°C to 125°C.

1/4" x 1 1/4"



79815



79785

part no.	amp	part no.	amp
79815	3	79855	15
79807	5	79825	20
79865	6	79808	25
79875	7.5	79835	30
79885	8	79809	35
79805	10		

part no.	description
79785	AGC® fuse, .250 tap-in bulk – min. 100 pcs.

rated to 32 volts
bulk – min. 100 pcs.



Scan for pricing or go to www.delcity.net/catalogpricing

Relays

The best solution for full voltage applications. Ideal for use with head lamps, auxiliary lamps, fog horns, fan motors, window lifters, air conditioners, heated rear windows or a myriad of other equipment existing on vehicles today. Engineered to deliver superior performance over a long life.

INFORMATION

OPERATING CHARACTERISTICS:

Permissible ambient temperature = -40°C to 125°C (-40°F to 257°F)
 Mechanical Life—no load = 10,000,000 operations (frequency 18,000 operations/hr)

The following applies for all relays unless otherwise noted:

- Operating voltage = 8–16V at 12V; 16–32V at 24V
- Contact voltage drop⁽¹⁾ = Typ. 50mV at 10A
- Insulation resistance⁽¹⁾ = 20MΩ Min. (DC 500V)
- Operate time⁽¹⁾ = 20ms Max.
- Release time⁽¹⁾ = 20ms Max.
- Resistive load N.O. = 50A at 14V DC
- Resistive load N.C. = 30A at 14V DC
- Dielectric strength N.O.⁽¹⁾ = AC 500V, 50/60Hz 1 min
- Dielectric strength N.C.⁽¹⁾ = AC 500V, 50/60Hz 1 min
- Life Expectancy Mechanical = 10,000,000 operations (frequency 18,000 operations/hr)
- Life Expectancy Electrical = 100,000 operations (frequency 1,200 operations/hr)

A change over relay switches current from one user to another. Change over relays are used for switching from one horn to the fan, from forward to backward movement of the sliding roof, from opening to closing electrically operated windows and for two-stage uses such as fans and some rear window heating systems.

Change Over Relays

Change over relays can be used in applications that require Change Over Relays, Normally Open Relays or Normally Closed Relays.



mounting bracket

part no.	description
73980	NC/NO 12 volt, 30/50 amp

IP54 Rated

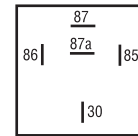
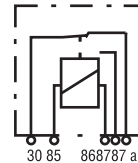

mounting bracket with resistor

part no.	description
73982	NC/NO 24 volt, 15/20 amp

Resistor reduces voltage spikes which can damage sensitive electronic equipment.
 IP54 Rated

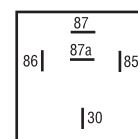

no mounting bracket

part no.	description
73984	NC/NO 12 volt, 30/50 amp

IP54 Rated

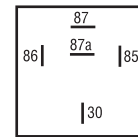
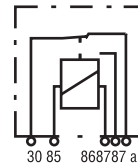

with diode

part no.	description
73986	NC/NO 12 volt, 30/50 amp

The same as 73984 with a diode. Diode eliminates voltage spikes which can damage sensitive electronic equipment.
 IP54 Rated

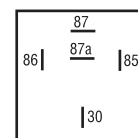
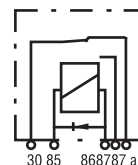

* ground diode accordingly

relays & power distribution



potted with resistor

part no.	description
73988	NC/NO 12 volt, 30/50 amp
74990*	NC/NO 12 volt, 30/50 amp

* tinned terminals & flux tight seal
Resistor reduces voltage spikes which can damage sensitive electronic equipment.
IP67 Rated

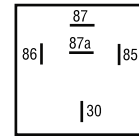
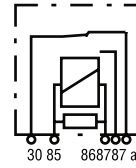

Scan for pricing or go to www.delcity.net/catalogpricing



change over relay with diode

part no.	description
73990	NC/NO 12 volt, 30/50 amp

Diode eliminates voltage spikes which can damage sensitive electronic equipment.
IP54 Rated

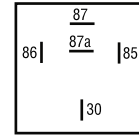
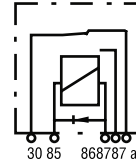

* ground diode accordingly



with resistor

part no.	description
73992	NC/NO 12 volt, 30/50 amp

Resistor reduces voltage spikes which can damage sensitive electronic equipment.
IP54 Rated

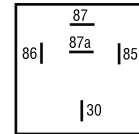
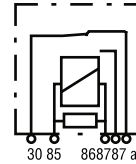

skirted with resistor and bracket

part no.	description
73994	NC/NO 12 volt, 30/50 amp

Resistor reduces voltage spikes which can damage sensitive electronic equipment.
IP54 Rated

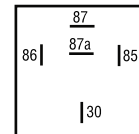

Time Delay Relay

The Time-Delay relay has a solid state timing circuit with variable resistor which allows for an adjustable time from 2 seconds to 5 minutes (must remove cover to reach adjustment screw on base). It is a normally open relay and fits standard 4 or 5 terminal harness configuration. The most common use for a time-delay relay is to power a vehicle's courtesy (dome) lights, which allows drivers and passengers additional time to exit the vehicle before the courtesy lights go dark. Voltage range: 8.2 ~ 14.8V DC. Operating temperature range: -40°C to 80°C (-40°F to 176°F).



part no.	description
74985	time delay relay

Pre-made Relay Harnesses

Molded 5-pole socket base. Manufactured with 12", 14 gauge wire leads. Wire: black-power, red-ground, white-switch, blue & green-end device.

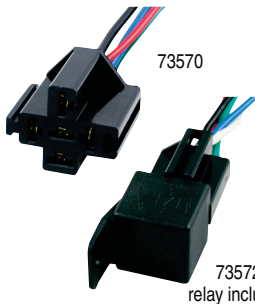

part no.	description
73570	relay socket prewired, 14 gauge, can be used with a standard 5 pin relay
73572	socket including standard relay, NC/NO 40/60 amp, 12 volts DC

* 73570 works with any standard 5 pin ISO relay

Build-Your-Own Relay Harnesses

Plug-in base for relay made of impact-resistant material. Utilizing .250" (6.3mm) flat plugs. Terminals are 16-14 gauge. Use our crimping tool 990168 (page 290).



part no.	description
73999	molded base 5-pole (terminals included)
7399920	replacement terminals for molded base (min. 100 pc. qty.)

relays & power distribution



Scan for pricing or go to www.delcity.net/catalogpricing



dual open contacts

part no.	description
73996	NO 12 volt, 30 amp (per 87 contact)

A popular relay for European cars. Double relay with two prongs will allow operation of two instruments.

IP54 Rated

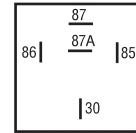
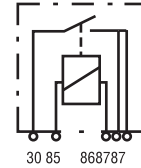

normally open w/ mounting bracket

part no.	description
73998	NO 12 volt, 70 amp

Relay includes two .250" and two .375" terminals.

IP54 Rated

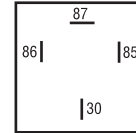
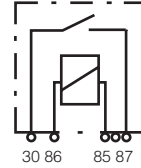

with resistor

part no.	description
74982	NC/NO 12 volt, 30/50 amp

Automotive relay with ISO micro 280 footprint. Sealed base with tinned terminals. Works with Bussman sealed fuse and relay panels.

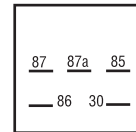
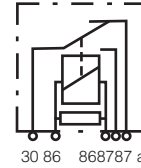

with resistor

part no.	description
74980	NC/NO 12 volt, 20/35 amp

Automotive miniature relay with ISO micro 280 footprint. Sealed base with tinned terminals. Works with Bussman sealed fuse and relay panels.

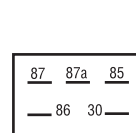

67015



67040

Solenoid Switches

They carry a current that, when energized, creates a magnetic field, which produces a high current and force. The primary advantage of a solenoid is that they require a low input while generating a larger output, as in the case of a starter solenoid. Rated for 12 or 24V DC.

INFORMATION

Solenoids are similar to a relay, but unlike regular relays, they are used for heavy-duty applications like a motor on-off control. There are five characteristics to consider when choosing a solenoid: intermittent or continuous, insulated or grounded, voltage, number of studs and material housing.

part no.	description	make/break rating	cont.	stud count
67000	S.P.S.T., intermittent 12V DC	600/200	—	3
67010	S.P.S.T., continuous 12V DC	—	100	4
67015	S.P.S.T., continuous 12V DC	—	100	3
67020	S.P.S.T., continuous 24V DC	—	100	4
67025	S.P.S.T., intermittent 12V DC	750/100	—	3
67035	S.P.D.T., continuous 12V DC	—	85	6
67040*	S.P.D.T., continuous 12V DC	—	100	4
NEW 8000370	S.P.D.T., continuous 12V DC		200	4

* weatherproof

relays & power distribution

Power Distribution Block



This power distribution block has a 3/8" post and 8, #8-21 connection screws made from corrosion resistant stainless steel. Connection plate made from nickel-plated copper for better conductivity. Base material is glass filled nylon. Mounting is 2.5" center-to-center. Rated to 48V DC 160 amps max., 20 per circuit.

part no.	description	input stud	output stud
70008	8-point power distribution block	3/8"	#8-21



Scan for pricing or go to www.delcity.net/catalogpricing

80002DL



80000DL

Power Distribution Blocks

Choose from either single or dual distribution blocks that are manufactured from high temperature plastic. The small footprints of the single and dual blocks make them ideal for tight areas. Both feature recessed mounting holes for a flush, clean look and tin plated hardware (lock washer and nut) for added durability and corrosion resistance.

screw type

part no.	description	color	stud size
80000DL	single power distribution block	red	1/4"
80001DL	single power distribution block	black	1/4"
80002DL	dual power distribution block	black	1/4"
80004DL	single power distribution block	black	5/16"
80006DL	single power distribution block	red	3/8"
80007DL	single power distribution block	black	3/8"
80008DL	dual power distribution block	black	3/8"

70000



Stud Type Junction Block

Designed for power cable connections on various vehicle electrical systems. Ideal for fire wall mounting. Feed studs are made from plated copper alloy. Nuts and washers ship in bulk. Rated up to 250 amp max.

part no.	description	stud size	color
70000	stud-type junction block	3/8"	black

70007



Stud Type Junction Block

These junction blocks are ideal for mounting directly onto any flat surface with their four .219" mounting holes spaced 1.12" x 2" on a thermoplastic housing. The zinc plated brass 1/2"-13 x 1-1/2" stud allows for several wires to meet at one junction point. Nylon-locking nut and oversized washer are included. The block is rated up to 400 amps.

part no.	description	stud size
70007	stud-type junction block	1/2"

70004

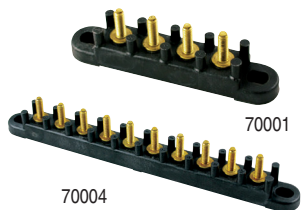

70001

Stud Type Terminal Blocks

These premium stud type terminal blocks are manufactured from black, thermoplastic material and feature brass studs. Each #10-32 stud features a "dog point" to help guide the terminal and nut onto the stud. The brass studs are 5/8", center-to-center spaced and are directly molded into the brass enabling them to withstand 25 in-lb (2.8Nm) of torque. Numbers and arrows are molded into the base to allow for positive identification. Studs are not bussed. Hardware included. Temperature rating: 248°F (120°C). Rated to 30A @ 300V UL, 30A @ 600V CSA.

part no.	no. of studs	part no.	no. of studs
70001	4	70004	10
70002	6	70005	12
70003	8	70006	14

relays & power distribution



Scan for pricing or go to www.delcity.net/catalogpricing



Stud Type Junction Box

Molded cover and housing designed to be corrosion resistant. Mounting holes are 738" center-to-center. Five open, five closed grommets and necessary hardware included. Seven independent #10-32 studs. Rated to 30A max.

part no.	description
73800	stud-type junction box



70016

Screw Type Terminal Blocks



These individual gang/non bussed terminal blocks provide a common area to neatly connect multiple wire connections. Each barrier is spaced .41" to provide protection to the #8 screw mounting areas. Each mounting area is spaced .563" center-to-center. Block accepts wire ranges from #10 - 22AWG and carries a temperature rating of -40°C to 130°C (-40°F to 260°F). Rated 30A @ 600V.

part no.	gang	part no.	gang
70013	2	70018	8
70014	4	70020	10
70016	6	70022	12



6-way Buss Bar

Distribute power from a single location. Insulated mounting bases have recessed mounting holes to prevent accidental shorts on aluminum surfaces. Two 1/4" studs, nuts and lock washers allow for input with 6 output #8 stud Phillips® screws. A black cover is also included for added protection. Rated for 100A @ 48V DC.

part no.	description	input stud	output stud
80500DL	6-way buss bar w/cover, 100A DC	1/4"	#8



80510DL

Heavy-duty Buss Bars

Designed for applications where high amps are needed. The unique modular design allows for connecting of housings to create a centralized power distribution or grounding center. Each 3/8" stud is connected to a tin plated, heavy-duty copper buss bar for maximum current flow. The covers are designed with removable side plates and a spacious interior compartment for a variety of large gauge, cable connections. Rated to 48V DC.

part no.	description	stud size
80510DL	3-way heavy-duty buss bar, 500A DC	3/8"

relays & power distribution

Power Distribution Block – Single 1 to 4 Screw Connect



The power distribution block provides a convenient location to distribute power to multiple accessory loads. It is a 1-pole connection, with two isolated inputs and four outputs. Line connection: input - (1X) 2/0-#14CU/#8AL screw connections, load connection: output (X4) #4-#14CU/#8AL screw connections. Rated up to 175A @ 600V AC.

part no.	description
79435	1-way power distribution block



Scan for pricing or go to www.delcity.net/catalogpricing

Power Distribution Block – Dual 1 to 6 Screw Connect



The power distribution block provides a convenient location to distribute power to multiple accessory loads. It is a 2-pole connection, with two isolated inputs and four outputs. Line connection: input - (1X) 2/0-#14CU/#8AL screw connections, load connection: output (X6) #4-#14CU/#8AL screw connections. Rated up to 175A @ 600V AC.

part no.	description
79445	2-way power distribution block

Power Distribution Block – Dual 1 to 6 .250" Quick-Connect



The power distribution block provides a convenient location to distribute power to multiple accessory loads. It is a 2-pole connection, with two isolated inputs and four outputs. Line connection: input - (1X) 2/0-#14CU/#8AL screw connections, load connection: output (X6) .250" quick-connect male terminal connections. Rated up to 175A @ 600V AC.

part no.	description
79425	power distribution block – .250" quick-connect

Specialty Flasher Units



When a standard flasher will not work for your application, one of these units may be exactly what you are looking for. Both are electronic-type, featuring an integrated circuit control for reliability and built-in-lamp outage indicators. The 73970 flasher alternates flashing lamps on light, fog, deck and grill lamps. The LED flasher unit is designed to work with low draw lamps and will not cause rapid flashing.

X=output; L=load; --Ground

part no.	description
73970	three pin, 12V alternating flasher unit
73975	two pin, LED flasher unit

Thermal Flashers



These two and three pin flashers fit most American cars, light trucks and vans, and meet DOT standards. Input lead must be fused at 15 amps.

part no.	description
73920	two pin, 12V (552 type)
73930	three pin, 12V (550 type)

Electro-mechanical Flashers



Meets FMSVSS108-S.A.E. J590b J945. Lasts up to 10 times longer than thermal flashers. Variable load-flashes 1 to 10 signaling lamps and 2 indicator lamps. Flash rate will not slow down when towing a trailer. Precious metal contacts. Unique audible click. Input lead must be fused at 25 amps.

part no.	description
73940	two pin, 12V
73950	three pin, 12V



Scan for pricing or go to www.delcity.net/catalogpricing

DELUXE™ Series **SW**

Stewart Warner's original gauge line sets the standard for automotive gauges with a classic and timeless look. These gauges have been around for more than 40 years and can be found in most muscle cars and street rods. Available in 25/8" & 2 1/16", sizes mechanical and electrical. Bold, easy-to-read black-on-white graphics. Polished stainless steel, low-profile bezel and white pointer with a black hub. Visit delcity.net to see the full DELUXE™ line.



4000433



4000598

gauges

HEAVY DUTY™ Series **SW**

Another of Stewart Warner's original classic gauge lines is the HEAVY DUTY™ series with an enhanced light ring for superior night time illumination. Available in 33/8" & 2 1/16", sizes mechanical and electrical. Bold, easy-to-read black-on-white graphics. Black raised bezel with distinctive brushed bright trim ring with rugged movements, ideal for use in trucks as well. Matching 5" tachometer or speedometer available. Go to delcity.net to see the full HEAVY DUTY™ line.

For complete line of gauges, go to www.delcity.net



4000515

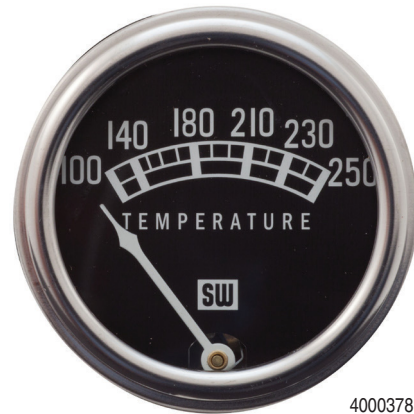

4000378

WINGS™ Series



The WINGS™ line is based on Stewart Warner's 1940's style gauges, featuring a unique pointer and a classic look for any retro application. Available in 33/8" & 2 1/16", sizes mechanical and electrical. Available in White/Black, Black/White, Black/Silver and Black/Cream graphics, each with the unique teardrop pointer. Featuring the Stewart Warner Wings logo, these gauges can be purchased individually or in kits. Go to delcity.net to see the full WINGS™ series.

STANDARD™ Series **SW**

Stewart Warner designed the Standard series gauges to be used as accessory gauges mounted under the large dashboards of cars and trucks from the 40's to the 60's, also used in any other preferred application. Available in 2 1/32" size with a flat bright stainless steel bezel. Unique pointer with hub located on the bottom. Original white-on-black graphics arranged in a 60-deg arc. All STANDARD™ gauges are non-illuminated, but illuminated versions are available by purchasing the Standard Plus kits. Visit delcity.net to see the full STANDARD™ series.

Electrical Gauges



Scan for
pricing
or go to
[www.delcity.net/
catalogpricing](http://www.delcity.net/catalogpricing)



Gauge Line - Water Temperature Gauges

The Gauge Line water temperature gauges measure and display the coolant temperature of vehicle's or machinery's engine. These gauges are available in various temperature scales and provide exceptional night-time lighting.

part no.	description	size	face
4122255	100°F-250°F, water temp	2 1/16"	single
4122272	100°F-250°F, water temp	2 1/16"	dual



Gauge Line - Oil Temperature Gauges

The Gauge Line oil temperature gauges measure and display the oil temperature of vehicle's or machinery's engine. These gauges are available in various temperature scales and provide exceptional night-time lighting.

part no.	description	size	face
4122267	140°F-320°F, oil temp	2 1/16"	single
4122279	140°F-320°F, oil temp	2 1/16"	dual



Gauge Line - Transmission Oil Temperature Gauges

The Gauge Line transmission oil temperature gauges are used to measure and display the oil temperature of a vehicle's or machinery's transmission. These gauges are available in various temperature scales and provide exceptional night-time lighting.

part no.	description	size	face
4122269	140°F-320°F, trans oil temp	2 1/16"	single
4122281	140°F-320°F, trans oil temp	2 1/16"	dual



Gauge Line - Oil Pressure Gauges

The Gauge Line oil pressure gauges are used to measure and display the oil pressure of a vehicle's or machinery's engine. These gauges are available in various pressure scales and provide exceptional night-time lighting.

part no.	description	size	face
4122256	100 PSI	2 1/16"	single
4122273	100 PSI	2 1/16"	dual
4122264	150 PSI	2 1/16"	single
4122276	150 PSI	2 1/16"	dual



Gauge Line - Fuel Level Gauges

The Gauge Line fuel level gauges are used to measure and display the fuel level of a vehicle or machinery. These gauges are available in the electrical single scale version only and matched for a 240-33.5 ohms sender. Scale is not included.

part no.	description	size	face
4122258	240-33.5 ohms	2 1/16"	-



Gauge Line - Voltmeter

The Gauge Line voltmeter gauges are instruments used to measure the alternator voltage output and battery voltage output when the engine is not running. These gauges are most commonly used in motorcycles and automotive applications. Available in the electrical single scale version only.

part no.	description	size	face
4122257	240-33.5 ohms	2 1/16"	single

Mechanical Gauges



Scan for
pricing
or go to
[www.delcity.net/
catalogpricing](http://www.delcity.net/catalogpricing)



Gauge Line - Water Temperature Gauges

The Gauge Line water temperature gauges measure and display the coolant temperature of vehicle's or machinery's engine. These gauges are available in various temperature scales and provide exceptional night-time lighting.

part no.	description	size	face
4122260	100°F-250°F, water temp	2 1/16"	single
4122270	100°F-250°F, water temp	2 1/16"	dual



Gauge Line - Oil Temperature Gauges

The Gauge Line oil temperature gauges measure and display the oil temperature of vehicle's or machinery's engine. These gauges are available in various temperature scales and provide exceptional night-time lighting.

part no.	description	size	face
4122268	140°F-320°F, oil temp	2 1/16"	single
4122280	140°F-320°F, oil temp	2 1/16"	dual



Gauge Line - Oil Pressure Gauges

The Gauge Line oil pressure gauges are used to measure and display the oil pressure of a vehicle's or machinery's engine. These gauges are available in various pressure scales and provide exceptional night-time lighting.

part no.	description	size	face
4122259	0-100 PSI	2 1/16"	single
4122271	0-100 PSI	2 1/16"	dual
4122265	0-150 PSI	2 1/16"	single
4122277	0-150 PSI	2 1/16"	dual



Gauge Line - Fuel Pressure Gauges

The Gauge Line fuel pressure gauges are used to measure and display the fuel pressure of a vehicle's or machinery's engine. These gauges are available in a mechanical version only and in 100 psi single and dual pressure scales.

part no.	description	size	face
4122266	0-100 PSI	2 1/16"	single
4122278	0-100 PSI	2 1/16"	dual



Gauge Line - Vacuum/Boost

The Gauge Line vacuum/boost gauges measure manifold vacuum or air pressure to help identify leaks and other vacuum or pressure malfunctions. These gauges are available in the mechanical single scale version only.

part no.	description	size	face
4122261	30 inHg-30 PSI	2 1/16"	single
4122278	0-100 PSI	2 1/16"	dual

Industrial Gauges



Scan for pricing
or go to
www.delcity.net/catalogpricing



Speedometer with Odometer Gauge

A Datcon-brand heavy-duty 33/8", 12 volt electric, dual dial speedometer with odometer. This gauge measures speed in both English (0–80 MPH) and Metric (0–120 KMH) and records mileage traveled. Gauge includes light with socket, mounting hardware and installation instructions.

part no.	description	size	face/bezel color
9103645	0–80 mph, speedometer w/odometer	3 ³ / ₈ "	black/black



Tachometer with Hourmeter Gauge

A Datcon-brand heavy-duty 33/8", 12 volt electric, tachometer with hourmeter. This gauge measures both engine revolutions per minute in the range of 0–4000 RPMs and records your engine operation time up to 100,000 hours. Gauge includes light with socket, mounting hardware and installation instructions.

part no.	description	size	face/bezel color
9103684	4000 RPM, tachometer w/hourmeter	3 ³ / ₈ "	black/black



Water Temperature Gauge

A Datcon-brand heavy-duty 21/16", 12 volt electric, dual dial water temperature gauge. This gauge measures and displays in both English and Metric temperatures, ranging from 100–280°F (40–140°C). Gauge includes mounting hardware and installation instructions. Sender and light with socket assembly are sold separately (see page 168).

part no.	description	size	face/bezel color
9100182	100°F–280°F, water temp	2 ¹ / ₁₆ "	black/black



Voltmeter Gauge

A Datcon-brand heavy-duty 21/16", 12 volt electric, dual dial voltmeter gauge. This gauge measures voltage both numerically from 8–18 volts and in a color system that easily indicates if proper voltage is being maintained. Gauge includes mounting hardware and installation instructions. Light with socket sold separately (see page 168).

part no.	description	size	face/bezel color
9100166	8–18V, voltmeter	2 ¹ / ₁₆ "	black/black



Oil Pressure Gauge

A Datcon-brand heavy-duty 21/16", 12 volt electric, dual dial oil pressure gauge. This gauge measures in both English (0–100 psi) and metric (1–6 bar) utilizing a 240–33.5 Ohm electrical pressure sender. Gauge includes mounting hardware and installation instructions. Sender and light with socket assembly are sold separately (see page 168).

part no.	description	size	face/bezel color
9100174	0–100 psi, oil pressure	2 ¹ / ₁₆ "	black/black



Fuel Level Gauge

A Datcon-brand heavy-duty 21/16", 12 volt electric, fuel level gauge. This gauge measures and displays fuel level within the range of empty to 1/2 full. This gauge requires a 240–33.5 Ohm fuel level sender. Gauge includes mounting hardware and installation instructions. Sender and light with socket assembly are sold separately (see page 168).

part no.	description	size	face/bezel color
9100176	E-1/2-F, fuel level, electric	2 ¹ / ₁₆ "	black/black

Hourmeters, Kits and Accessories



Scan for pricing or go to www.delcity.net/catalogpricing



9100689



9102033

Hourmeters

A Datcon-brand electronic Hourmeter records operation hours of your engine or machinery. Choose from a round, 3 hole flange, 9,999.9 count or a rectangular, 2 hole flange, 99,999.9 count. They connect directly to your electrical system via the convenient .250" push-on terminals mounted on the rear of the housing. Instructions included for a proper installation.

part no.	description	volt rating
9100689	9,999.9 count round hourmeter	12–32V DC
9102033	99,999.9 count rectangle hourmeter	10–80V DC

Heavy-duty Gauge Kits



A Datcon-brand heavy-duty, 12 volt electric, gauge kits provide you a complete cluster for heavy-duty engine monitoring needs. 9200001 is a 4 gauge kit that includes 1 each of the 2 1/16" water temperature, oil pressure, fuel level and voltmeter. 9200002 is a 6 gauge kit that includes the 3 3/8" speedometer and tachometer and 1 each of the 2 1/16" water temperature, oil pressure, fuel level and voltmeter. Both kits include all necessary senders, sensors, lights with sockets, mounting hardware and installation instructions.

For a complete listing of kit contents, see page 331-332.

part no.	description	face/bezel color
9200001	4 gauge heavy-duty kit	black/black
9200002	6 gauge heavy-duty kit	black/black

24 Volt Light Adapter Kit

The light adapter kit is a replacement bulb for the existing 12 volt bulb. This kit allows for the 12 volt electrical and mechanical gauges to be converted for 24 volt DC applications.



part no.	description
4122335	24 volt light adapter kit

24 Volt Adapter Kit

The adapter kit is a small circuit board that attaches to the input feed of the electrical gauge to reduce the voltage from 24V to 12V DC



part no.	description
4122356	24 volt adapter kit

gauges

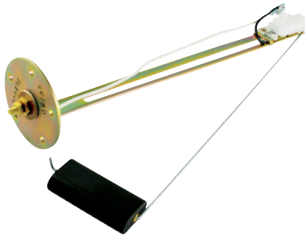

Fuel Sender

Fuel senders use a float arm to measure the level of fuel within your fuel tank and relay the information to your fuel gauge. For use with gauges measuring 240 Ohms (empty) to 33.5 Ohms (full) resistance. Adjustable float arm ranges from 6" to 24". Sender utilizes a common ground. Mounts in position 2 or 4, with a #10-32 stud electrical connection.

part no.	description
9100438	240-33.5 ohm, adjustable fuel sender



Oil Pressure Sender

Pressure senders measure oil pressure within your engine and relay the information to your oil pressure gauge. Measures 0-100 PSI / 0-7 BAR at 240-33.5 Ohm resistance. Engine connection input is 1/8"-27 thread. Electrical connection is #10-32 stud. Sender utilizes a common ground.

part no.	description
9025050	100 PSI pressure sender



Temperature Sender

Temperature senders measure your coolant temperature and relay the information to your temperature gauge. Measures 100-280°F and 140-320°F temperatures. Engine connection input is 1/2"-14 NPT thread. Electrical connection is #10-32 stud. Sender utilizes a common ground.

part no.	description
9020250	100°F-280°F temp sender

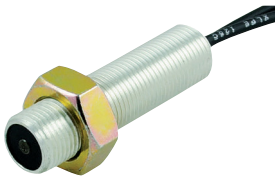

Magnetic Sensor

Magnetic sensors connect to your vehicle's transmission and are used to relay signals to your speedometer, that then can convert the information into miles per hour. Fits 5/8 -18 x 1.9" UNF mounting hole and includes 6.5" wire leads.

part no.	description
9715440	magnetic sender



Industrial Gauge Light Kit

A 12 volt light and socket (not included with Datcon-brand heavy-duty gauges) help illuminate your gauge face when used in dark settings or at night. Grounds to the gauge at the 5/8" mounting hole and includes an 11" power lead wire. Illumination is rated at 1 candlepower of light.

part no.	description
9062150	Datcon-brand, heavy-duty light kit



Scan for pricing or go to www.delcity.net/catalogpricing



Scan for pricing or go to www.delcity.net/catalogpricing

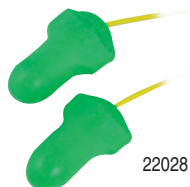

22028



22029DL

Ear Plugs

Avoid exposing your eardrums to loud machinery, tools or other excessively loud sounds that can damage your hearing. Use ear plugs that provide a 30 NRR (noise reduction rating) in both comfort small ear canal and max protection. Both available in loose and corded pairs.

part no.	description	pkg. qty.
22027	ear plug, comfort, 30 noise reduction rating	1 pr.
22028	ear plug w/cord, comfort 30 noise reduction rating	1 pr.
22029DL	ear plug, maximum 33 noise reduction rating	1 pr.

Safety Glasses

Protect your eyes in style and comfort. Each pair of glasses have their own unique features. All have anti-fog lenses. Choose from Visitor, Traditional, Sport or Wraparound styles.



Traditional glasses provide protection with side shields, fully adjustable temples and clear, anti-fog lenses.

part no.	description
22023	safety glasses, traditional



Sport glasses provide a rugged and modern look with protective side shields, rubber earpieces for secure fit and clear, anti-fog lenses.

part no.	description
22024	safety glasses, sport



Wraparound glasses provide fully adjustable temple lengths and clear, anti-fog lenses.

part no.	description
22025	safety glasses, wraparound



Visitor glasses are economical, comfortable, safety glasses that can be used alone or over eyeglasses.

part no.	description
22026	safety glasses, visitor specs



22043

Hard Hats

Hard hats provide standard bump protection for your head in various work areas. Available in both white and yellow, each feature an easy-to-adjust suspension band with washable sweatband.

part no.	description
22043	yellow hard hat, adjustable
22044DL	white hard hat, adjustable

safety products



Latex Gloves (5 MIL)

Designed as an all-purpose glove for general use in an industrial environment. Each glove is "powder-free" and has a beaded cuff for added strength, offering a comfort fit with superior dexterity.

part no.	description	size	box qty.
22010DL	latex rubber gloves	L	100
22011DL	latex rubber gloves	XL	90



Nitrile Gloves (6 MIL)

These gloves are designed to protect against chemicals and abrasives. Each glove is "powder-free," puncture-resistant and offer an allergy-free alternative to latex gloves.

part no.	description	size	box qty.
22012	nitrile rubber gloves	L	100
22013	nitrile rubber gloves	XL	90



Chemical Resistant Gloves (15 MIL)

Gloves designed to protect against heavy-duty chemicals and abrasives. They feature treads on the palms and fingers for non-slip protection and have extended cuffs. Each is flock-lined and USDA approved.

part no.	description	size	pkg. qty.
22014	nitrile hvy-dty gloves, ext cuff	L	1 pr.
22015DL	nitrile hvy-dty gloves, ext cuff	XL	1 pr.



Warehouse Gloves

Warehouse gloves are available both in string knit or with PVC dots. String knit gloves are ideal to keep hands warm while working and can be used alone or as liners. PVC dot knit gloves are made of breathable cotton/poly and provide a superior grip on surfaces. Gloves are machine washable and ambidextrous.

part no.	description	size	pkg. qty.
22016	PVC dot knit work gloves	L	1 pr.
22017	PVC dot knit work gloves	XL	1 pr.
22018	standard knit work gloves	L	1 pr.



Coated Gloves

Rubber coated gloves feature a tight flexible fit. Each glove is knit with a rubber coated palm offering superior grip on slippery materials.

part no.	description	size	pkg. qty.
22036DL	rubber coated palm, knit work gloves	L	1 pr.
22037DL	rubber coated palm, knit work gloves	XL	1 pr.



Leather Gloves

Leather gloves offer protection against minor heat and rough or sharp objects. The safety cuffs provide additional protection for your wrists against scrapes and abrasions. Double palm leather provides an extra layer of leather in the thumb, pinky and index finger.

part no.	description	size	pkg. qty.
22019	leather palm glove w/safety cuff	L	1 pr.



Mechanix® Original Gloves

Manufactured to handle the toughest work you do, these Mechanix® gloves offer improved Clarino OW-927 synthetic leather palm, index, middle and ring fingertips. They repel 25% more water and oil, preserving the life of the glove. The two-way stretch spandex top provides a better fit and the hidden interior seam stitching and lycra inset panels ensure optimum comfort and freedom of mobility.

part no.	description	size	pkg. qty.
22021DL	Mechanix® gloves original blue	L	1 pr.
22022	Mechanix® gloves original blue	XL	1 pr.



Scan for pricing or go to www.delcity.net/catalogpricing

safety products



Scan for pricing or go to www.delcity.net/catalogpricing



Safety Vests

Safety vests provide workers instant visibility in high traffic areas. Offered in both reflective and non-reflective styles, each vest has a velcro closure.

part no.	description	size
22039DL	safety vest, orange non-reflective	S/XL
22040DL	safety vest, orange non-reflective	2X/3X
22041DL	safety vest, orange reflective	S/XL
22042	safety vest, orange reflective	2X/3X

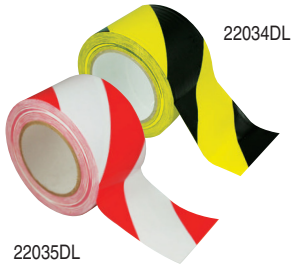

Safety Tape

Safety tape can be utilized to mark hazards in any work area. Offered in OSHA approved safety colors, the yellow/black tape signifies caution areas and the red/white tape signifies danger areas. The yellow/black tapes are 3" x 36 yard rolls and are made of 4 mm vinyl. The red/white tapes are also 3" x 36 yard rolls and are made of 8.8 mm vinyl with an over-laminate to prolong its life.

part no.	description	length
22034DL	4mil vinyl safety tape, yellow/black industrial	3" x 108'
22035DL	8.8mil vinyl safety tape, red/white heavy-duty	3" x 108'



Caution Tape

Caution tape is a non-adhesive, 3 mm yellow vinyl tape with 2" bold black "CAUTION" lettering repeated on the entire 3" x 1,000' continuous length roll. Packaged in a storage box that allows you to dispense and re-roll the tape after use, this tape can be used in many applications to mark hazardous areas.

part no.	description	length
22032DL	3mil "CAUTION" tape, non-adhesive	3" x 1,000'



Anti-Slip Tape

Anti-slip tape is a self adhesive, black sandpaper-surfaced tape pre-cut into 6" x 24" sections. Commonly used on stairs or other foot traffic areas, anti-slip tape helps prevent injuries. Each package contains 1 strip.

part no.	description	length
22045	anti-slip tape	6" x 24"



Box of Rags

These multi-purpose, red shop rags are a necessity for any shop. Ideal for cleaning oil or grease off surfaces or hands. They are reusable and launderable and have hemmed edges to prevent fraying and unraveling. Packaged in a convenient dispenser box.

part no.	description
22001DL	red shop towels, 50 count box



Scrubs-in-a-Bucket®

Scrubs-in-a-Bucket® are rough textured hand cleaner towels that are packaged in a convenient bucket type dispenser. Ideal for use on tools, hands and to clean most work surfaces.

part no.	description
22002DL	scrubs-in-a-bucket®, 72 count bucket

service supplies



12121727

Heater Hose

A replacement hose for use on most cars and light trucks, this standard grade hose withstands the abuse of corrosive solutions and additives. The black EPDM tube and cover is constructed with a two spiral polyester reinforcement that resists weathering to provide a long, trouble-free service life. Temperature resistance is -40°C to 100°C (-40°F to 212°F). **Not for steam use.**

order by the foot

part no.	description	I.D.
12126001	heater hose	5/8"
12127001	heater hose	3/4"

50' spool size

part no.	description	I.D.
12121725	heater hose	1/2"
12121726	heater hose	5/8"
12121727	heater hose	3/4"

250' spool size

part no.	description	I.D.
12126250	heater hose	5/8"
12127250	heater hose	3/4"



12124078

Fuel Line Hose

Designed for conveying gasoline, E-85, diesel and bio-diesel fuels in over the road vehicles and will withstand oil, grease, abrasion and ozone. The black Nitrile tube and Nitrile/PVC cover is constructed with a two spiral polyester reinforcement that provides a long, trouble-free service life. Fuel line hose exceeds the burst requirements of the SAE 30R6 specification and handles temperature ranges of -40°C to 100°C (-40°F to 212°F).

order by the foot

part no.	description	I.D.
12124014	fuel line hose	1/4"
12124516	fuel line hose	5/16"
12124038	fuel line hose	3/8"

25' spool size

part no.	description	I.D.
12124048	fuel line hose	3/16"
12124060	fuel line hose	1/4"
12124078	fuel line hose	5/16"
12124088	fuel line hose	3/8"
12124106	fuel line hose	7/16"

250' spool size

part no.	description	I.D.
12124068	fuel line hose	1/4"
12124084	fuel line hose	5/16"
12124100	fuel line hose	3/8"



1212225

Air Hose

Designed for service station and shop air tool applications. The red EPDM tube and cover features a four spiral polyester reinforcement that keeps the hose kink resistant and flexible in extreme temperatures. The cover is resistant to abrasion, weathering and ozone. Air hose is coupled with brass fittings and handles temperature ranges of -40°C to 100°C (-40°F to 212°F). **Not for steam use.**

25' spool box

part no.	description	I.D.
12152225	air hose, EPDM red	1/4"
12153825	air hose, EPDM red	3/8"

50' spool box

part no.	description	I.D.
12152250	air hose, EPDM red	1/4"
12153850	air hose, EPDM red	3/8"



12132998

Transmission Oil Cooler Hose

A special hose for circulating transmission fluid at high temperatures. The black Nitrile tube and Nitrile/PVC cover are designed to meet OEM and SAE J1532 requirements. The hose features a polyester reinforcement for high burst protection. Transmission oil cooler hose is resistant to fuel, ozone, oil, grease, and heat aging and fluid temperature of -34°C to 125°C (-30°F to 257°F).

25' spool box

part no.	description	I.D.
12132998	nitrile/PVC trans oil cooler hose	5/16"
12131616	nitrile/PVC trans oil cooler hose	3/8"



Scan for pricing or go to www.delcity.net/catalogpricing



Scan for pricing or go to www.delcity.net/catalogpricing



12133395

Windshield Wiper/Vacuum Hose

A low pressure tubing for windshield washers, vacuum and emissions systems for power accessories. The black EPDM tube meets SAE J1037 specification and will not deteriorate from heat, weathering or ozone. Windshield/Vacuum hose maintains its flexibility even at low temperatures ranging from -40°C to 100°C (-40°F to 257°F). **Not for steam use.**

50' spool box

part no.	description	I.D.
12133395	vacuum hose	7/16"
12133405	vacuum hose	5/32"
12133415	vacuum hose	7/32"
12133425	vacuum hose	9/32"

Hose Cutter



Cut-A-Way® hose cutter cuts all automotive hoses, flexible, watertight and schedule 40 PVC conduit up to 1" in diameter. The 8" nylon handles and stainless steel blade create a tough, lightweight tool for making fast, clean cuts.

part no.	description
GKC-100A	cut-a-way® hose/PVC cutter

Hydraulic Steel Brake Lines

An excellent choice for aftermarket fluid transfer line repair and replacement. The steel lines and tubing are constructed to provide safety and longevity. The tubing is produced by wrapping copper-coated steel around itself twice to form the tubing. This double-wall tube is what provides the strength and structural integrity to withstand the extreme pressures required, yet still remain pliable enough to be formed and bent to the shapes required to be routed beneath the vehicle without kinking. The finished tube is fused and zinc-coated to provide excellent rust and corrosion resistance. Standard steel lines are DOT approved for hydraulic brake systems and the tubing meets SAEJ527b, SAEJ1290, GM123M and DIN 74234 specifications. Available in 3/16", 1/4" & 5/16" tube sizes and various finished lengths.



12310308



12310408



12310500

3/16" I.D.

part no.	description	length
12310308	hydraulic steel brake line	8"
12310312	hydraulic steel brake line	12"
12310320	hydraulic steel brake line	20"
12310330	hydraulic steel brake line	30"
12310340	hydraulic steel brake line	40"
12310351	hydraulic steel brake line	51"
12310360	hydraulic steel brake line	60"

1/4" I.D.

part no.	description	length
12310408	hydraulic steel brake line	8"
12310412	hydraulic steel brake line	12"
12310420	hydraulic steel brake line	20"
12310430	hydraulic steel brake line	30"
12310440	hydraulic steel brake line	40"
12310451	hydraulic steel brake line	51"
12310460	hydraulic steel brake line	60"

5/16" I.D.

part no.	description	length
12310508	hydraulic steel brake line	8"
12310512	hydraulic steel brake line	12"
12310520	hydraulic steel brake line	20"
12310530	hydraulic steel brake line	30"
12310540	hydraulic steel brake line	40"
12310551	hydraulic steel brake line	51"
12310560	hydraulic steel brake line	60"

3/8" I.D.

part no.	description	length
12310608	hydraulic steel brake line	8"
12310612	hydraulic steel brake line	12"
12310620	hydraulic steel brake line	20"
12310630	hydraulic steel brake line	30"
12310640	hydraulic steel brake line	40"
12310651	hydraulic steel brake line	51"
12310660	hydraulic steel brake line	60"

25' coil size

part no.	description	I.D.
12310300	hydraulic steel brake line	3/16"
12310400	hydraulic steel brake line	1/4"
12310500	hydraulic steel brake line	5/16"

Brake Line Fitting Kits

These kits are assembled with the most common brake line fittings for both imperial and metric size lines. Kit #12312104 contains 26 pieces and kit #12312158 contains 110 pieces within a durable and lightweight plastic carrying case (10 3/4" x 6 3/4" x 1 1/4").

For a complete listing of kit contents, see pages 331-332.

part no.	description	pieces
12312104	brake line fitting, 104 pcs assort. metric/std	26
12312158	brake line fitting, 158 pc assort.	110



service supplies

NeoForm® Wiper Blades (Trico)



These blades are the elite version of the Memory Curve Steel® beam blades. An exclusive Teflon® surface protector wiping element provides a smoother wipe and longer life. The “skin coating” seals the aerodynamic spoiler to protect it from the elements. With no exposed parts, they are resistant to snow and ice clogging providing excellent performance in winter conditions. NeoForm® blades feature a pre-assembled connector to fit popular wiper arm types and specialty wiper arm coverage, such as the new Side Pin, Pinch Tab and Push Button wiper arms. They are available in lengths from 16" to 24" to cover a broad range of aftermarket applications.



Scan for
pricing
or go to
[www.delcity.net/
catalogpricing](http://www.delcity.net/catalogpricing)

part no.	description
12016160	16" NeoForm® beam style wiper blade
12016170	17" NeoForm® beam style wiper blade
12016180	18" NeoForm® beam style wiper blade
12016190	19" NeoForm® beam style wiper blade
12016200	20" NeoForm® beam style wiper blade
12016210	21" NeoForm® beam style wiper blade
12016220	22" NeoForm® beam style wiper blade
12016240	24" NeoForm® beam style wiper blade



Tech® Wiper Blades (Trico)

Universal beam blades are available at an entry level price. Each features an advanced flexible Memory Curve Steel® beam that provides uniform pressure for a clean, clear wipe. Its SWIFT® Easy connection technology offers quick and easy wiper replacement that fits both traditional and OE specialty arm types. Tech® Series blades offer an aerodynamic spoiler to ensure positive wiper contact at various driving speeds and superior all weather performance. These wiper blades are tested to perform over 1.5 million cycles.

part no.	description
12019160	16" Tech® beam style wiper blade
12019170	17" Tech® beam style wiper blade
12019180	18" Tech® beam style wiper blade
12019190	19" Tech® beam style wiper blade
12019200	20" Tech® beam style wiper blade
12019210	21" Tech® beam style wiper blade
12019220	22" Tech® beam style wiper blade
12019240	24" Tech® beam style wiper blade
12019260	26" Tech® beam style wiper blade
12019280	28" Tech® beam style wiper blade



30-Series Wiper Blades (Trico)

Extremely dependable and easy to install. Their aerodynamic steel frame provides exceptional strength and durability for a better wrap on highly curved windshields, and the precision-cut rubber edge creates superior wiping action. Each blade includes a pre-attached universal adaptor that fits 95% of vehicles on the road. Their dog leg design allows for quick and easy installation on flat wiper arm applications.

part no.	description
12030110	11" 30-Series metal frame wiper blade
12030130	13" 30-Series metal frame wiper blade
12030150	15" 30-Series metal frame wiper blade
12030160	16" 30-Series metal frame wiper blade
12030170	17" 30-Series metal frame wiper blade
12030180	18" 30-Series metal frame wiper blade
12030190	19" 30-Series metal frame wiper blade
12030200	20" 30-Series metal frame wiper blade
12030210	21" 30-Series metal frame wiper blade
12030221	22" 30-Series metal frame wiper blade
12030240	24" 30-Series metal frame wiper blade
12030260	26" 30-Series metal frame wiper blade
12030280	28" 30-Series metal frame wiper blade



Scan for pricing or go to www.delcity.net/catalogpricing

Car Covers

The PolyPro fabric is a water replant material that sheds water and breaths to reduce the buildup of mold and mildew. The soft fabric and tie downs will not scratch paint. Each car cover comes with an attached satchel for easy storage and can be used to anchor the cover to the car. Comes with a 2 year manufacturer warranty.



automobile

part no.	description	size
16144105	car cover, Polypro™1, compact	175"
16144106	car cover, Polypro™1, sedans	176" - 190"
16144104	car cover, Polypro™1, sedans	191" - 210"
16144101	car cover, Polypro™1, crossover	176" - 190"



SUV/truck

part no.	description	size
16144107	SUV/truck cover, Polypro™1, compact	187"
16144108	SUV/truck cover, Polypro™1, full size	188" - 230"
16144109	SUV/truck cover, Polypro™1, crew cab	231" - 262"

Auto Windshield Cover

Keep harmful UV rays from fading the dashboard and save time in the bitter cold scraping off ice and snow with a windshield protective cover. One size fits all standard windshields. It attaches in minutes with two click-close straps that run through the inside of the vehicle and easily folds up into a convenient storage case when not in use.



part no.	description	size
16144401	auto windshield cover, silver	67"W X 27"H

Hitch Totes

Don't let your trailer hitches and accessories bounce around loosely in your backseat or trunk where they can get lost or damage your vehicle. Store them in an easy-to-carry case. The hitch totes feature padded cases to protect both hitches and vehicles. They also have convenient storage pockets for pins and locks with rip-and-grip closure tabs. The handles make for easy carrying and the big zippers are easy to open and close.



part no.	description	size
16144201	standard black tote	up to 18" extension & 8" drop
16144202	standard Realtree™camouflage tote	up to 18" extension & 8" drop
16144203	tri-ball black tote	up to 12"L X 8"W X 5"H
16144204	tri-ball Realtree™ camouflage tote	up to 12"L X 8"W X 5"H

service supplies

Cast Blast

Cast blast paint is ideal for rebuilders and restorers as the paint finish provides a new cast iron or aluminum appearance to rebuilt parts. It is perfect for cylinder heads, blocks, alternators, calipers, water pumps and other cast iron or aluminum parts. It is heat resistant and formulated for quick drying.



part no	description	color	size
13016048	paint	flat black	16 oz.
13016055	paint	aluminum	16 oz.



Scan for pricing or go to www.delcity.net/catalogpricing

Heat Resistant Engine Paints

The Spruce line of heat resistant aerosol engine paints are a low cost alternative with a quality finish that will meet your engine rebuild needs. They quickly restore the OEM appearance of automotive, marine engines and transmissions. The Spruce line is designed to resist blistering, peeling or cracking at normal engine temperatures and is resistant to rust, heat and chemicals.



part no	description	color	size
13069841	heat resistant paint	chrome aluminum	16 oz.
13069842	heat resistant paint	universal GM black	16 oz.
13069843	heat resistant paint	Ford gray	16 oz.
13069844	heat resistant paint	Ford/Chrysler red	16 oz.
13069846	heat resistant paint	Ford blue	16 oz.
13069848	heat resistant paint	Chevy orange	16 oz.
13069856	heat resistant paint	Ford Mustang blue	16 oz.
13069867	heat resistant paint	GM Blue	16 oz.

Heat Resistant Lacquers and Primers

The standard line of heat resistant lacquers and primers is ideal for general use. It is a low cost alternative with a quality finish. These lacquers and primers can be used on wood and metal surfaces, indoors or out. They are designed to resist blistering, peeling and chemicals.



part no	description	color	size
13069838	lacquer paint	semi gloss black	16 oz.
13069831	lacquer paint	gloss clear	16 oz.
13069815	primer paint	spruce light gray	16 oz.
13069816	primer paint	spruce black	16 oz.
13069826	primer paint	spruce red oxide	16 oz.

Latex Gloves (5 MIL)

Designed as an all-purpose glove for general use in an industrial environment. Each glove is "powder-free" and has a beaded cuff for added strength, offering a comfort fit with superior dexterity.



part no.	description	size	box qty.
22010DL	latex rubber gloves	L	100
22011DL	latex rubber gloves	XL	90

Nitrile Gloves (6 MIL)

These gloves are designed to protect against chemicals and abrasives. Each glove is "powder-free," puncture-resistant and offer an allergy-free alternative to latex gloves.



part no.	description	size	box qty.
22012	nitrile rubber gloves	L	100
22013	nitrile rubber gloves	XL	90

Industrial MRO High Solids Paint

The MRO solids paint contain a higher concentrate of paint solids per can. The higher solids provides a superior single coat coverage that saves time and money with fewer cans and coats needed per application. All MRO paints are a gloss finish and retain original color under normal weather conditions. The paint withstands high humidity, splash and spray, but not recommended for continual immersion. Rated up to 121 degree C (250 degree F) dry heat.



part no	description	color	size
13201407	high solids primer	red oxide	20 oz.
13201431	high solids primer	light gray	20 oz.
13201413	high solids paint	gloss white	20 oz.
13201415	high solids paint	gloss black	20 oz.
13201417	high solids paint	dark machinery gray	20 oz.
13201418	high solids paint	light machinery gray	20 oz.
13201419	high solids paint	safety yellow	20 oz.
13201423	high solids paint	safety red	20 oz.
13201427	high solids paint	safety blue	20 oz.
13201426	high solids paint	deep blue	20 oz.
13201460	high solids paint	stainless steel	20 oz.
13201433	high solids paint	flat black	20 oz.
13201412	high solids paint	flat white	20 oz.
13201443	high solids paint	equipment yellow	20 oz.
13201446	high solids paint	ryder yellow	20 oz.
13201447	high solids paint	cummings beige	20 oz.
13201449	high solids paint	dark green	20 oz.
13201450	high solids paint	omaha orange	20 oz.
13201452	high solids paint	safety green	20 oz.
13201686	high solids paint	school bus yellow	20 oz.

Farm Equipment Enamel

Farm equipment enamel is a heavy-duty farm tractor and implement paint. The higher solids composition provides superior single coat coverage that saves time and money with fewer cans and coats needed per application. The enamel protects against fading and is resistant to heat and gas. Use with primer for maximum protection.



part no	description	color	size
13016210	farm equipment high solids enamels	Allis Chalmers orange	16 oz.
13016212	farm equipment high solids enamels	equipment old yellow	16 oz.
13016213	farm equipment high solids enamels	equipment new yellow	16 oz.
13016214	farm equipment high solids enamels	IHC red	16 oz.
13016266	farm equipment high solids enamels	farm implement yellow new	16 oz.
13016268	farm equipment high solids enamels	farm implement green new	16 oz.

High Temperature Coating (Hot Spot)

This is a specialty coating designed to create a porcelain-like bond at high temperatures. Apply the high temperature paint to headers, manifolds, exhaust pipes, mufflers, diesel stacks, furnaces or any other high heat application. The Hot Spot coating must be heat cured for two hours at a minimum of 204 degree C (400 degree F). Do not use a primer with Hot Spot. Rated up to 648 degree C(1200 degree F) continuous use.



part no	description	color	size
13161201	Hot Spot high temp paint	aluminum	16 oz.
13161203	Hot Spot high temp paint	black	16 oz.



Scan for pricing or go to www.delcity.net/catalogpricing

service supplies

Reflective Spray Paint Coating



Reflective spray paint is a water-based paint that provides a durable reflective finish. It is ideal for outdoor use and is resistant to gasoline and intermittent water submersion. For best reflective results, apply over aluminum base coat or clean metal. Can be used on ramps, steps, ladder rungs, railings, ceramic and fiberglass.

part no	description	color	size
13016511	reflective coating	clear	16 oz.
13016516	reflective coating	yellow	16 oz.
13016530	reflective coating	fire hydrant red	16 oz.
13016532	aluminum base coat	-	16 oz.



Scan for pricing or go to www.delcity.net/catalogpricing

Rubberized Sealant (Rapid Seal)



Rapid Seal is a tough and flexible rubberized sealant that forms an elastic that seals out moisture and debris. It is ideal for stopping leaks in gutters, flashings, air vents, skylights and antennas. Rapid Seal does not contain any lead, CFC chromates or chlorinated solvents. Keep a can at home, in your RV, trailer or just about anywhere.

part no	description	color	size
13020146	Rapid Seal	black	20 oz.

Graffiti/Paint Remover



Remove graffiti/paint from most surfaces with ease. This multipurpose formula can also be used for paint and varnish removal from furniture, wood and metal surfaces. It can also be used as a gasket remover.

part no	description	color	size
13020047	graffiti/paint remover	-	16 oz.

Galvanized Coating & Primer



Restore the look of weathered galvanized metal with galvanized coating and primer. The enhanced formula provides an excellent cosmetic enhancement to chain link fences, guard rails, and water pumps. The Spray-Galv weld thru primer is a cold galvanized primer that contains 86% Type I inorganic zinc in the dried paint film. Shiny Galv also prevents rust and provides excellent outdoor protection.

part no	description	color	size
13016845	Spray Galv standard	flat gray	16 oz.
13016841	Spray Galv shiny	shiny gray	16 oz.

Ceiling Tile Coating



Need to brighten dull ceiling tiles? The ceiling tile coating is a water based paint that will cover and restore ceiling tiles to their original new look. The coating is fast drying and can be sprayed upright with no warping or sagging of the tiles. For use on both textured and acoustic tiles. Can also be used to cover stains on drywall crown moldings.

part no	description	color	size
13020051	ceiling tile paint	new white	20 oz.
13020052	ceiling tile paint	old white	20 oz.



Scan for pricing



Brake Cleaner

Quickly cleans and degreases both drum and disc brakes without disassembly. It dissolves brake fluid, oil, grease and other contaminants, leaving no residue. Non-corrosive to metals.

part no.	description	size
13066200	brake cleaner	18 oz

Not for sale in CA or other states governed by the Ozone Transport Commission



13066220

Carb/Choke Cleaner

Quickly removes fuel system gum and varnish deposits. Cleans the carburetor, automatic choke and PCV valves with a simple spray. These cleaners are safe for oxygen sensors and catalytic converters, and leave no residue.

part no.	description	size
13066220	carb/choke cleaner	16.5 oz

Not for sale in CA or other states governed by the Ozone Transport Commission



13064112

13064132

Brake Fluid

For use on US and foreign vehicles where DOT 3 Fluid is specified. Exceeds the Federal specification VV-B-680 and SAE SPEC J1703. Available in 12 and 32 ounce bottles and meets the DOT-3 Federal Standard FMVSS #116.

part no.	description	size
13064112	brake fluid – DOT-3	12 oz
13064132	brake fluid – DOT-3	1 qt



13064212

13064232

Power Steering Fluid

Specially formulated to help keep power steering units operating smoothly and quietly. It meets service requirements of GM, Ford and Chrysler and contains anti-wear, anti-foaming and anti-corrosion additives.

part no.	description	size
13064212	power steering fluid	12 oz
13064232	power steering fluid	32 oz

chemicals



Marvel Mystery Oil

Marvel Mystery Oil is a gas and oil additive that helps improve the overall performance of your vehicle. It lubricates the entire fuel system. When added to your fuel, it will reduce the amount of varnish and gum build-up.

part no.	description	size
13064013	oil additive	1 qt



Starting Fluid

Starting fluid aids in starting the engine and contains a special formulation containing upper engine lubricant. Can be used in cars, trucks, tractors, motorcycles, marine and construction equipment. Suitable for both gas and diesel. Temp rating -45°C (-65°F).

part no.	description	size
13064316	starting fluid	11 oz



White Lithium Grease

This spray grease is a multi-purpose, long-lasting lithium grease for metal to metal applications. It helps reduce friction and helps eliminate rust and corrosion.

part no.	description	size
13065016	white lithium grease	13 oz



Marvel Mystery Air Tool Oil

Protect your piston and rotary type air tools from the savages of the environment. It prevents rust formation in air tools while providing lubrication for smoother starting and longer lasting tools.

part no.	description	size
13064085	air tool oil	1 qt



Rubberized Undercoating

Specially formulated to provide a long-lasting, tough, flexible and sealed protection. Applying this to undercarriage also helps reduce road noise. Installation is made simple, point and spray.

part no.	description	size
13065020	rubberized undercoating	18 oz



Spray Lubricant

WD-40® has over 2,000 possible uses and is most commonly used as a rust penetrator or lubricant. It can also be used as a cleaner to remove paint, varnish, carbon, gum and is safe for all metal surfaces.

part no.	description	size
13110054	WD-40®	8 oz
22031DL	WD-40®	12 oz



Scan for pricing



13062421 13062422



13062711 13062712

Threadlocker

Ensure that all parts stay properly connected. Blue threadlocker is an all-purpose, medium strength additive that prevents parts from loosening due to vibration, protects against corrosion, and is ideal for 1/4" and larger applications that require disassembly with hand tools. Red threadlocker is a high-strength additive that provides heavy-duty, vibration proof, permanent locking to studs and threaded fasteners ideal for 3/8" to 1" applications not requiring periodic assembly as heat or special tools needed for disassembly.

part no.	description	size
13062421	blue threadlocker, medium strength	6 ml
13062422	blue threadlocker, medium strength	50 ml
13062711	red threadlocker, high strength	6 ml
13062712	red threadlocker, high strength	50 ml

Trim Adhesive

A general purpose adhesive that is fast drying and can be used to bond most types of automotive trim. The adjustable spray pattern allows for an easy and accurate spray pattern that can be used on fabrics, foam, upholstery, carpet, vinyl tops and other non-metal surfaces.



part no.	description	size
13062080	general trim adhesive	17 oz

Not for sale in CA or other states governed by the Ozone Transport Commission

Silicone Gasket Makers

Provides stability over a wide temperature range. Blue silicone gasket maker replaces most pre-cut gaskets and increases the sealing ability of cut gaskets. It withstands temperature extremes of -62°C to 315°C (-80°F to 600°F), intermittent to 315°C (600°F) only. Red silicone gasket maker is designed for gasket applications subject to high temperatures and pressures. It resists cracking, shrinking and movement due to thermal cycling and dries tough and flexible. Red gasket maker is rated to -62°C to 343°C (-80°F to 650°F), intermittent to 343°C (650°F) only. Both are safe for use on all sensor equipment and computer controlled vehicles.



13061061



13061071

part no.	description	size
13061061	blue silicone gasket maker	3 oz
13061071	red silicone gasket maker, high temp	3 oz

Silicone Adhesive Sealants

Creates a strong, lasting, weather resistant bond. Clear and black adhesive sealants insulate, seal and bond glass, metal, plastics, rubber, vinyl and fabrics. They dry tough and flexible and can be used as a gasket maker. Clear and black sealants are rated to -62°C to 315°C (-80°F to 600°F), intermittent to 315°C (600°F) only.



13061091



13061111

part no.	description	size
13061091	clear silicone adhesive sealant	3 oz
13061111	black silicone adhesive sealant	3 oz

Anti-Seize Compound

A high temperature compound which prevents seizing, galling and corrosion and makes disassembly of components easier. Withstands temperatures from -54°C to 1093°C (-65°F to 2000°F) and meets Mil -A907E specs. Used on engine bolts, nuts, fittings, studs and pins.



part no.	description	size
13065133	anti-seize compound, high temp	8 oz

chemicals



Box of Rags

These multi-purpose, red shop rags are a necessity for any shop. Ideal for cleaning oil or grease off surfaces or hands. They are reusable, launderable and have hemmed edges to prevent fraying and unraveling. Packaged in a convenient dispenser box.

part no.	description
22001DL	red shop towels, 50 count box



Scan for pricing



Scrubs-in-a-Bucket®

Scrubs-in-a-Bucket® are rough textured hand cleaner towels that are packaged in a convenient bucket type dispenser. Ideal for use on tools, hands and to clean most work surfaces.

part no.	description
22002DL	scrubs-in-a-bucket®, 72 count bucket



Latex Gloves (5 MIL)

Designed as an all-purpose glove for general use in an industrial environment. Each glove is "powder-free" and has a beaded cuff for added strength, offering a comfort fit with superior dexterity.

part no.	description	size	box qty.
22010DL	latex rubber gloves	L	100
22011DL	latex rubber gloves	XL	90

Safety Glasses

Protect your eyes in style and comfort. Each pair of glasses have their own unique features. All have anti-fog lenses. Choose from Visitor, Traditional, Sport or Wraparound styles.



Traditional glasses provide protection with side shields, fully adjustable temples and clear, anti-fog lenses.

part no.	description
22023	safety glasses, traditional



Sport glasses provide a rugged and modern look with protective side shields, rubber earpieces for secure fit and clear, anti-fog lenses.

part no.	description
22024	safety glasses, sport



Wraparound glasses provide fully adjustable temple lengths and clear, anti-fog lenses.

part no.	description
22025	safety glasses, wraparound



Visitor glasses are economical, comfortable, safety glasses that can be used alone or over eyeglasses.

part no.	description
22026	safety glasses, visitor specs



Scan for pricing or go to www.delcity.net/catalogpricing



Curt trailer hitches offer the best quality and dependability in towing. Easily find trailer hitches for the make and model of your car, truck and RV, as well as, trailer hitch parts and accessories for hooking your towing application.



Quickly find the receiver you need at delcity.net and utilize the simple and easy hitch selector guide.

1 1/4 INCH CLASS 1



GTW Up to 2,000 lbs.
TW Up to 200 lbs.

Pin & clip included when receiver hitch is ordered with suggested ball mount

1 1/4 INCH CLASS 2



GTW 2,500 - 3,500 lbs.
TW 250 - 350 lbs.

Pin & clip included when receiver hitch is ordered with suggested ball mount

2 INCH CLASS 3



GTW 3,500 - 8,000 lbs.
TW 350 - 800 lbs.

WD Up to 12,000 lbs.
WD TW Up to 1,200 lbs.

2 INCH HEAVY DUTY (HD)



GTW 10,000 - 12,000 lbs.
TW 1,000 - 1,200 lbs.

WD 12,000 - 14,000 lbs.
WD TW 1,200 - 1,400 lbs.

2 INCH XTRA DUTY (XD)



GTW Up to 15,000 lbs.
TW Up to 1,500 lbs.

WD Up to 16,000 lbs.
WD TW Up to 1,600 lbs.

2 1/2 INCH COMMERCIAL DUTY (CD)



GTW Up to 18,000 lbs.
TW Up to 1,800 lbs.

WD Up to 18,000 lbs.
WD TW Up to 1,800 lbs.

2 INCH FRONT MOUNT



GTW 3,000 - 5,000 lbs.
TW 300 - 500 lbs.

WD Not available
SLP 9,000 lbs. straight line pull

2 INCH RECREATIONAL VEHICLE



GTW 3,500 - 5,000 lbs.
TW 350 - 500 lbs.

WD 3,500 - 6,000 lbs.
WD TW 350 - 600 lbs.









trailer hitches & accessories

Hitch Selection Guide





Use this table to select the correct class of hitch for your vehicle. Refer to not only vehicle type, but also the trailer(s) that you will be towing. See the CURT hitch application guide at delcity.net/curt for specific hitch availability.



Scan for pricing or go to www.delcity.net/catalogpricing

Trailer Types				
Weight Ratings	Class I 2,000 lbs. GTW 200 lbs. TW	Class II 3,500 lbs. GTW 350 lbs. TW	Class III 3,500 - 6,000 lbs. GTW 350 - 600 lbs. TW	Class IV & V 6,000 lbs. - 18,000 lbs. GTW 600 - 1,800 lbs. TW
 Subcompact/ Compact cars	Class I trailer hitches			
 Sedans/ Minivans	Class I trailer hitches	Class II trailer hitches	Class III trailer hitch with weight distribution hitch	
 Light trucks/SUVs	Class I trailer hitches	Class II trailer hitches	Class III trailer hitch with weight distribution hitch	
 Full size pickups/ Utility vehicles	Class I trailer hitches	Class II trailer hitches	Class III trailer hitch with weight distribution hitch	Class III trailer hitch with weight distribution hitch or Class IV-V trailer hitch

Classes	Class I: Up to 2,000 lbs. GTW
	Class II: 2,500 - 3,500 lbs. GTW
	Class III: 3,500 - 8,000 lbs. GTW
	Class IV & V: 10,000 - 12,000 lbs. GTW
	Xtra Duty & Xtra Duty Plus: 16,000 - 17,000 lbs. GTW
	Commercial Duty & Commercial Duty Plus: 18,000 - 20,000 lbs. GTW

Estimated Trailer Weight by Length										
 Pop-up camper	11'	12'	13'	14'	15'	16'				
	1,100 lbs.	1,200 lbs.	1,300 lbs.	1,400 lbs.	1,500 lbs.	1,600 lbs.				
 Small camper	14'	16'	18'	20'	22'	24'	26'	28'	30'	32'
	2,100 lbs.	2,400 lbs.	2,700 lbs.	3,000 lbs.	3,300 lbs.	3,600 lbs.	3,900 lbs.	4,200 lbs.	4,500 lbs.	4,800 lbs.
 Large camper	14'	16'	18'	20'	22'	24'	26'	28'	30'	32'
	2,800 lbs.	3,200 lbs.	3,600 lbs.	4,000 lbs.	4,400 lbs.	4,800 lbs.	5,200 lbs.	5,600 lbs.	6,000 lbs.	6,400 lbs.
 5th Wheel	Refer to owner's manual for weight specification, towing capabilities and limitations									

For more information, contact the CURT Technical Support line at 800.798.0813.



Scan for pricing or go to www.delcity.net/catalogpricing

Understanding Towing

It is very important to review an operator's manual before purchasing a towing system. The vehicle manual has helpful information about your vehicle's capabilities and limitations. Please be aware of the different laws and restrictions which exist when towing from state to state. The State Patrol is a good resource for information.

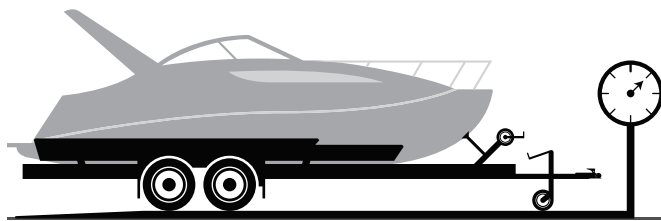
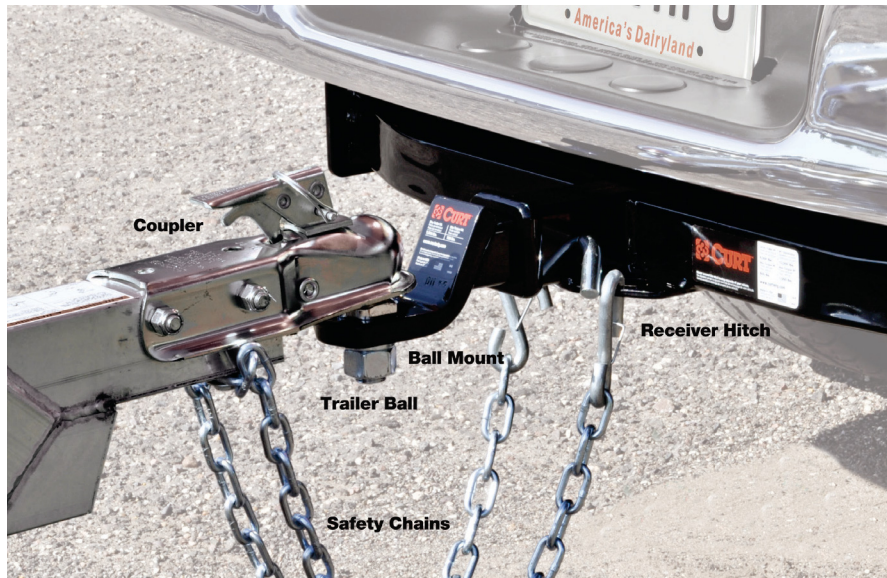

Gross Trailer Weight

(GTW) The gross trailer weight is the weight of the trailer and cargo. Measure this by putting the fully loaded trailer on a vehicle scale.

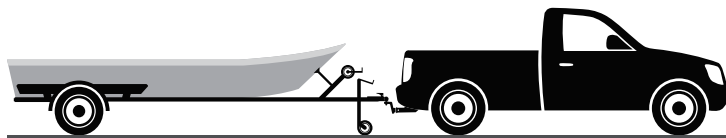

Weight Carrying

(WC) The total weight of both the trailer and the cargo inside. Never exceed the weight capacity of your trailer hitch. This applies to loads without a weight distribution hitch installed.

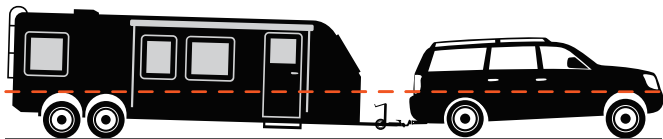

Without weight distribution

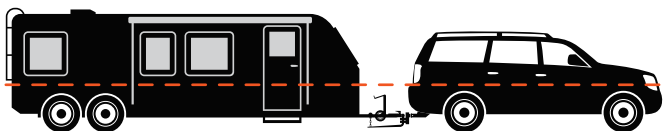

With weight distribution

Weight Distribution

(WD) Used to balance the weight of the cargo between the front and rear wheels throughout the trailer, allowing for better steering, braking and level riding. Not to be used on class I or II receiver, or with surge brakes.

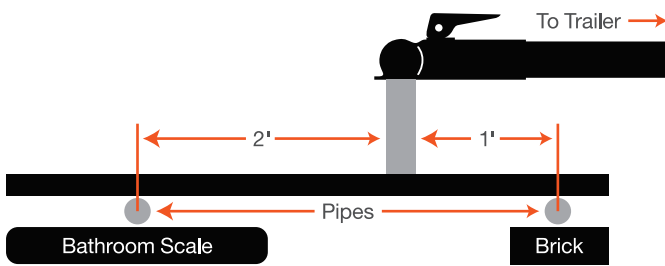

Tongue Weight

(TW) The downward force that is exerted on the hitch ball by the coupler. The tongue weight will vary depending on where the load is positioned in relationship to the trailer axle(s). To measure the tongue weight, use either a commercial scale or a bathroom scale with the coupler at towing height. When using a bathroom scale, use the method shown and multiply the scale reading by three.



Scan for pricing or go to www.delcity.net/catalogpricing

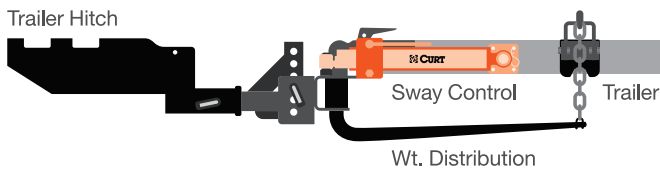

Sway Control

A device used to reduce the lateral movements of the trailer that are caused by the wind. This may be used in conjunction with a weight distribution hitch or alone. Do not use this on a class I or II hitch, or with surge brakes. See page 212.

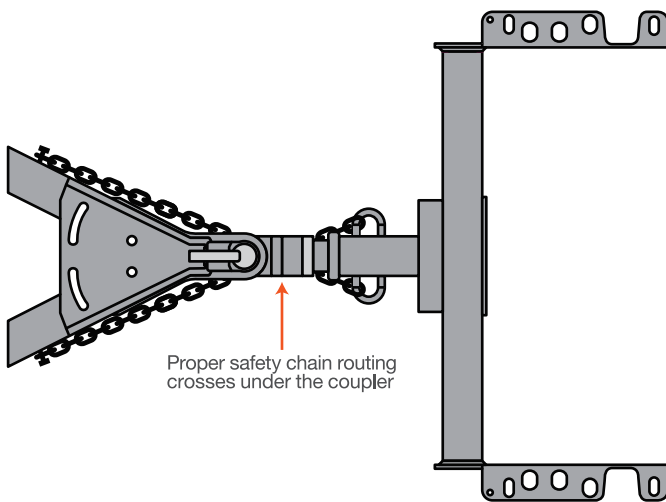

Safety Chains

Safety chains are required by law and should be crossed under the tongue of the trailer so that the tongue will not drop to the road if it becomes separated from the hitch. Always leave enough slack so you can turn. Never allow the safety chains to drag on the ground and never attach the chains to the bumper. Trailer classification: safety chain breaking force—minimum

- Class I: 2,000 lbs. (8.9 kN)
- Class II: 3,500 lbs. (16.5 kN)
- Class III: 5,000 lbs. (22.2 kN)

Each safety chain or safety cable must equal or exceed the GTW of the trailer. See page 218 for custom chain.

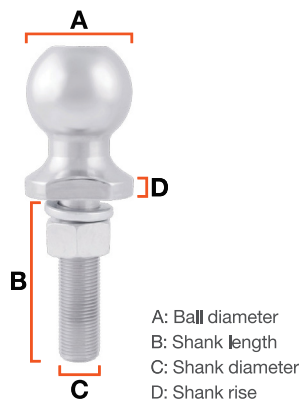

Trailer Balls

Connection from the hitch to the trailer. There are many factors that determine the correct hitch ball:

- Most important is the hitch ball's gross trailer weight rating.
- The mounting platform must be at least 3/8" thick.
- The hole diameter must not be more than 1/16" larger than the threaded shank.

Every time you tow, check the nut and lock washer to make sure they are fastened securely. See pages 198-199.

trailer hitches & accessories



Scan for pricing or go to www.delcity.net/catalogpricing



Ball Mounts

The ball mount is placed inside the opening of the receiver hitch which is mounted to the vehicle. Make sure a hitch pin and clip is properly securing the ball mount to the receiver hitch before you begin towing. See pages 184-190.



Couplers

The component that is placed over the trailer ball to connect the vehicle to the trailer. Coupler size must match the size of the hitch ball. Ensure the coupler handle is securely fastened. Trailer coupler size determines trailer ball size. Be sure your coupler is properly adjusted to the ball you are using. See page 206.



Bumper Hitches

The hitch application is used only for light weight towing, including bike racks and cargo carriers. Towing should not exceed vehicle bumper's gross towing weight. Hitch capacities are limited to bumper capacities. Do not use a weight distribution hitch with these products. See page 202.



Hitch Pins/Locks

For securing all ball mounts to receiver style hitches. Hitch locks protect against ball mount theft. See pages 193-194.



Receiver Hitches

The primary device attached to the vehicle, which allows you to tow. It is very important to choose the correct class of receiver hitch. Gross trailer weight and tongue weight will determine the hitch that is needed. Do not exceed the lowest rating of any component of your towing system. See the CURT hitch application guide at delcity.net/curt for specific hitch availability.

Class 1

Ball Mount, Pin & Clip Included
Up to 2,000 lbs. GTW
Up to 200 lbs. TW
1 1/4" Receiver Tube

Class 2

Ball Mount, Pin & Clip Included
2,500-3,500 lbs. GTW
250-350 lbs. TW
1 1/4" Receiver Tube

Class 3

(Round Tube)
3,500-8,000 lbs. GTW
350-800 lbs. TW
Up to 12,000 lbs. WD
Up to 1,200 lbs. WDTW
2" Receiver Tube

Heavy-Duty

10,000-12,000 lbs. GTW
1,000-1,200 lbs. TW
12,000-14,000 lbs. WD
1,200-1,400 lbs. WDTW
2" Receiver Tube

Xtra Duty

Up to 15,000 lbs. GTW
Up to 1,500 lbs. TW
Up to 16,000 lbs. WD
Up to 16,600 lbs. WDTW
2" Receiver Tube

Commercial Duty

Up to 18,000 lbs. GTW
Up to 1,800 lbs. TW
Up to 18,000 lbs. WD
Up to 1,800 lbs. WDTW
2 1/2" Receiver Tube

Front Mount







Up to 5,000 lbs. GTW
Up to 500 lbs. TW
9,000 lbs. Straight Line Pull
2" Receiver Tube

RV Receiver Hitches

3,500-5,000 lbs. GTW
350-500 lbs. TW
3,500-6,000 lbs. WD
350-600 lbs. WDTW
2" Receiver Tube

trailer hitches & accessories

Estimated Trailer Only Weights

 Boat trailer	Aluminum trailer 12-15 feet - Trailer weight: 200 lbs. 16-20 feet - Trailer weight: 300 lbs.	Fiberglass trailer Up to 17 feet - Trailer weight: 200 lbs. 18-20 feet - Trailer weight: 300 lbs. 21-22 feet - Trailer weight: 570 lbs. 22-24 feet - Trailer weight: 670 lbs.
 Utility trailer	Single axle 8 feet - Trailer weight: 320 lbs. 10 feet - Trailer weight: 360 lbs.	Tandem axle 12 feet - Trailer weight: 1,200 lbs. 16 feet - Trailer weight: 1,300 lbs. 20 feet - Trailer weight: 1,500 lbs.
 Recreational vehicle	Motorcycles, ATVs, Personal watercraft, Snowmobiles Carries two (8 feet) - Trailer weight: 350 lbs. Carries four (14 feet) - Trailer weight: 980 lbs.	
 Toyhauler	Toyhaulers 20 feet - Trailer weight: 4,100 lbs. 28 feet - Trailer weight: 6,600 lbs. 37 feet - Trailer weight: 12,000 lbs.	
 Livestock/Horse	Livestock trailers (gooseneck pull) 16 feet - Trailer weight: 3,500 lbs. 20 feet - Trailer weight: 4,000 lbs. 28 feet - Trailer weight: 5,000 lbs. 36 feet - Trailer weight: 7,200 lbs.	Horse trailers (bumper pull) One horse - Trailer weight: 1,800 lbs. Two horses - Trailer weight: 3,100 lbs. Four horses - Trailer weight: 4,500 lbs.
 Camper/5th Wheel	Campers 11 feet - Trailer weight: 1,200 lbs. 17 feet - Trailer weight: 2,300 lbs. 23 feet - Trailer weight: 4,200 lbs. 30 feet - Trailer weight: 4,800 lbs.	5th wheels 26 feet - Trailer weight: 5,900 lbs. 31 feet - Trailer weight: 7,800 lbs. 35 feet - Trailer weight: 10,200 lbs.



Scan for pricing or go to www.delcity.net/catalogpricing

Passenger Car & Truck Styles

Trunk hinges below window



2-door coupe



4-door sedan

Trunk hinges at roof (including window)



3-door hatchback



5-door hatchback



5-door wagon

Truck: Chassis design



Short bed/Long bed



Cab/Chassis



Dual rear wheels

Truck: Cab design



Regular cab



Extended cab



Crew cab



Quad cab

Vans, Minivans SUVs and CUVs



Van



SUV/CUV



Minivan



Extended SUV

Bumper Styles



Standard



Step



Tube



Drop

Deep Drop | Cowboy



Roll Pan (flush with tailgate)

trailer hitches & accessories

CURT™ Ball Mounts

Ball mounts are a key product in the towing industry. They are designed to be exceptionally strong and attractive. Most are CNC formed and robotically welded to ensure accurate, consistent cuts and clean, strong weld lines. Once welded, the mounts go through a secondary finishing process before a highly durable powder coat is applied.



Scan for pricing or go to www.delcity.net/catalogpricing



INFORMATION

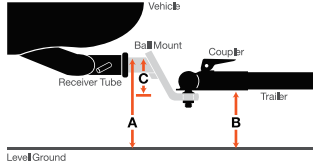

How to calculate your ball mount drop:

1. Distance from ground to top of inside diameter of receiver tube opening.
2. Distance from ground to bottom of trailer coupler.
3. Drop or rise needed.

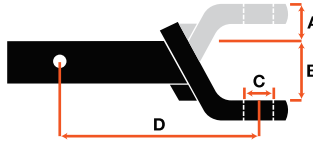

Measuring Your Ball Mount

- A. Rise
- B. Drop
- C. Hole Size
- D. Length



CURT45018

class I ball mounts

part no.	description	drop	rise	length	GTW/TW	ball hole	receiver tube
CURT45018	Ball Mount	1 1/4"	5/8"	6 3/4"	2,000/200 lbs	3/4"	1 1/4"
CURT45019	Ball Mount	1 1/4"	5/8"	9 3/4"	2,000/200 lbs	3/4"	1 1/4"
CURT45021	Ball Mount	—	3"	9 1/2"	2,000/200 lbs	3/4"	1 1/4"
CURT45023	Ball Mount	—	—	11 1/2"	2,000/200 lbs	3/4"	1 1/4"
CURT45024	Ball Mount	—	5"	9 9/16"	2,000/200 lbs	3/4"	1 1/4"
CURT45025	Ball Mount	—	5"	11 1/16"	2,000/200 lbs	3/4"	1 1/4"
CURT45022	Ball Mount	3/4"	2-5/8"	7 1/4"	2,000/200 lbs	3/4"	1 1/4"
CURT45026	Ball Mount	3/4"	2-5/8"	9 3/8"	2,000/200 lbs	3/4"	1 1/4"
CURT45027	Ball Mount	3/4"	2-5/8"	6 1/4"	2,000/200 lbs	3/4"	1 1/4"
CURT45028	Ball Mount	6"	4-5/8"	5 9/16"	2,000/200 lbs	3/4"	1 1/4"



CURT45519

class II ball mounts

part no.	description	drop	rise	length	GTW/TW	ball hole	receiver tube
CURT45518	Ball Mount	1 1/4"	3/4"	6 3/4"	3,500/350 lbs	3/4"	1 1/4"
CURT45519	Ball Mount	1 1/4"	3/4"	9 3/4"	3,500/350 lbs	3/4"	1 1/4"
CURT45014	Ball Mount	—	5"	9 5/8"	3,500/350 lbs	3/4"	1 1/4"
CURT45015	Ball Mount	—	5"	11 5/8"	3,500/350 lbs	3/4"	1 1/4"
CURT45520	Ball Mount	—	3 1/8"	9 3/4"	3,500/350 lbs	3/4"	1 1/4"
CURT45522	Ball Mount	—	3 1/8"	11 1/4"	3,500/350 lbs	3/4"	1 1/4"
CURT45016	Ball Mount	3/4"	2 5/8"	9 3/8"	3,500/350 lbs	3/4"	1 1/4"
CURT45017	Ball Mount	3/4"	2 5/8"	6 1/4"	3,500/350 lbs	3/4"	1 1/4"
CURT45501	Ball Mount	2 3/4"	2 1/8"	7 1/2"	3,500/350 lbs	3/4"	1 1/4"
CURT45521	Ball Mount	3/4"	2 5/8"	7 1/4"	3,500/350 lbs	3/4"	1 1/4"
CURT45503	Ball Mount	1"	3/8"	7 13/16"	3,500/350 lbs	3/4"	1 1/4"
CURT45510	Ball Mount	—	3 1/8"	10 5/16"	3,500/350 lbs	3/4"	1 1/4"
CURT45000	Ball Mount	—	3 7/8"	13 1/2"	3,500/350 lbs	3/4"	1 1/4"

trailer hitches & accessories

class III ball mounts



CURT45010

part no.	description	drop	rise	length	GTW/TW	ball hole	receiver tube
CURT45030	ball mount	2"	3/4"	8 1/4"	7,500/750 lbs	1"	2"
CURT45040	ball mount	2"	3/4"	10 1/4"	7,500/750 lbs	1"	2"
CURT45260	ball mount	2"	3/4"	12 1/4"	7,500/750 lbs	1"	2"
CURT45050	ball mount	4"	2"	8 1/4"	7,500/750 lbs	1"	2"
CURT45060	ball mount	4"	2"	10 1/4"	7,500/750 lbs	1"	2"
CURT45270	ball mount	4"	2"	13"	7,500/750 lbs	1"	2"
CURT45010	ball mount	2"	3/4"	8 1/4"	7,500/750 lbs	1"	2"
CURT45020	ball mount	2"	3/4"	10 1/4"	7,500/750 lbs	1"	2"
CURT45250	ball mount	2"	3/4"	12 1/4"	7,500/750 lbs	1"	2"
CURT45070	ball mount	6"	4"	9 1/4"	7,500/750 lbs	1"	2"
CURT45080	ball mount	6"	4"	12 1/4"	7,500/750 lbs	1"	2"
CURT45280	ball mount	6"	4"	14 1/4"	7,500/750 lbs	1"	2"
CURT45090	ball mount	8"	6"	11 1/2"	7,500/750 lbs	1"	2"
CURT45100	ball mount	8"	6"	13"	7,500/750 lbs	1"	2"
CURT45110	ball mount	10"	8"	13"	7,500/750 lbs	1"	2"
CURT45112	ball mount	10"	8"	14"	7,500/750 lbs	1"	2"



Scan for pricing or go to www.delcity.net/catalogpricing



CURT45290

class III chrome ball mounts

part no.	description	drop	rise	length	GTW/TW	ball hole	receiver tube
CURT45290	ball mount, chrome	2"	3/4"	8 1/4"	7,500/750 lbs	1"	2"
CURT45296	ball mount, chrome	4"	2"	8 1/4"	7,500/750 lbs	1"	2"
CURT45297	ball mount, chrome	6"	4"	9 1/4"	7,500/750 lbs	1"	2"

CURT™ Euro Ball Mounts

These ball mounts feature a modern European design. They are designed to be exceptionally strong and attractive. Most are CNC formed and robotically welded to ensure accurate, consistent cuts and clean, strong weld lines. Once welded, the mounts go through a secondary finishing process before a highly durable powder coat is applied. European ball mounts come complete with permanently attached ball.



CURT45581



CURT45591

european ball mounts

part no.	description	drop	rise	length	GTW/TW	ball hole	receiver tube
CURT45551	ball mount, euro mount	—	3/4"	6 3/4"	3,500/350 lbs	1 7/8"	1 1/4"
CURT45552	ball mount, euro mount	—	3/4"	6 3/4"	3,500/350 lbs	2"	1 1/4"
CURT45561	ball mount, euro mount	—	3 1/8"	9 3/4"	3,500/350 lbs	1 7/8"	1 1/4"
CURT45562	ball mount, euro mount	—	3 1/8"	9 3/4"	3,500/350 lbs	2"	1 1/4"
CURT45571	ball mount, euro mount	—	2 5/8"	7 1/4"	3,500/350 lbs	1 7/8"	1 1/4"
CURT45572	ball mount, euro mount	—	2 5/8"	7 1/4"	3,500/350 lbs	2"	1 1/4"
CURT45581	ball mount, euro mount	3 1/4"	-	7 1/4"	3,500/350 lbs	1 7/8"	1 1/4"
CURT45582	ball mount, euro mount	3 1/4"	-	7 1/4"	3,500/350 lbs	2"	1 1/4"
CURT45591	ball mount, euro mount	—	3 1/8"	11 1/4"	3,500/350 lbs	1 7/8"	1 1/4"
CURT45592	ball mount, euro mount	—	3 1/8"	11 1/4"	3,500/350 lbs	2"	1 1/4"



Scan for pricing or go to www.delcity.net/catalogpricing



CURT45042



CURT45331



CURT45131



CURT45047



CURT45220

CURT™ Loaded Ball Mounts

These ball mounts feature a modern European design. They are designed to be exceptionally strong and attractive. Most are CNC formed and robotically welded to ensure accurate, consistent cuts and clean, strong weld lines. Once welded, the mounts go through a secondary finishing process before a highly durable powder coat is applied. They include pin, clip and are assembled with a factory-torqued Curt trailer ball.

loaded ball mounts

part no.	description	drop	length	GTW/TW	ball dia.	finish	receiver tube
CURT45034	ball mount, bulk pack	2"	8¼"	3,500/350 lbs	1⅞"	gloss	2"
CURT45036	ball mount, bulk pack	2"	8¼"	7,500/750 lbs	2"	gloss	2"
CURT45041	ball mount, bulk pack	2"	8¼"	7,500/750 lbs	2⅝"	gloss	2"
CURT45042	ball mount, bulk pack	4"	8¼"	7,500/750 lbs	2⅝"	gloss	2"
CURT45055	ball mount, bulk pack	4"	8¼"	3,500/350 lbs	1⅞"	gloss	2"
CURT45056	ball mount, bulk pack	4"	8¼"	7,500/750 lbs	2"	gloss	2"
CURT45293	ball mount, white box	2"	8¼"	3,500/350 lbs	1⅞"	chrome	2"
CURT45295	ball mount, white box	2"	8¼"	7,500/750 lbs	2"	chrome	2"
CURT45331	ball mount, x-duty bulk pk	2"	8¼"	15,000/1,500 lbs	2"	carbide	2"
CURT45332	ball mount, x-duty bulk pk	4"	8¼"	15,000/1,500 lbs	2"	carbide	2"

fusion ball mounts

part no.	description	drop	rise	length	GTW/TW	ball hole	receiver tube
CURT45131	ball mount, fusion	2"	-	7½"	5,000/500 lbs	1⅞"	2"
CURT45134	ball mount, fusion	2"	-	7½"	7,500/750 lbs	2"	2"
CURT45151	ball mount, fusion	4"	-	8⅞"	5,000/500 lbs	1⅞"	2"
CURT45154	ball mount, fusion	4"	-	8⅞"	7,500/750 lbs	2"	2"
CURT45152	ball mount, fusion	—	2"	8⅞"	5,000/500 lbs	1⅞"	2"
CURT45155	ball mount, fusion	—	2"	8⅞"	7,500/750 lbs	2"	2"

right-angle ball mounts

part no.	description	drop	rise	length	GTW/TW	ball hole	receiver tube
CURT45047	ball mount, right-angle	2"	¾"	10¼"	7,500/750 lbs	1⅞"	2"
CURT45067	ball mount, right-angle	4"	2"	10¼"	7,500/750 lbs	2"	2"
CURT45087	ball mount, right-angle	6"	4"	12¼"	7,500/750 lbs drop 6,000/600 lbs rise	2"	2"

dual length ball mounts

part no.	description	drop	rise	length	GTW/TW	ball hole	receiver tube
CURT45220	ball mount, 2 pin hole	3/4"	3/4"	7½" & 10½"	7,500/750 lbs	1"	2"
CURT45230	ball mount, 2 pin hole	2"	2"	8⅞" & 11⅞"	7,500/750 lbs	1"	2"
CURT45240	ball mount, 2 pin hole	4"	4"	9¼" & 12¼"	7,500/750 lbs drop 6,000/600 lbs rise	1"	2"

trailer hitches & accessories

heavy-duty ball mounts



CURT45338

part no.	description	drop	rise	length	GTW/TW	ball hole	receiver tube
CURT45336	ball mount, heavy-duty	6"	4¾"	9¾"	10,000/1,000 lbs	1¼"	2"
CURT45338	ball mount, heavy-duty	8"	6¾"	9¾"	10,000/1,000 lbs	1¼"	2"
CURT45446	ball mount, heavy-duty	6"	5"	9¾"	12,000/1,200 lbs	1¼"	2"
CURT45448	ball mount, heavy-duty	8"	7"	9¾"	12,000/1,200 lbs	1¼"	2"



Scan for pricing or go to www.delcity.net/catalogpricing

forged xtra-duty ball mounts



CURT45329

part no.	description	drop	rise	length	GTW/TW	ball hole	receiver tube
CURT45425	ball mount, xtra-duty	3"	1½"	9½"	15,000/1,500 lbs	1¼"	2½"
CURT45426	ball mount, xtra-duty	5"	3½"	10"	15,000/1,500 lbs	1¼"	2½"
CURT45427	ball mount, xtra-duty	8"	6¼"	10½"	15,000/1,500 lbs	1¼"	2½"

adjustable tri-ball mounts



CURT45799

part no.	description	drop	rise	length	GTW/TW	ball hole	receiver tube
CURT45799	tri-ball, packaged, heavy-duty	5¾"	5¾"	16"	6,000/7,500/10,000 lbs	1⅞", 2", 2⅝"	2"
CURT45800	replacement head for CURT45799	—	—	—	6,000/7,500/10,000 lbs	—	—
CURT45801	adjustable shank for CURT45799	5¾"	5¾"	16"	6,000/7,500/10,000 lbs	1⅞", 2", 2⅝"	—

adjustable channel-style mount (anti-rattle)



CURT45911

part no.	description	drop	rise	length	GTW/TW	ball hole	ball dia.	receiver tube
CURT45900	heavy duty, adj	6"	5¼"	11", 12"	14,000	—	2", 2⅝"	2"
CURT45901	adjustable	6¾"	5¼"	11", 12"	6,000	1"	—	2"
CURT23556	lock set for adjustable channel-style mounts	—	—	—	—	—	—	—
CURT45910	replacement shank for CURT45900	—	—	—	—	—	—	—
CURT45911	replacement shank for CURT45901	—	—	—	—	—	—	—

adjustable ball mounts



CURT45812

part no.	description	drop	rise	length	GTW/TW	ball hole	receiver tube
CURT45812	vertically adj	7¼"	6¼"	12½"	5,000/500 lbs	1"	2"

trailer hitches & accessories

heavy-duty multi-ball ball mounts

part no.	description	length	1 ⁷ / ₈ " ball GTW/TW	2" ball GTW/TW	2 ⁵ / ₁₆ " ball GTW/TW	receiver tube
CURT45650	3 ball, solid shank, blk	7", 8 ¹ / ₂ "	5,000/500 lbs	7,500/750 lbs	10,000/1,000 lbs	2"
CURT45655	3 ball, solid shank, chrome	7", 8 ¹ / ₂ "	5,000/500 lbs	7,500/750 lbs	10,000/1,000 lbs	2"
CURT45660	2 ball, solid shank, black	8 ¹ / ₂ "	—	7,500/750 lbs	10,000/1,000 lbs	2"
CURT45665	2 ball, solid shank, chrome	8 ¹ / ₂ "	—	7,500/750 lbs	10,000/1,000 lbs	2"
CURT45001	3 ball, hollow shank, black	7", 8 ¹ / ₂ "	5,000/500 lbs	7,500/750 lbs	10,000/1,000 lbs	2"
CURT45002	2 ball, hollow shank, chrome	7", 8 ¹ / ₂ "	—	7,500/750 lbs	10,000/1,000 lbs	2"



Scan for pricing or go to www.delcity.net/catalogpricing



CURT45001



CURT45002

reversible multi-ball ball mounts

part no.	description	drop	rise	length	1 ⁷ / ₈ " ball GTW/TW	2" ball GTW/TW	2 ⁵ / ₁₆ " ball GTW/TW	receiver tube
CURT45643	2 ball, hollow shank	4"	2"	10 ¹ / ₂ "	6,000/600 lbs	7,500/750 lbs	—	2"
CURT45644	2 ball, hollow shank	4"	2"	10 ¹ / ₂ "	—	7,500/750 lbs	7,500/750 lbs	2"



CURT45643

dual-ball and clevis bar

part no.	description	GTW/TW	ball dia.	receiver tube
CURT45008	2 ball, removable clevis,	6,000/600 lbs	2", 2 ⁵ / ₁₆ "	2"



CURT45008

sway tab ball mount

part no.	description	drop	rise	length	GTW/TW	ball hole	receiver tube
CURT45820	sway control mounting	2"	3/4"	7 ¹ / ₂ "	7,500/750 lbs	1"	2"



CURT45820

multi-use ball mount

part no.	description	drop	length	GTW/TW	ball hole	receiver tube
CURT45810	stacked aux receiver	2"	12 ¹ / ₄ "	7,500/750 lbs	1"	2"



CURT45810

* Top receiver not for towing use.

dual receiver extender

part no.	description	drop	rise	length	1 ⁷ / ₈ " ball GTW/TW	receiver tube
CURT45792	dual receiver	4"	2"	8"	3,500/350 lbs	2"



CURT45792

* Top receiver not for towing use.

trailer hitches & accessories



CURT45794

raised receiver adapter

part no.	description	rise	length	GTW/TW	receiver tube
CURT45794	raised adapter	4¼"	5¼"	3,500/350 lbs	2"



Scan for pricing or go to www.delcity.net/catalogpricing



CURT45405

adapter sleeve

part no.	description	length
CURT45405	commercial-duty, adapts 2"-1" receiver to 2" x 2" receiver	5½"

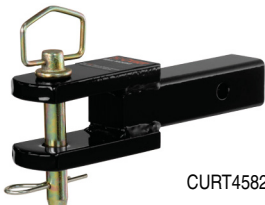

CURT45821

clevis-pin mount

part no.	description	length	GTW/TW
CURT45821	clevis-pin, 2" x 2" receiver tube	8¾"	6,000/600 lbs

* Clevis pin and clip included.

receiver tube extenders



CURT45789

part no.	description	shank size	length	GTW/TW
CURT45789*	extender, 2" x 2" receiver tube	1¼"	7"	—/350 lbs
CURT45791	extender, 2" x 2" receiver tube	2"	8"	3,500/350 lbs
CURT45795	extender, 2" x 2" receiver tube	2"	14"	3,500/350 lbs
CURT45796	extender, 2" x 2" receiver tube	2"	15"	3,500/350 lbs

* CURT45789 not for towing use.

receiver tube adapters



CURT45785

part no.	description	length	GTW/TW
CURT45785	adapts 1-1/4" to 2"	6¼"	—/350 lbs
CURT45790	adapts 1-1/4" to 2"	10"	—/350 lbs
CURT45770	adapts 2" to 1-1/4"	4"	3,500/350 lbs
CURT45775	adapts 2" to 1-1/4"	9½"	3,500/350 lbs
CURT45780	adapts 2" to 1-1/4"	15"	3,500/350 lbs
CURT45013	vertical 2" to standard 2"	4¼"	8,000/800 lbs
CURT45048	adapts 2-1/2" to 2", can be cut 24" to 34"	24" - 34"	6,000/600 lbs

* Clevis pin and clip included.

receiver tube adapters



CURT45507

part no.	description	GTW/TW	ball hole
CURT45507	vertical ball mount, 1¼" shank	3,500/350 lbs	¾"
CURT45003	vertical ball mount, 2" shank	4,000/400 lbs	1"

trailer hitches & accessories



Scan for pricing or go to www.delcity.net/catalogpricing



CURT45534

towing starter kit

part no.	description	drop	rise	length	1 ⁷ / ₈ " ball	GTW/TW	ball hole
CURT45534	kit includes: ball mount, trailer ball, hitch lock, rubber hitch cover	2"	3/4"	8 1/4"	7,500/750 lbs		2"
CURT45554	kit includes: ball mount, trailer ball, hitch lock, rubber hitch cover	4"	2"	8 1/4"	7,500/750 lbs		2"



CURT45825

tow hook mount

part no.	description	length	GTW/TW
CURT45825	2" x 2" reciver tube	7 1/2"	limited to hitch capacity
CURT45500	2" x 2" reciver tube	10"	limited to hitch capacity

CURT45824



tow-strap mount

part no.	description	length	GTW/TW
CURT45824	shackle, solid shank, for 2" x 2" receiver tube	7 1/2"	limited to hitch capacity



CURT45005

atv ball mount

part no.	description	rise	length	hole size	ball dia.
CURT45005	3-in-1, black, 2" x 2" reciver tube	1/4"	6"	5/8"	1 7/8"
CURT45009	3-in-1, black, 2" x 2"	1/4"	6"	5/8"	2"



CURT45006

bolt-on atv adapter

part no.	description
CURT45006	convert atv tongue to 2"x-2" receiver tube

trailer hitches & accessories

CURT™ Trailer Balls

The trailer balls are engineered to the highest quality for consistency, accuracy, fit and strength. The mounting stems are manufactured with fine threads to ensure maximum holding strength. All meet US V-5 specifications.



Scan for pricing or go to www.delcity.net/catalogpricing

INFORMATION



Measuring Your Ball Mount

- A. Ball Diameter
- B. Shank Length
- C. Shank Diameter
- D. Shank Rise

Shank Diam.

- 3/4"
- 1"
- 1-1/4"
- 2"

Torque Specs

- 160 ft. lbs.
- 250 ft. lbs.
- 450 ft. lbs.
- 4550 ft. lbs

trailer balls

A. ball dia.	description	B. shank length	C. shank dia.	D. shank rise	ball capacity lbs.	chrome package	chrome bulk	stainless package	stainless bulk	raw bulk
1 7/8"	standard-duty	1 5/8"	3/4"	0"	2,000	CURT40001	CURT40061	—	—	—
	standard-duty	2 1/8"	3/4"	0"	2,000	CURT40015	CURT40063	CURT40050	CURT40080	—
	standard-duty	3"	3/4"	0"	2,000	CURT40016	CURT40071	—	—	—
	standard-duty	2 1/8"	1"	0"	3,500	CURT40002	CURT40062	CURT40051	CURT40081	—
	standard-duty	3"	1"	0"	3,500	CURT40017	CURT40072	—	—	—
	standard-duty	2 3/16"	1"	1"	3,500	CURT40031	—	—	—	—
	standard-duty	2 1/8"	1"	2"	3,500	CURT40032	—	—	—	—
2"	standard-duty	1 3/4"	3/4"	0"	3,500	CURT40003	CURT40064	—	—	—
	standard-duty	2 1/8"	3/4"	0"	3,500	CURT40018	CURT40065	CURT40052	CURT40082	—
	standard-duty	3"	3/4"	0"	3,500	CURT40019	CURT40073	—	—	—
	standard-duty	2 1/8"	1"	0"	6,000	CURT40004	CURT40066	CURT40053	CURT40083	—
	heavy-duty	2 1/4"	1"	0"	12,000	CURT40038*	—	—	—	—
	standard-duty	2 1/8"	1"	1"	6,000	CURT40033	—	—	—	—
	standard-duty	2 1/8"	1"	2"	6,000	CURT40034	—	—	—	—
	standard-duty	3"	1"	0"	6,000	CURT40020	CURT40074	—	—	—
	standard-duty	2 1/8"	1"	0"	7,500	CURT40037	—	—	—	—
	heavy-duty	2 5/8"	1 1/4"	0"	10,000	CURT40090	CURT40069	—	—	—
2 15/16"	standard-duty	2 1/8"	1"	0"	7,500	CURT40005	CURT40067	CURT40054	CURT40084	—
	heavy-duty	2 1/4"	1"	0"	10,000	CURT40007	—	—	—	—
	heavy-duty	2 1/4"	1"	0"	12,000	CURT40039*	—	—	—	CURT40042
	standard-duty	3"	1"	0"	6,000	CURT40021	CURT40075	—	—	—
	heavy-duty	2 5/8"	1 1/4"	0"	10,000	CURT40006	CURT40068	—	—	—
	xtra-duty	2 5/8"	1 1/4"	0"	15,000	CURT40030	—	—	—	—
	commercial-duty	2 5/8"	1 1/4"	0"	30,000	—	—	—	—	—
	commercial-duty	2 5/8"	1 1/4"	1"	25,000	—	—	—	—	—
	heavy-duty	2 5/8"	1 1/4"	1"	10,000	CURT40035	—	—	—	—
	heavy-duty	2 5/8"	1 1/4"	2"	10,000	CURT40036	—	—	—	—
	commercial-duty	2 5/8"	1 1/4"	2"	25,000	—	—	—	—	—
	standard-duty	3"	1 1/4"	0"	6,000	CURT40022	CURT40076	—	—	—
	commercial-duty	3 1/2"	2"	0"	30,000	—	—	—	—	—
3"	commercial-duty	3 1/2"	2"	0"	30,000	—	—	—	—	—

nut & washer replacement



CURT40103

part no.	description
CURT40103	nickel finish, 3/4" nut & lock washer
CURT40104	nickel finish, 1" nut and lock washer
CURT40105	nickel finish, 1 1/4" nut and lock washer

trailer hitches & accessories

CURT™ Switch Ball™

Designed for safety and performance, the Switch Ball™ is constructed from premium grade steel and with nickel-chrome plating. The exclusive "J" groove design ensures that when the ball is installed on the shank and engaged by the coupler, the hitching system is secure. With the weight bearing capacity resting on the shank, it takes the stress away from the ball and frees the coupler from friction and binding. Complies with National Standard SAE J684 and V-5 regulations for conversion ball sets.



Scan for pricing or go to www.delcity.net/catalogpricing

switch balls



CURT42225

part no.	description	shank length	shank dia.	capacity lbs	ball dia.
CURT42178	chrome switch ball™	2¼"	1"	6,000	1⅞", 2"
CURT42225	chrome switch ball™	2¼"	1"	8,000	1⅞", 2", 2 ¹⁵ / ₁₆ "
CURT42280	chrome switch ball™	2¼"	1"	8,000	2", 2 ¹⁵ / ₁₆ "
CURT41782	chrome switch ball™	1 ⁵ / ₈ "	¾"	3,500	1⅞", 2"
CURT41783	chrome switch ball™	2¼"	¾"	3,500	1⅞", 2"

Switch Ball™ replacement balls



CURT41780

CURT42203

part no.	description	capacity lbs	ball dia.
CURT41780	bulk replacement ball	6,000	1⅞"
CURT42780	bulk replacement ball	8,000	1⅞"
CURT41200	bulk replacement ball	8,000	2"
CURT42200	bulk replacement ball	8,000	2"
CURT42203	bulk replacement ball	8,000	2 ⁵ / ₁₆ "
CURT41781	packaged replacement ball	6,000	1⅞"
CURT42781	packaged replacement ball	8,000	1⅞"
CURT41201	packaged replacement ball	8,000	2"
CURT42201	packaged replacement ball	8,000	2"
CURT42204	packaged replacement ball	8,000	2 ⁵ / ₁₆ "

Switch Ball™ replacement shanks



CURT41340

part no.	description	shank length	capacity lbs	ball dia.
CURT41340	bulk replacement shank	1 ⁵ / ₈ "	¾"	3,500
CURT41341	bulk replacement shank	2¼"	¾"	3,500
CURT42100	bulk replacement shank	2¼"	1"	6,000
CURT42103	bulk replacement shank	2¼"	1"	8,000

pintle replacement balls



CURT48810

part no.	description	shank length	capacity lbs	ball dia.
CURT48810	chrome finish replacment ball	1¼"	6,000	1⅞"
CURT48820	heavy-duty, chrome finish replacement ball	1¼"	10,000	2"
CURT48830	heavy-duty, chrome finish replacement ball	1¼"	12,000	2 ⁵ / ₁₆ "

sway control replacement balls



CURT40093

part no.	description	shank length	capacity lbs	ball dia.
CURT40093	hitch mounted replacement ball	1¾"	1¾"	1¼"

* For use with CURT17200

trailer hitches & accessories

CURT™ Trailer Security

Del City offers the complete line of CURT™ towing security products. Choose from locks for couplers and trailers, to fifth wheel and king pin locks.



Scan for pricing or go to www.delcity.net/catalogpricing

CURT21401



CURT21579



CURT21410



receiver pins and clips

part no.	description	finish
CURT21401	1/2" hitch pin w/clip	zinc
CURT21501	5/8" hitch pin w/clip	zinc
CURT21502	universal pin & clip for 1 1/4" & 2" tubes	zinc
CURT21601	clip	zinc
CURT21541	1/2" swivel pin lock	chrome
CURT21551	5/8" swivel pin lock	chrome
CURT21579	5/8" hitch pin w/clip	black zinc
CURT21581	5/8" hitch pin for 2 1/2" receivers	zinc
CURT23581	1/2" hitch pin	stainless
CURT23582	5/8" hitch pin	stainless
CURT21411	1/2" vinyl coated hitch pin w/clip	zinc
CURT21511	5/8" vinyl coated hitch pin w/clip	zinc

hitch locks

CURT23020



CURT23590



CURT23555



part no.	description	finish
CURT23020	1/2" diameter dead bolt	chrome
CURT23021	5/8" diameter dead bolt for 2 1/2" receivers	chrome
CURT23024	1/2" dia. dead bolt w/sleeve adapting from 1/2" to 5/8" dia.	chrome
CURT23572	1/2" dia. hitch lock	chrome
CURT23575	5/8" dia. hitch lock	black
CURT23579	5/8" dia. hitch lock	chrome
CURT23580	1/2" dia. dead bolt w/sleeve adapting from 1/2" to 5/8" dia.	stainless
CURT23583	5/8" dia. hitch lock	stainless
CURT23585	5/8" dia. hitch lock for 2 1/2" receivers	stainless
CURT23590	5/8" dia. hitch lock w/anti-rattle (M16-2.0 threads)	stainless

keyed alike lock sets

part no.	description	finish
CURT23555	hitch lock & coupler lock set	chrome
CURT23574	hitch lock & coupler lock set	chrome

* Sets are keyed alike and come w/4 keys

coupler locks



CURT23545

part no.	description	finish
CURT23022	narrow coupler lock	brass
CURT23541	dumbbell coupler lock, 7/8" span	chrome
CURT23542	dumbbell coupler lock, 2 1/2" span	chrome
CURT23544	dumbbell coupler lock, 3 3/8" span	chrome
CURT23545	multi-use narrow coupler lock	zinc
CURT23546	solid brass narrow coupler lock	brass
CURT23547	adjustable coupler lock	chrome

* 2 keys included.

trailer hitches & accessories



Scan for pricing or go to www.delcity.net/catalogpricing



CURT23079

trailer locks

part no.	description	finish
CURT23079	aluminum lock for rolled-lip couplers	gray powder coat
CURT23659	universal, die cast trailer lock w/dual ratchet locking systems	hammer tone epoxy
CURT23179	universal, solid hardened steel trailer lock w/dual ratchet locking system	ballistic grade nylon

* 2 keys included



CURT25080

safety pins

part no.	description	finish
CURT25080	1/4" safety pin, bulk	zinc
CURT25278	3/8" safety pin, bulk	zinc
CURT25010	5/16" safety pin, bulk	zinc
CURT25012	1/4" safety pin, bulk	zinc
CURT25081	1/4" safety pin, packaged	zinc
CURT28279	3/8" safety pin, packaged	zinc
CURT25011	5/16" safety pin, packaged	zinc
CURT25013	1/4" safety pin, packaged	zinc

CURT23175



wheel chock lock

part no.	description
CURT23175	expandable tire/wheel lock

* 3 keys included

CURT23255



king pin lock

part no.	description
CURT23255	universal aluminum king pin 5th wheel lock

* 3 keys included

CURT23556



channel-style adjustable mount lock

part no.	description
CURT23556	adjustable mount lock

* 4 keys included

CURT23666



security cable

part no.	description
CURT23666	6' 10 mm cable lock with locking & cinching feature

* 2 keys included

CURT23562



spare tire lock

part no.	description
CURT23562	universal side mount spare tire lock

* 2 keys included

trailer hitches & accessories

CURT™ Accessories

Help keep your hitches clean from foreign debris for optimal performance. Select from receiver and ball covers, to safety chain assemblies and quick links.



Scan for pricing or go to www.delcity.net/catalogpricing



CURT22101

receiver tube covers

part no.	description
CURT21901	chrome steel receiver cover for 1 1/4" x 1 1/4" receiver tube
CURT22101	chrome steel receiver cover for 2" x 2" receiver tube
CURT22111	chrome steel receiver cover for 2" x 2" receiver tube
CURT22751	black steel receiver cover for 2" x 2" receiver tube
CURT22171	chrome plastic cover for 2" x 2" receiver tube
CURT22181	black plastic cover for 2" x 2" receiver tube
CURT22275*	black rubber cover for 1 1/4" x 1 1/4" receiver tube
CURT22276*	black rubber cover for 2" x 2" receiver tube

* No pin and clip required

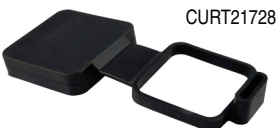

CURT21728

receiver cover

part no.	description
CURT21728	black rubber cover for 2" x 2" receiver tube w/4-way flat connector cover

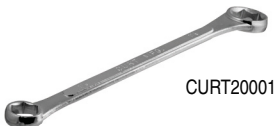

CURT20001

trailer ball hex wrench

part no.	description
CURT20001	1 1/8" & 1 1/2" ends for use with 3/4" & 1" shanks



CURT45007

ball mount tongue sleeve

part no.	description
CURT45007	for 2 1/2" ball mount tongue and wrench flat trailer ball



CURT41353

Switch Ball™ covers

part no.	description
CURT41350	black storage case
CURT41352	black, 3/4" shank cover
CURT41353	red, 3/4" shank cover
CURT41354	black, 1" shank cover
CURT41355	red, 1" shank cover



CURT21801

trailer ball cover

part no.	description
CURT21801	black cover for 1 7/8" and 2" ball
CURT21811	black cover for 2 5/16" ball



CURT80010

safety chains

part no.	description	min break force lbs	chain	length
CURT80136	nylon coated safety cables (pair), packaged	3,500	—	40"
CURT80151	nylon coated safety cables (pair), packaged	5,000	—	40"
CURT80176	nylon coated safety cables (pair), packaged	7,500	—	40"
CURT80011	metal chains with 2 3/8" S-hooks, packaged	2,000	3/16" x 41"	48"
CURT80031	metal chains with 2 7/8" S-hooks, packaged	5,000	1/4" x 40"	48"
CURT80010	metal chains with 2 3/8" S-hooks, bulk	2,000	3/16" x 41"	48"
CURT80030	metal chains with 2 7/8" S-hooks, bulk	5,000	1/4" x 40"	48"



Scan for pricing or go to www.delcity.net/catalogpricing



CURT82931 CURT82610

quick clips

part no.	description	max load lbs
CURT82611	1/4" threaded clip, packaged	220
CURT82901	5/16" threaded clip, packaged	440
CURT82933	3/8" threaded clip, packaged	660
CURT82610	1/4" threaded clip, bulk	220
CURT82900	5/16" threaded clip, bulk	440
CURT82930	3/8" threaded clip, bulk	660
CURT82931	7/16" threaded clip, bulk	880
CURT82932	1/2" threaded clip, bulk	1,100

safety hocks



CURT81266

part no.	description	max load lbs
CURT81261	3/8" safety latch, packaged	2,000
CURT81271	7/16" safety latch, packaged	5,000
CURT81281	9/16" safety latch, packaged	5,000
CURT81266	3/8" safety latch, bulk	2,000
CURT81277	7/16" safety latch, bulk	5,000
CURT81288	9/16" safety latch, bulk	5,000

fish wire

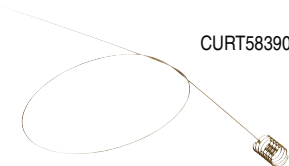

CURT58390

part no.	description
CURT58390	3/8" fish wire
CURT58400	1/2" fish wire
CURT58410	7/16" fish wire
CURT58430	5/8" fish wire

bearing protectors



CURT22178

part no.	description
CURT22178	for 1.78" hub bore diameter, 2 per pack w/dust cover
CURT22198	for 1.98" hub bore diameter, 2 per pack w/dust cover
CURT22232	for 2.32" hub bore diameter, 2 per pack w/dust cover
CURT22244	for 2.44" hub bore diameter, 2 per pack w/dust cover

rubber bearing dust covers



CURT23178

part no.	description
CURT23178	for 1.78" hub bore diameter, 2 per pack
CURT23198	for 1.98" hub bore diameter, 2 per pack
CURT23232	for 2.32" hub bore diameter, 2 per pack
CURT23244	for 2.44" hub bore diameter, 2 per pack

reducer bushings



CURT21100

part no.	description
CURT21101	1" to 3/4" reducer, packaged
CURT21201	1 1/4" to 1" reducer, packaged
CURT21301	1 3/8" to 1 1/4" reducer, packaged
CURT21100	1" to 3/4" reducer, bulk
CURT21200	1 1/4" to 1" reducer, bulk
CURT21300	1 3/8" to 1 1/4" reducer, bulk

trailer hitches & accessories



CURT22315

anti-rattle kits

part no.	description
CURT22315	1 1/4" plastic ant-rattle kit
CURT22321	2" yellow zinc anti-rattle kit
CURT23590	5/8" diameter lock w/M16-2.0 threads



Scan for pricing or go to www.delcity.net/catalogpricing



CURT22411

tow hooks

part no.	description	GTW lbs
CURT22401	heavy-duty, chrome tow hook, packaged	10,000
CURT22411	heavy-duty, black tow hook, packaged	10,000
CURT22420	heavy-duty, chrome tow hook, bulk	10,000
CURT22430	heavy-duty, black tow hook, bulk	10,000

* Hooks include all hardware.



CURT20002

tow mirror

part no.	description
CURT20002	adjustable, 4" to 11 1/2" tall extended mirror



CURT22200

tow pouch

part no.	description
CURT22200	17 1/2" x 11 1/2" tow pouch



CURT22322

finishing pack

part no.	description
CURT22322	panel, threshold retainers and plugs, 50 pcs

trailer hitches & accessories

Under-bed Double Lock Gooseneck Hitches

Help keep your hitches clean from foreign debris for optimal performance. Choose from receiver and ball covers, to safety chain assemblies and quick links.



Scan for pricing or go to www.delcity.net/catalogpricing



CURT60600

under-bed double lock gooseneck

part no.	description	GTW/TW lbs
CURT60607	gooseneck hitch for 2011 Chevrolet 2500/3500.	30,000/6,000
CURT60615	gooseneck hitch for '07-08 new body Chevrolet 1500 only	30,000/6,000
CURT60620	gooseneck hitch for Nissan Titan only	30,000/6,000
CURT60625	gooseneck hitch for Toyota Tundra only	30,000/6,000



CURT60602

under-bed gooseneck accessories

part no.	description
CURT60602	4" offset ball
CURT60603	1" high-rise ball
CURT60606*	install tool

* For use with CURT60607, CURT60615, CURT60620 and CURT60625



CURT60630

under-bed quick goose II gooseneck

part no.	description	GTW/TW lbs
CURT60630	goose II hitch for use with under-bed install kit	30,000/6,000
CURT60640	goose II hitch for use with most Dodge Ram trucks	30,000/6,000



CURT61652

under-bed quick goose II gooseneck

part no.	description	GTW/TW lbs
CURT61652	2 ⁵ / ₁₆ " folding ball hitch	30,000/6,000

trailer hitches & accessories

Under-bed Installation Kits



The under-bed installation kits are designed to be used with the CURT Double Lock Gooseneck, CURT Quick Goose II Gooseneck or CURT Folding Ball Gooseneck hitches. They fit on multiple vehicles and are rated to the vehicle's max gross towing weight. All components are laser cut for precise fit and have easy to follow installation instructions.



Scan for pricing or go to www.delcity.net/catalogpricing

make/model	style	years	double lock	goose II	rail kits	notes
CHEVERLOT/GMC						
1500 & 2500LD Silverado/Sierra	new body, 69.3", 78.7" & 97.6" beds	11-Jul	CURT60615	—	CURT60632	no drilling
	classic body only	99-07	—	CURT60630	CURT60652	no drilling
2500HD & 3500 Silverado/Sierra	long and short beds	2011	CURT60607	—	CURT60604	no drilling
	classic and new body	10-Jan	—	CURT60630	CURT60652	no drilling, 4
2500 & 3500	old body, long and short beds	99-00	—	CURT60630	CURT60631	no drilling
Ful Size Pickup Trucks	not 34" frame (O.D.)	88-98	—	CURT60630	CURT60631	no drilling
DODGE						
Ram 1500	all beds	09-11	—	—	CURT60657	no drilling
		09-10	—	—	—	no drilling
		02-08	—	CURT60640	CURT60659	no drilling, 1, 2
	all	94-01	—	CURT60640	CURT60635	no drilling
Ram 2500 & 3500	all beds	03-11	—	CURT60640	CURT60659	no drilling, 1, 2
	all	94-02	—	CURT60640	CURT60635	no drilling
FORD						
F-150	all beds	04-11	—	CURT60630	CURT60641	no drilling
		97-03	—	CURT60630	CURT60637	no drilling
		80-96	—	CURT60630	CURT60636	no drilling, 1
	heritage edition only	2004	—	CURT60630	CURT60637	no drilling
F-250 Light Duty	all	97-03	—	CURT60630	CURT60637	no drilling
F-250 & F-350 Super Duty	all	11-12	—	CURT60630	CURT60644	no drilling, 3
	including air bag overload	99-10	—	CURT60640	CURT60644	no drilling, 3
		99-10	—	CURT60640	—	no drilling, 3
F-250 & F-350	without overload springs	80-98	—	CURT60630	CURT60636	no drilling
	with overload springs	80-98	—	CURT60630	CURT60636	
F-450 Super Duty	all except cab and chasis	08-12	—	CURT60640	CURT60644	no drilling, 3
		0810	—	CURT60640	—	no drilling, 3
NISSAN						
Titan	along and short beds	04-11	CURT60620	—	CURT60664	no drilling, 1
Tundra	all beds	00-06	CURT60625	—	CURT60665	no drilling, 6

All Models: Brake, fuel and electrical lines may need to be loosened or repositioned. Heat shield requires modification or removal.

1. Passengers side wheel well must be noticed for frame rail access
2. Parking brake cable bracket may require relocation.
3. Exhaust may have to be permanently lowered on '05 and newer models.
4. Vacuum canister requires relocation (kit included).
5. Ball cannot be turned over, brake lines must be cable tied (ties included).
6. Do not invert ball with heavy loads on 2 wheel drive models.

trailer hitches & accessories

Over-Bed Folding Ball Gooseneck

This durable, folding ball gooseneck hitch has a gross towing weight of 30,000 lbs, with a tongue weight of 6,000 lbs. The stainless steel safety pin and pivot spring prevents binding. Installation is made easy with hardware, cutting template and instructions all included. See page 208 for the install kit.

part no.	description	GTW/TW lbs
CURT61052	2 ⁵ / ₁₆ " folding ball hitch	30,000/6,000

Over-Bed Fixed Ball Gooseneck

This durable, fixed ball gooseneck hitch has a gross towing weight of 30,000 lbs, with a 2⁵/₁₆" ball. It features a carbide powder coat finish. Over-bed reinforcement is required to reach max GTW rating to prevent binding. See page 208 for the install kit.

part no.	description
CURT61100	2 ⁵ / ₁₆ " fixed ball gooseneck hitch
CURT66113	u-bolt replacement kit for CURT61100

Over-Bed Flat Plate Gooseneck

This durable, fixed ball gooseneck hitch is the only ready-to-install flat plate. It comes with D-rings and is rated to 30,000 lbs, with a 2⁵/₁₆" welded ball. Over-bed reinforcement required to reach max GTW rating and to prevent binding. See page 208 for the install kit.

part no.	description	GTW/TW lbs
CURT65500	13" x 46" hitch plate	30,000

Over-Bed Bent Plate Gooseneck

This durable, bent plate is rated up to 30,000 lbs, with a 1¹/₄" ball hole. See page 208 for the install kit.

part no.	description	GTW/TW lbs
CURT65300	2 ¹ / ₂ " x 18 ¹ / ₄ " x 48" bent plate, raw finish	25,000
CURT65400	2 ¹ / ₂ " x 18 ¹ / ₄ " x 48" bent plate, carbide finish	25,000
CURT66113	safety chain, u-bolt kit, zinc	—
CURT40041	commercial-duty, 2 ⁵ / ₁₆ " x 1 ¹ / ₄ " x 2 ¹ / ₄ " ball, raw finish	30,000



Scan for pricing or go to www.delcity.net/catalogpricing



CURT61052



CURT61100



CURT65500



CURT65400

trailer hitches & accessories



Over-bed Installation Kits

The over-bed installation kits are designed to be used with the CURT Folding Ball Gooseneck, CURT Fixed Ball Gooseneck, CURT Flat Plate Goosenecks and CURT Bent Plate Goosenecks. They fit multiple vehicles and are available in 20,000 lbs. or 30,000 lbs ratings. Kits include grade 5 mounting hardware and all components are laser cut for precise fit and have easy to follow installation instructions.



Scan for pricing or go to www.delcity.net/catalogpricing

make/model	style	years	20K	30K	notes
CHEVERLOT/GMC					
1500 C/K Series	long bed	88-98	CURT61103	CURT61503	—
	short bed	88-98	CURT61104	CURT61504	—
1500 Silverado/Sierra Series	new body only, all beds	07-10	CURT61231	CURT61331	—
	classic body, all beds	99-07	CURT61241	CURT61341	no drilling
2500 & 3500 C/K Series	long bed (old body)	99-00	CURT61103	CURT61503	—
	long bed	88-00	CURT61103	CURT61503	—
	short bed (old body)	99-00	CURT61104	CURT61504	—
2500HD/3500 Silverado/Sierra	short bed	88-00	CURT61104	CURT61504	—
	all beds	2011	CURT61200	CURT61301	no drilling
	new and classic body	01-10	CURT61241	CURT61341	no drilling
2500 Light Duty Silverado/Sierra	classic body, all beds	99-07	CURT61241	CURT61341	no drilling
DODGE					
Ram 1500	all beds	02-08	CURT61219	CURT61319	no drilling
		94-01	CURT61109	CURT61509	—
Ram 2500 & 3500	all beds	03-11	CURT61129	—	—
		94-02	CURT61109	—	—
FORD					
F-150	all beds	04-11	CURT61221	CURT61321	no drilling
		80-96	CURT61105	CURT61505	—
		97-03	CURT61106	CURT61506	—
F-250/350	heritage edition only	2004	CURT61106	CURT61506	—
	with and without overload springs	97-98	CURT61105	CURT61505	—
F-250/350 Super Duty	all	80-96	CURT61105	CURT61505	—
	all beds	99-11	CURT61232	CURT61332	no drilling
F-450 Super Duty	all except cab and chasis	08-11	CURT61232	CURT61332	no drilling
TOYOTA					
Tundra	short bed only	07-11	CURT61225	—	DO NOT exceed recommended vehicle towing capacity
UNIVERSAL					
Universal Rail Kit	raw finish	—	CURT61102	CURT61502	—

X5 5th wheel adapter double lock plate



CURT65500

part no.	description
CURT16210	adapter plate, round style for CURT products
CURT16310	adapter plate, square style for competitive products

5th wheel rail spyder gooseneck



CURT16085

part no.	description
CURT16085	spyder gooseneck, 2 ⁵ / ₁₆ " welded ball, carbide finish

5th wheel bent plate gooseneck



CURT16085

part no.	description	GTW/TW lbs
CURT16055	bent plate gooseneck, 2 ⁵ / ₁₆ " ball w/3" offset	25,000

trailer hitches & accessories

CURT™ Specialized Towing

Del City offers the full line of Curt™ specialized towing products. These products help keep your trailer from swaying back and forth. Select from heavy-duty ball alternatives and jacks.



Scan for pricing or go to www.delcity.net/catalogpricing



CURT13702



CURT19100



CURT19745



CURT48323

class III RV receiver hitches

part no.	description	GTW/TW lbs
CURT13701	adjustable RV hitch up to 51" wide, 2" drop, 2" x 2" receiver tube	5,000/500
CURT13702	adjustable RV hitch up to 51" wide, 2" x 2" receiver tube	5,000/500
CURT13703	adjustable RV hitch up to 72" wide, 2" x 2" receiver tube	3,500/350

RV bumper hitch

part no.	description	GTW/TW lbs
CURT19100	4" square channel bumper hitch	3,500/350
CURT19101	2" square channel bumper hitch	3,500/350

adjustable tow bar

part no.	description	capacity lbs
CURT19745	26" to 41" adjustable tow bar, packaged	5,000
CURT19749	¼" x 60" coated safety chains w/latch hooks, packaged	5,000
CURT21501	5/8" replacement pin and clip, packaged	—
CURT19747	bumper brackets, bulk	—
CURT21500	5/8" replacement pin and clip, bulk	—

adjustable pintle mounts

part no.	description	drop (max)	rise (max)	length	plate height	GTW lbs
CURT48323	heavy-duty, 3 position pintle mount, for 2" x 2" shank	6½"	½"	8½"	7"	10,000
CURT48324	heavy-duty, 3 position pintle mount, for 2" x 2" shank	6½"	½"	10½"	7"	10,000
CURT48341	heavy-duty, 3 position pintle mount, for 2" x 2" shank	11½"	6"	12½"	13"	10,000
CURT48342	heavy-duty, 3 position pintle mount, for 2" x 2" shank	11½"	6"	14½"	13"	10,000
CURT48328	xtra-duty, 3 position pintle mount, for 2" x 2" shank	6½"	½"	8½"	7"	15,000
CURT48325	xtra-duty, 3 position pintle mount, for 2" x 2" shank	6½"	½"	10½"	7"	15,000
CURT48326	xtra-duty, 3 position pintle mount, for 2" x 2" shank	3"	—	8½"	3½"	20,000
CURT48327	xtra-duty, 3 position pintle mount, for 2" x 2" shank	3"	—	10½"	3½"	20,000
CURT48330*	bolt kit for pintle mount	—	—	—	—	—

* Kit includes 4 each of the following grade 8 pieces: ½" - 13 x 2" hex bolts, ½" - 13 hex nuts, ½" lock washers

trailer hitches & accessories

adjustable pintle mounts



CURT48329

part no.	description	drop (max)	rise (max)	length	plate height	GTW lbs
CURT48329	commercial-duty, 3 position pintle mount, for 2½" x 2½" shank	6½"	½"	12½"	7"	18,000
CURT48340	commercial-duty, 3 position pintle mount, for 2½" x 2½" shank	3"	—	12½"	3½"	20,000
CURT48330	bolt kit for pintle mount	—	—	—	—	—

* Kit includes 4 each of the following grade 8 pieces: ½" – 13 x 2" hex bolts, ½" – 13 hex nuts, ½" lock washers



Scan for pricing or go to www.delcity.net/catalogpricing

adjustable lunette eyes



CURT48630

part no.	description	dimensions	GTW lbs
CURT48630	heavy-duty, 3" ID eyelet, 3 position, packaged	3½" x 7½" w/2" bolt pattern spread	12,000
CURT48600	heavy-duty, 3" ID eyelet, 3 position, bulk	2" bolt pattern spread	12,000
CURT48660	xtra-duty, 3" ID eyelet, 3 position, bulk	2" bolt pattern spread	24,000
CURT48610	3 position channel only, bulk	3½" x 6"	—
CURT48650	5 position channel only, bulk	3½" x 10"	—
CURT48640	heavy-duty, 3" eyelet, 3 position, bulk	3½" x 11¾" channel w/2" bolt pattern spread	12,000
CURT48620	bolt and nut kit	—	—

4-bolt mount lunette eyes

CURT48550



part no.	description	dimensions	GTW lbs
CURT48550	heavy-duty, 2½" ID steel lunette eye	4½" on center, 6" square base	35,000
CURT48560	heavy-duty, 3" ID steel lunette eye	4½" on center, 6" square base	60,000

lunette eyes with mounting hardware

CURT48520



part no.	description	GTW lbs
CURT48520	xtra-duty, 2½" ID, steel lunette eye	15,000
CURT48530	xtra-duty, 3" ID, steel lunette eye	45,000

lunette eyes with mounting hardware

CURT48510



part no.	description	GTW lbs
CURT48510	heavy-duty, 3" ID, flat steel lunette eye	22,000

4-bolt mount lunette eyes

CURT48205



part no.	description	vehicle load lbs	capacity lbs
CURT48205	heavy-duty, regular pintel, carbide finish	2,000	10,000
CURT48210	xtra-duty, regular pintel, carbide finish	4,000	20,000
CURT48215	xtra-duty, regular pintel, carbide finish	8,000	30,000
CURT48230	xtra-duty, regular pintel, carbide finish	12,000	60,000

receiver pintle hooks



CURT48004

part no.	description	lunette eye ID	length	capacity lbs
CURT48005	heavy-duty pintle, 2" x 2" receiver tube, gloss black	2½"	14½"	10,000
CURT48004	xtra-duty pintle, 2" x 2" receiver tube, gloss black	2½"	14½"	20,000
CURT48003	xtra-duty pintle, 2" x 2" receiver tube, gloss black	2½"	14½"	30,000
CURT48002	xtra-duty pintle, 2" x 2" receiver tube, gloss black	2½"	14¾"	40,000

trailer hitches & accessories



Scan for pricing or go to www.delcity.net/catalogpricing



CURT48180

ball and pintle hooks

part no.	description	lunette eye ID	pintle capacity lbs	ball capacity lbs
CURT48180	xtra-duty, 1 ⁷ / ₈ " forged ball and pintle, gloss black	2 ¹ / ₂ "-3"	16,000	6,000
CURT48190	xtra-duty, 2" forged ball and pintle, gloss black	2 ¹ / ₂ "-3"	16,000	10,000
CURT48200	xtra-duty, 2 ⁵ / ₁₆ " forged ball and pintle, gloss black	2 ¹ / ₂ "-3"	16,000	12,000
CURT48330	hardware kit	—	—	—

ball and pintle hooks



CURT48006

part no.	description	lunette eye ID	length	pintle capacity lbs	ball capacity lbs	ball dia.
CURT48006	xtra-duty, pintle combo, for 2" x 2" receiver tube, gloss black	2 ¹ / ₂ "-3"	15 ¹ / ₄ "	16,000	12,000	2 ⁵ / ₁₆ "
CURT48007	xtra-duty, pintle combo, for 2" x 2" receiver tube, gloss black	2 ¹ / ₂ "-3"	15 ¹ / ₄ "	16,000	10,000	2"

replacement pintle balls



CURT48810

part no.	description	ball capacity lbs	ball dia.
CURT48810	replacement pintle ball, for 1 ¹ / ₄ " shank, chrome finish	6,000	1 ⁷ / ₈ "
CURT48820	replacement pintle ball, for 1 ¹ / ₄ " shank, chrome finish	10,000	2"
CURT48830	replacement pintle ball, for 1 ¹ / ₄ " shank, chrome finish	12,000	2 ⁵ / ₁₆ "

sway control



CURT17200

part no.	description
CURT17200	kit to include all necessary components for sway control
CURT17201	trailer mounted attachment ball
CURT40093	sway control hitch ball
CURT45820	sway tab ball mount
CURT45822	weld-on sway tab

weight distribution hitches



CURT17000

part no.	description	bar style	GTW/TW lbs
CURT17000	weight distribution kit w/12" shank	round bar	10,000/600
CURT17001	weight distribution kit w/12" shank	round bar	10,000/800
CURT17002	weight distribution kit w/12" shank	round bar	10,000/1,000
CURT17330	weight distribution kit w/12" shank	trunnion bar	10,000/600
CURT17331	weight distribution kit w/12" shank	trunnion bar	10,000/800
CURT17332	weight distribution kit w/12" shank	trunnion bar	10,000/1,000
CURT17300	weight distribution kit w/12" shank	long trunion bar	10,000/600
CURT17301	weight distribution kit w/12" shank	long trunion bar	10,000/800
CURT17302	weight distribution kit w/12" shank	long trunion bar	10,000/1,000

WD replacement spring bars



CURT17104

part no.	description	bar style	TW lbs
CURT17104	spring bar w/2 chain fasteners	round	600
CURT17105	spring bar w/2 chain fasteners	round	800
CURT17106	spring bar w/2 chain fasteners	round	1,000
CURT17304	spring bar w/2 chain fasteners	long trunion	600
CURT17305	spring bar w/2 chain fasteners	long trunion	800
CURT17306	spring bar w/2 chain fasteners	long trunion	1,000

trailer hitches & accessories

replacement hardware



CURT17109

part no.	description
CURT17109	round bar retainer (2 clips, pins & rivets)
CURT17114	1" rivet for round bar
CURT17150	bolt kit for round bar hitch
CURT17312	head angle adjustment upgrade kit
CURT17314	conical washers, set of 4
CURT17350	bolt kit for trunnion style WD hitch



Scan for pricing or go to www.delcity.net/catalogpricing

WD replacement shank



CURT48180

part no.	description	drop max	rise max	length
CURT17100	black replacement shank	2"	6"	12"
CURT17102	black replacement shank	2"	6"	14"
CURT17103	black replacement shank	2"	6"	16"
CURT17120	black replacement shank	5 ⁵ / ₈ "	8 ⁷ / ₈ "	12"
CURT17121	black replacement shank	6"	10 ¹ / ₄ "	14"
CURT17122	black replacement shank	6"	10 ¹ / ₄ "	16"
CURT17123	black replacement shank	7"	10 ¹ / ₂ "	9"
CURT17124	black replacement shank	8 ³ / ₄ "	—	11"
CURT17125	black replacement shank	14 ¹ / ₂ "	—	10"

WD replacement hook-up brackets



CURT17112

part no.	description
CURT17112	lift handle

WD replacement chain & u-bolts



CURT17111

part no.	description
CURT17111	hardware replacement parts, ³ / ₈ " lock-nuts, washers, chains and u-bolts

WD replacement chain & u-bolts



CURT17107

part no.	description
CURT17107	round bar replacement head
CURT17307	trunnion bar replacement head

posi-lock couplers



CURT25128

part no.	description	GTW/TW lbs
CURT25128	coupler, 1 ⁷ / ₈ " ball, 2" channel	2,000/200
CURT25105	coupler, 1 ⁷ / ₈ " ball, 2 ¹ / ₂ " channel	2,000/200
CURT25131	coupler, 1 ⁷ / ₈ " ball, 3" channel	2,000/200
CURT25153	coupler, 2" ball, 2" channel	3,500/500
CURT25135	coupler, 2" ball, 2 ¹ / ₂ " channel	3,500/500
CURT25138	coupler, 2" ball, 3" channel	3,500/500
CURT25100	coupler, 2" ball, 3" channel	5,000/700



Scan for pricing or go to www.delcity.net/catalogpricing



CURT25101

A-frame couplers

part no.	description	bar style	TW lbs
CURT25101	2" ball, A-frame coupler, zinc finish	posi-lock	5,000/700
CURT25210	2" ball, A-frame coupler, black finish	posi-lock	5,000/700
CURT25200	heavy-duty, 2 ⁵ / ₁₆ " ball, A-frame coupler, black finish	easy-lock	10,000/1,500



CURT25217

sleeve-lock A-frame couplers

part no.	description	GTW/TW lbs
CURT25217	2" ball A-frame coupler	7,000/1,050
CURT25227	heavy-duty, 2 ⁵ / ₁₆ " ball A-frame coupler	12,500/1,875



CURT25319

adjustable sleeve-lock channel couplers

part no.	description	GTW/TW lbs
CURT25319	2" ball adjustable sleeve-lock coupler, black	7,000/1,050
CURT25329	heavy-duty, 2 ⁵ / ₁₆ " ball adjustable sleeve-lock coupler, black	12,500/1,875
CURT25328	heavy-duty, 2 ⁵ / ₁₆ " ball adjustable coupler	15,000/2,250
CURT25388	hardware for adjustable couplers	—



CURT28101

marine jacks

part no.	description	bracket height	travel	wheel size	capacity lbs
CURT28101	marine jack, zinc finish, packaged	12 ¹¹ / ₁₆ "	10"	6"	1,000
CURT28113	marine jack, zinc finish, packaged	12 ¹¹ / ₁₆ "	10"	6"	1,200
CURT28114	marine jack, 600 salt spray resistant zinc finish, packaged	12 ¹¹ / ₁₆ "	10"	6"	1,200
CURT28116	marine jack, zinc finish, packaged	12 ¹¹ / ₁₆ "	10"	8"	1,500
CURT28118	marine jack, 600 salt spray resistant zinc finish, packaged	12 ¹¹ / ₁₆ "	10"	6"	1,500
CURT28156	marine jack, zinc finish, packaged	12 ¹ / ₂ "	12"	dual 6"	1,500
CURT28100	marine jack, zinc finish, packaged	12 ¹¹ / ₁₆ "	10"	6"	1,000
CURT28112	marine jack, zinc finish, packaged	12 ¹¹ / ₁₆ "	10"	6"	1,200
CURT28115	marine jack, zinc finish, packaged	12 ¹¹ / ₁₆ "	10"	8"	1,500
CURT28155	marine jack, zinc finish, packaged	12 ¹ / ₂ "	12"	dual 6"	1,500



CURT28200

A-frame jacks

part no.	description	wind	bracket height	travel	capacity lbs
CURT28203	A-frame jack, black handle, packaged	top	9"	15"	2,000
CURT28200	A-frame jack, black handle	top	8"	14"	2,000
CURT28202	A-frame jack, black handle	top	9"	15"	2,000
CURT28204	A-frame jack, black handle	side	9"	14 ¹ / ₂ "	2,000
CURT28250	A-frame jack, black handle	top	10 ¹ / ₂ "	14"	5,000
CURT28255	A-frame jack, red claw	top	12 ¹ / ₂ "	15"	5,000

trailer hitches & accessories

pipe mount swivel jacks



CURT28320

part no.	description	wind	bracket height	travel	capacity lbs
CURT28323	weldable, pull pin swivel jack, red claw, packaged	top	15"	9/16"	2,000
CURT28351	weldable, pull pin swivel jack, red claw, packaged	top	10"	9/16"	5,000
CURT28320	weldable, pull pin swivel jack, red claw, bulk	top	10"	9/16"	2,000
CURT28321	weldable, pull pin swivel jack, black handle, bulk	side	10"	9/16"	2,000
CURT28322	weldable, pull pin swivel jack, red claw, bulk	top	15"	9/16"	2,000
CURT28324	weldable, pull pin swivel jack, black handle, bulk	side	15"	9/16"	2,000
CURT28350	weldable, pull pin swivel jack, red claw, bulk	top	10"	9/16"	5,000
CURT28354	weldable, pull pin swivel jack, black handle, bulk	side	10"	5/8"	5,000
CURT28356	weldable, pull pin swivel jack, red claw, bulk	top	15"	5/8"	5,000
CURT28358	weldable, pull pin swivel jack, black handle, bulk	side	15"	5/8"	5,000



Scan for pricing or go to www.delcity.net/catalogpricing



CURT28302

bracket mount swivel jacks

part no.	description	wind	travel	capacity lbs
CURT28301	weldable swivel jack, red claw, packaged	top	10"	2,000
CURT28305	weldable swivel jack, red claw, packaged	top	15"	2,000
CURT28300	weldable swivel jack, red claw, bulk	top	10"	2,000
CURT28302	weldable swivel jack, black handle, bulk	side	10"	2,000
CURT28304	weldable swivel jack, red claw, bulk	top	15"	2,000
CURT28306	weldable swivel jack, black handle, bulk	side	15"	2,000

adjustable sleeve-lock channel couplers



CURT28272



CURT28276

part no.	description	GTW/TW lbs
CURT28271	jack foot for 2" tube, bolt on	2,000
CURT28273	jack foot for 2" tube, 1 ¹¹ / ₁₆ " tall	2,000
CURT28275	jack foot for 2" tube, 8.5" tall	2,000
CURT28277	caster assembly w/6" x 2" poly wheel, 2" tube	1,200
CURT28279	3/8" safety pin	—
CURT28270	jack foot for 2" tube, bolt on	2,000
CURT28272	jack foot for 2" tube, 1 ¹¹ / ₁₆ " tall	2,000
CURT28274	jack foot for 2" tube, 8.5" tall	2,000
CURT28276	caster assembly w/6" x 2" poly wheel, 2" tube	1,200
CURT28278	3/8" safety pin	—

direct weld jacks



CURT28570

part no.	description	wind	travel	support capacity lbs	lift capacity lbs
CURT28512	heavy-duty, direct weld jack w/spring return, black handle	side	12 ¹ / ₂ "	12,000	10,000
CURT28570	direct weld drop leg jack, red claw	top	15"	8,000	7,000
CURT28575	direct weld drop leg jack, black handle	side	15"	8,000	7,000

universal weld hitch



CURT15901

part no.	description	drop	width min	width max	GTW/TW lbs
CURT15901	heavy-duty, weld-on hitch, class v rated, 2" x 2" receiver tube	5"	18"	43"	12,000/1,200
CURT15902	heavy-duty, weld-on hitch, class v rated, 2" x 2" receiver tube	13 ¹ / ₂ "	18"	43"	12,000/1,200
CURT15903	extra-duty, weld-on hitch, class v rated, 2" x 2" receiver tube	13 ¹ / ₂ "	18"	60"	15,000/1,500

joining hooks



CURT82943



CURT82940

part no.	description
CURT82940	9/0 joining link, raw finish
CURT82942	7/16" joining link, raw finish
CURT82943	9/0 joining link, zinc finish
CURT82944	7/16" joining link, zinc finish

trailer hitches & accessories



Scan for pricing or go to www.delcity.net/catalogpricing



CURT81810



CURT81840



CURT82930



CURT81360



CURT81560



CURT81330

certified S-hooks

part no.	description	SAE class	diameter	GTW/TW lbs
CURT81260	s-hook, zinc plated	1	3/8"	2,000
CURT81640	s-hook, zinc plated	2	13/32"	3,500
CURT81270	s-hook, zinc plated	3	7/16"	5,000
CURT81620	s-hook, zinc plated	4	17/32"	7,600

* S-hooks must meet or exceed the max GTW of your trailer

latched S-hooks

part no.	description	SAE class	diameter	GTW/TW lbs
CURT81810	s-hook, zinc plated	1	3/8"	2,000
CURT81840	s-hook, zinc plated	2	13/32"	3,500
CURT81820	s-hook, zinc plated	3	7/16"	5,000
CURT81830	s-hook, zinc plated	4	17/32"	7,600

* S-hooks must meet or exceed the max GTW of your trailer

c-clips

part no.	description	max load lbs
CURT82611	1/4" threaded c-clip, packaged	220
CURT82901	5/16" threaded c-clip, packaged	440
CURT82933	3/8" threaded c-clip, packaged	660
CURT82610	1/4" threaded c-clip, bulk	880
CURT82900	5/16" threaded c-clip, bulk	440
CURT82930	3/8" threaded c-clip, bulk	660
CURT82931	7/16" threaded c-clip, bulk	880
CURT82932	1/2" threaded c-clip, bulk	1,100

snap hook

part no.	description	max load lbs
CURT81360	snap hook for 5/8" ID, zinc finish	

* Hook must meet or exceed the max GTW of your trailer

clevis hook w/safety latch

part no.	description	SAE class	diameter	GTW/TW lbs
CURT81900	1/4" safety hook w/latch	43	1/2"	7,800
CURT81940	1/4" safety hook w/latch	70	1/2"	12,600
CURT81550	5/16" safety hook w/latch	43	3/4"	14,000
CURT81950	5/16" safety hook w/latch	70	3/4"	18,000
CURT81560	3/8" safety hook w/latch	43	1"	18,000
CURT81960	3/8" safety hook w/latch	70	1"	24,000
CURT81970	7/16" safety hook w/latch	alloy	1 1/8"	40,000
CURT81910	1/2" safety hook w/latch	43	1 1/4"	35,000
CURT81980	1/2" safety hook w/latch	alloy	1 1/4"	48,000
CURT81920	5/8" safety hook w/latch	alloy	1 1/4"	65,000
CURT81999	replacement latch for CURT81950 & CURT81960	—	—	—

clevis hooks

part no.	description	grade	working load limit
CURT81330	1/4" clevis grab hook, white zinc finish	43	2,600
CURT81340	5/16" clevis grab hook, white zinc finish	43	3,900
CURT81350	3/8" clevis grab hook, white zinc finish	43	5,400
CURT81438	3/8" clevis grab hook, yellow zinc finish	70	6,600

trailer hitches & accessories

safety chains w/S-hooks



CURT80300

part no.	description	grade	min break force lbs	length
CURT80011	3/16" x 41" chain, with one 3/8" S-hook, pkgd	30	2,000	48"
CURT80031	1/4" x 40" chain, with one 7/16" S-hook, pkgd	30	5,000	48"
CURT80020	3/16" x 24" chain, with one 3/8" S-hook, bulk	30	2,000	27"
CURT80010	3/16" x 41" chain, with one 3/8" S-hook, bulk	30	2,000	48"
CURT80040	1/4" x 23" chain, with one 7/16" S-hook, bulk	30	5,000	27"
CURT80030	1/4" x 40" chain, with one 7/16" S-hook, bulk	30	5,000	48"
CURT80300	8/0" x 23" chain, with one 17/32" S-hook, bulk	30	7,000	27"
CURT80301	8/0" x 40" chain, with one 17/32" S-hook, bulk	30	7,000	48"

* Each chain must meet or exceed trailer GTW.



Scan for pricing or go to www.delcity.net/catalogpricing

safety chains w/clevis or latch S-hooks



CURT80302

part no.	description	grade	min break force lbs	length
CURT80312	3/16" x 24" chain, with one 3/8" S-hook	30	2,000	48"
CURT80313	1/4" x 24" chain, with one 7/16" S-hook	30	5,000	48"
CURT80314	5/16" x 24" chain, with one 5/16" S-hook	30	2,000	27"
CURT80315	3/8" x 24" chain, with one 31" hook	30	2,000	48"
CURT80316	3/8" x 31" chain, with one 3/8" hook	30	5,000	27"
CURT80302	1/4" x 32" chain, with one 3/8" hook	30	5,000	48"
CURT80303	1/4" x 32" chain, with one 3/8" hook	30	7,000	27"
CURT80304	5/32" x 24" chain, with one 3/8" hook	30	7,000	48"

* Each chain must meet or exceed trailer GTW.

transport binder safety chains



CURT80308

part no.	description	grade	min break force lbs	length
CURT80305	5/16" x 162" chain, with two 5/16" clevis hook	70	4,700	14'
CURT80306	5/16" x 186" chain, with two 5/16" clevis hook	70	4,700	16'
CURT80307	5/16" x 234" chain, with two 5/16" clevis hook	70	4,700	20'
CURT80308	5/16" x 294" chain, with two 5/16" clevis hook	70	4,700	25'
CURT80309	3/8" x 162" chain, with two 3/8" clevis hook	70	6,600	14'
CURT80310	3/8" x 186" chain, with two 3/8" clevis hook	70	6,600	16'
CURT80311	3/8" x 234" chain, with two 3/8" clevis hook	70	6,600	20'

* Each chain must meet or exceed trailer GTW.

bulk chain



CURT82120



CURT82135

part no.	description	type	grade	min break force lbs	total length
CURT82116	3/16" bulk chain, white zinc finish	proof coil	30	3200	per foot
CURT82165	5/0 bulk chain, white zinc finish	proof coil	30	3700	per foot
CURT82105	1/4" bulk chain, white zinc finish	proof coil	30	5200	per foot
CURT82170	8/0 bulk chain, white zinc finish	proof coil	30	7600	per foot
CURT82110	5/16" bulk chain, white zinc finish	proof coil	30	7600	per foot
CURT82115	3/8" bulk chain, white zinc finish	proof coil	30	10600	per foot
CURT82120	1/4" bulk chain, white zinc finish	high test	43	7800	per foot
CURT82125	5/16" bulk chain, white zinc finish	high test	43	11700	per foot
CURT82130	3/8" bulk chain, white zinc finish	high test	43	16200	per foot
CURT82135	1/4" bulk chain, yellow zinc finish	transport	43	12600	per foot
CURT82140	5/16" bulk chain, yellow zinc finish	transport	70	18800	per foot
CURT82145	3/8" bulk chain, yellow zinc finish	transport	70	26400	per foot
CURT82155	1/2" bulk chain, yellow zinc finish	transport	70	45200	per foot
CURT82158	1/2" bulk chain, raw finish	alloy	80	48000	per foot
CURT82160	5/8" bulk chain, yellow zinc finish	alloy	80	72400	per foot

trailer hitches & accessories



Scan for pricing or go to www.delcity.net/catalogpricing



CURT18030

Extended Hitch Mounted Bike Rack

Need extra room for your next trip? CURT™ cargo management accessories allow you to increase your storage capacity by simply using the roof of your vehicle or trailer hitch receiver.

part no.	description	# of bikes	max load lbs
CURT18030	extendable bike rack w/tilt function, 1¼" & 2" receiver tube	2-4	90/180

Hitch Mounted Bike Racks

Easily install and remove the bike rack utilizing only the hitch receiver. The adjustable rubber bike cradle will not scratch the bike frame and arm cradle folds down when not in use. The tilt function allows for rear vehicle access without the rack removal. The support strap and anti-wobble base helps provide rack stability during transport.



CURT18033

part no.	description	# of bikes	max load lbs
CURT18029	bike rack w/tilt function, 1¼" & 2" receiver tube	2	90
CURT18033	bike rack w/tilt function, 1¼" & 2" receiver tube	3	135
CURT18034	bike rack w/tilt function, 1¼" & 2" receiver tube	4	180



CURT18063

Premium Hitch Mounted Bike Rack

Easily install and remove the bike rack utilizing only the hitch receiver. The tapered arms allow mounting of smaller bike frames. An adjustable rubber bike cradle will not scratch the bike frame and the arm cradle folds down when not in use. The tilt function allows for rear vehicle access without rack removal. The anti-wobble base helps provide rack stability during transport.

part no.	description	# of bikes	max load lbs
CURT18063	bike rack w/tilt function, 2" receiver tube	2	135
CURT18064	bike rack w/tilt function, 2" receiver tube	3	180
CURT18064	bike rack w/tilt function, 2" receiver tube	4	225



CURT18013

Clamp-On Bike Rack

Easily install and remove the bike rack by clamping onto a 2" x 2" ball mount shank. An adjustable rubber bike cradle will not scratch the bike frame. Support straps included.

part no.	description	# of bikes	max load lbs
CURT18013	clamp-on bike rack, 2" x 2" receiver shank	3	135



CURT18019

Single Arm Bike Rack

Easily install and remove the bike rack utilizing only the hitch receiver. An adjustable rubber bike cradle will not scratch the bike frame and is lockable. The tilt function allows for rear vehicle access without rack removal. Accepts frame tubes up to 1¼".

part no.	description	# of bikes	max load lbs
CURT18019	single arm, lockable, 2" x 2" receiver shank	4	150

trailer hitches & accessories



CURT18011

Single Arm Bike Rack

Easily install and remove the bike rack utilizing the ball mount or step bumper. The coated bike cradle will not scratch the bike frame. The tilt function allows for rear vehicle access without rack removal.

part no.	description	# of bikes	max load lbs
CURT18011	single arm, tiltable, 3/4" bolt hole	2	70



Scan for pricing or go to www.delcity.net/catalogpricing

clamp-on mount bike rack



CURT18050

part no.	description
CURT23666	6' x 10mm cable lock w/lock and cinch features
CURT18002	anti-way bar, round tube, 4 position
CURT18005	anti-sway bar, square tube, 4 position
CURT18006	4 anti sway straps
CURT18050	bike rack support strap
CURT18016	adjustable bike beam for various bike frames

anti-rattle kits



CURT22315

part no.	description
CURT22315	1 1/4" mount, plastic anti-rattle kit
CURT22321	2" mount, yellow zinc anti-rattle kit
CURT23590	2" mount, 5/8" diam lock w/M16-2.0 threads

bolt-together cargo carriers

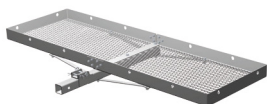

CURT18100

part no.	description	carrier dimensions	shank	capacity lbs
CURT18100	aluminum cargo carrier w/folding shank	60" x 20" x 2 3/4"	2" x 2"	500

* Folding carriers may interfere with rear-mounted spare tires.

basket style cargo carriers



CURT18131

part no.	description	carrier dimensions	shank	capacity lbs
CURT18145	basket cargo carrier, fixed shank, includes 2" adapter shank	48" x 20" x 6"	1 1/4" x 1 1/4" 2" adapter	500

* Folding carriers may interfere with rear-mounted spare tires.

universal ATV cargo carrier



CURT18101

part no.	description	carrier dimensions
CURT18101	ATV carrier basket	41" x 26" x 6 1/4"

trailer hitches & accessories



Scan for pricing or go to www.delcity.net/catalogpricing



CURT18115

roof mounted cargo carrier

part no.	description	carrier dimensions
CURT18115	roof rack	41½" x 37" x 4"
CURT18117	roof rack extension	21" x 37" x 4"



CURT18202

cargo net

part no.	description	dimensions
CURT18202	cargo net for 60" wide carriers	43" x 24"
CURT18200	roof rack cargo net	44" x 38"
CURT18201	extended roof rack cargo net	65" x 38"

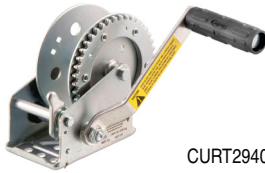

CURT29405

hand winch

part no.	description	gear ratio	broached pinion shaft	hub dia.	handle length	capacity lbs
CURT29403	hand winch	3.1:1	no	¾"	7"	900
CURT29404	hand winch	4.1:1	no	¾"	7"	1,200
CURT29405	hand winch	4.1:1	no	¾"	7"	1,400
CURT29407	hand winch	5.1:1	yes	1"	8"	1,700
CURT29408	hand winch	5.1:1	yes	1"	8"	1,900
CURT29409	hand winch	5.1:1	yes	1"	8"	2,100

* Broached pinion shafts securely engage the pinion gears.



CURT29007

winch strap

part no.	description	size	break strength lbs
CURT29007	black, nylon winch strap	2" x 20'	4,000



CURT83066

vehicle recover strap

part no.	description	size	break strength lbs
CURT83066	nylon tow strap	2" x 30'	18,000



CURT83049

cargo ratchet straps

part no.	description	size	break strength lbs
CURT83049	ratchet cargo strap with J-hooks	2" x 27'	10,000
CURT83050	ratchet cargo strap with flat hooks	2" x 27'	10,000
CURT83053	ratchet cargo strap with J-hooks	1" x 15'	3,000

trailer hitches & accessories

recessed floor & wall tie downs



CURT83607

part no.	description	capacity lbs
CURT83600	1/8" recessed tie down, zinc finish	5,000
CURT83607	steel backing plate for CURT83600, CURT83650 & CURT83740	—
CURT83650	3/16" recessed tie down, yellow zinc finish	7,500



Scan for pricing or go to www.delcity.net/catalogpricing

recessed rope ring



CURT83601

part no.	description	capacity lbs
CURT83601	3" x 3/8" recessed mounting ring	1,200

weld-on pocket anchor



CURT83072

part no.	description	dimensions
CURT83072	pocket anchor, raw finish	1 5/8" x 3 1/2" ID

recessed rope ring

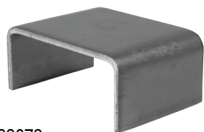

CURT83072

part no.	description	dimensions
CURT83710	1/4", 16-gauge, rope ring, zinc finish	1,000
CURT83720	black plastic trim for CURT83710	—

rope rings



CURT83730

part no.	description	diameter	capacity lbs
CURT83731	surface mounted rope ring, zinc finish, packaged	9/40"	1,200
CURT83730	surface mounted rope ring, zinc finish, bulk	9/40"	1,200
CURT83732	surface mounted rope ring, stainless finish, bulk	9/40"	1,200

forged lashing ring & brackets



CURT83750

part no.	description	dimensions	ring diameter	breaking strength lbs
CURT83750	D-ring w/ weld-on bracket	1 7/8" x 3/8"	5/8"	18,000

forged D-ring



CURT83740

part no.	description	inside diameter	capacity lbs
CURT83740	1/2" forged D-ring w/mounting bracket, yellow zinc finish	2 1/2" x 2 3/8"	11,000
CURT83742	1/2" forged D-ring w/mounting bracket, white zinc finish	2 1/2" x 2 3/8"	11,000
CURT83607	steel backing plate for CURT83600, CURT83650 & CURT83740	—	—
CURT83610	steel backing plate for CURT83740 & CURT83742	—	—

Wire Color Codes



Scan for pricing or go to www.delcity.net/catalogpricing

recreational vehicles 7-pole connectors

no.	color	circuits	recommended wire gauge
1	White	ground return	10 gauge
2	Blue	electric brake	12 gauge
3	Green	tail, license & running lights	14 gauge
4	Black	battery charge	10 gauge
5	Red	stop & left hand turn signal	14 gauge
6	Brown	stop & right hand turn signal	14 gauge
7	Yellow	auxiliary circuit	14 gauge

universal 6-pole connectors

no.	color	circuits
1	White	ground return
2	Brown	tail lights
3	Yellow	left turn
4	Red	stop
5	Green	right turn
6	Blue	auxiliary circuit

heavy-duty 7-pole connectors

no.	color	circuits	recommended wire gauge	FMVSS-121 anti-lock
1	White	ground return	10 gauge	8 gauge
2	Black	clearance, side marker & identification lamps	12 gauge	12 gauge
3	Yellow	left turn & hazard signal	12 gauge	12 gauge
4	Red	stop lamps & anti-lock devices	12 gauge	10 gauge
5	Green	right turn signal & hazard signal	12 gauge	12 gauge
6	Brown	tail, rear clearance, marker & license plate lamps	12 gauge	12 gauge
7	Blue	auxiliary circuit	12 gauge	12 gauge

universal 4-pole connectors

no.	color	circuits
1	White	ground return
2	Green	right turn & brake lights
3	Yellow or Red	left turn & brake lights
4	Brown	tail lights

INFORMATION

NOTE: Check all circuits before operating vehicle.

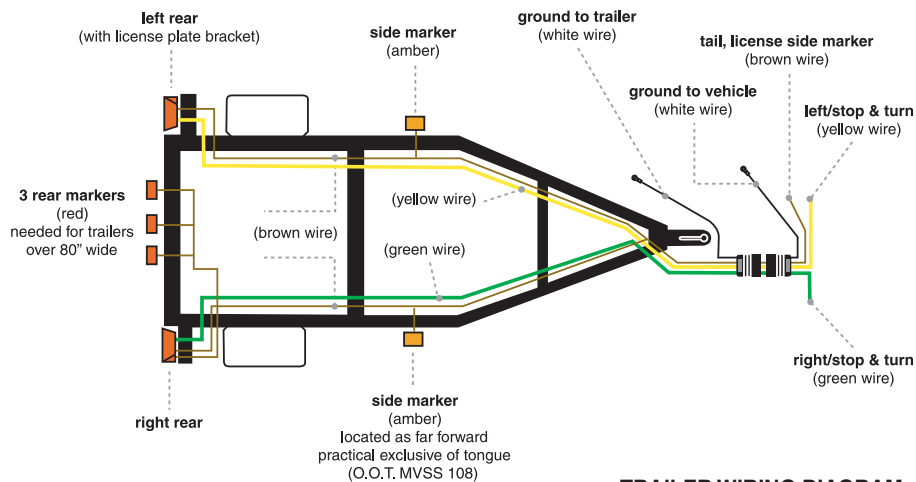

TRAILER WIRING DIAGRAM

trailer connectors

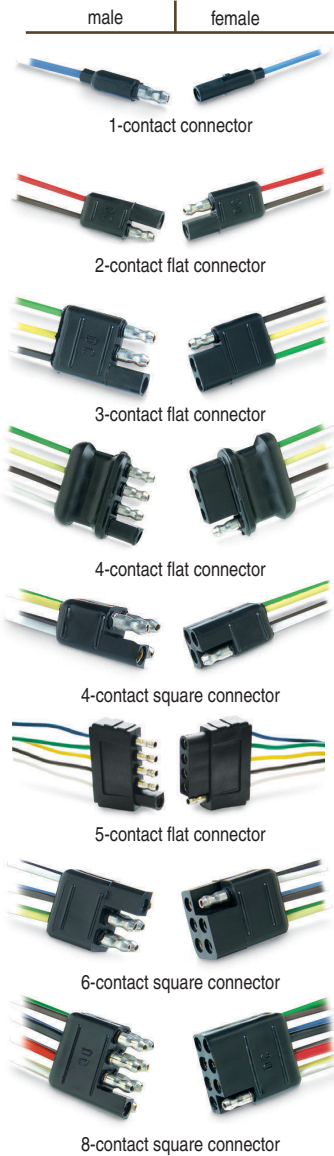

Molded Connectors

All molded connectors are manufactured with 16 gauge copper wire, except the 8-contact connector which is manufactured with 3–12 gauge and 5–16 gauge wires. All 4-contact flat connectors are molded with an Easy Grip® for fast and easy disconnect. Color coding in accordance with SAE recommended practice.



Scan for pricing or go to www.delcity.net/catalogpricing

SPECIAL NOTE

All male connectors are shown on the left and all female connectors are pictured on the right.
trailer = male tow vehicle = female

1-contact flat

part no.	description
74175	male end only with 8" of wire
74195	female end only with 8" of wire

4-contact square

part no.	description
74075	male end only with 8" of wire
74095	female end only with 8" of wire
74055	male end only with 48" of wire
74085	female end only with 48" of wire

2-contact flat

part no.	description
74275	male end only with 8" of wire
74295	female end only with 8" of wire
74255	male end only with 48" of wire
74285	female end only with 48" of wire
74245	female end only with 60" of wire

5-contact flat

part no.	description
74505	male end only with 8" of wire
74510	female end only with 8" of wire
74530	male end only with 48" of wire
74535	female end only with 48" of wire

3-contact flat

part no.	description
74375	male end only with 8" of wire
74395	female end only with 8" of wire
74355	male end only with 48" of wire
74385	female end only with 48" of wire

6-contact square

part no.	description
74675	male end only with 8" of wire
74695	female end only with 8" of wire
74655	male end only with 48" of wire
74685	female end only with 48" of wire

4-contact flat

part no.	description
74475	male end only with 8" of wire
74495	female end only with 8" of wire
74455	male end only with 48" of wire
74485	female end only with 48" of wire
74445	female end only with 60" of wire

8-contact square

part no.	description
74875	male end only with 8" of wire
74895	female end only with 8" of wire
74855	male end only with 48" of wire
74885	female end only with 48" of wire

Use With

pigtail plugs
PAGE 236

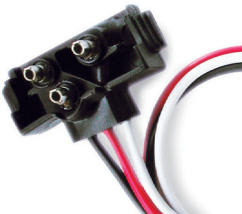

contacts	male end	wire colors	female end
* for 5, 6, and 8-contact molded connector configurations, see page 186			
2		1. brown 2. red	
3		1. green 2. yellow 3. brown	
4 flat		1. green 2. yellow 3. brown 4. white	
4 square		1. green 2. brown 3. yellow 4. white	



Scan for pricing or go to www.delcity.net/catalogpricing



1-contact connector

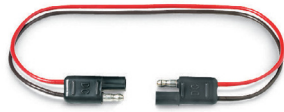

2-contact flat connector

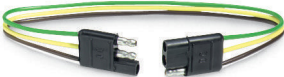

3-contact flat connector

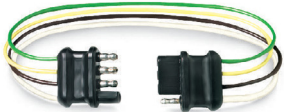

4-contact flat connector



5-contact square connector



5-contact flat connector



6-contact square connector



8-contact square connector

Molded Connectors with a Loop

Molded trailer connectors are manufactured with a loop of 16 gauge copper primary wire between a male and female end, except 8-contact which are manufactured with 3-12 gauge and 5-16 gauge copper wires. Four-contact, flat connectors are molded with an Easy Grip® for fast and easy disconnects. Loop may be cut to desired length for splicing into a wiring assembly.

SPECIAL NOTE

If our catalog does not have the correct wire color or gauge size needed for your application, a custom molded connector can be manufactured to your specification. Minimum order quantities will apply.

1-contact flat

part no.	description
74115	12" loop
74165	48" loop

5-contact square

part no.	description
74515	12" loop
74565	48" loop
74525	60" loop

2-contact flat

part no.	description
74215	12" loop
74265	48" loop
74225	60" loop

5-contact flat

part no.	description
74520	12" loop
74540	48" loop
74560	72" loop

3-contact flat

part no.	description
74315	12" loop
74365	48" loop
74325	60" loop

6-contact square

part no.	description
74615	12" loop
74665	48" loop
74625	60" loop

4-contact flat

part no.	description
74415	12" loop
74465	48" loop
74425	72" loop

8-contact square

part no.	description
74815	12" loop
74865	48" loop
74825	60" loop

Use With trailer adapters PAGE 222



contacts	male end	wire colors	female end
* for 5, 6, and 8-contact molded connector configurations, see page 186			
5 square		1. green 2. blue 3. yellow 4. brown 5. white	
5 flat		1. blue 2. green 3. yellow 4. brown 5. white	
6		1. yellow 2. brown 3. white 4. green 5. blue 6. black	
8		1. green 2. blue 3. gray 4. yellow 5. brown 6. black 7. red 8. white	

red, white, black wires = 12 gauge; green, blue, brown, yellow, gray = 16 gauge

trailer connectors



75010 (female)



75012 (male)
one-way housing



75018 (female)



75020 (male)
three-way housing



male terminal

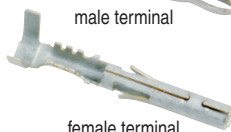

female terminal



cavity seals



cavity plug

Weather Pack Environmental Connectors

The Weather Pack environmental connectors are designed for the engine compartment of a vehicle. They are also ideal for use in marine, agriculture and other harsh environmental applications. Audible snap-action lock for housing and secondary terminal lock helps reduce terminal stress, provides proper terminal positioning and easy access for service. Stops in cavities to ensure proper insertion of terminals. Indexed nylon housings are rated -40°C to 125°C (-40°F to 257°F). Housing, terminals, plugs and seals are sold separately. Rated up to 20A at 12V DC.



Scan for pricing or go to www.delcity.net/catalogpricing

INFORMATION

Three basic environmental seal tests were performed which involved salt, fog, immersion and immersion flex. Between lab tests and millions of miles logged on current vehicles, these connectors have proven reliable and provide a fail-safe environmental connection.

description	tower (female)	shroud (male)
1-way housing	75010	75012
2-way housing	75014	75016
3-way housing	75018	75020
4-way flat housing	75022	75024
4-way square housing	75044	75046
6-way housing	75026	75028

Weather Pack Environmental Terminals

The flex-pin and lap-lock design gives these terminals a positive connection. Dual "tang" lock the terminal into the connector cavity. Cable seal crimp wings reduce strain on the cable core and assure proper positioning of the cable seal. Rated up to 20A at 12V DC.

description	tower (female)	shroud (male)
20-18 gauge terminal	75032	75030
16-14 gauge terminal	75036	75034
12 gauge terminal	75040	75038

Weather Pack Environmental Seals and Plugs

Self-lubricating, silicone seals have multiple "ribs" to guard against dust, moisture, engine compartment fluids and chemicals. Cavity seals are crimped to the terminal to assure positive position of the seal in the housing cavity. The cavity plug is designed to fill and seal unused cavities.

description	color	part no.
22-20 ga	purple	75000
20-18 ga	green	75002
16-14 ga	gray	75004
12 ga	blue	75006
20-18 ga	orange (mylar)	75008
cavity plug	green	75042

ASSEMBLY INSTRUCTIONS

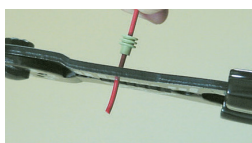

1. Insert seal onto cable before stripping insulation.

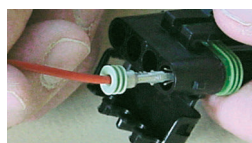

2. Crimp terminal onto stripped wire, seal and insert into connector housing.

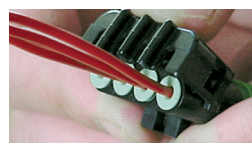

3. Once all terminals are inserted, lock wire and seal as shown above.

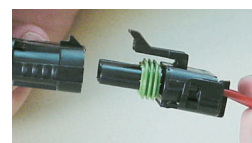

4. Male and female housings connect together until locked once steps 1, 2, and 3 are completed.



Scan for pricing or go to www.delcity.net/catalogpricing



906475



906485



906495



990174

Weather Pack Tools

Designed for the positive crimping of weather pack terminals. Quality tools for long-lasting and dependable service. The removal tool provides easy removal of terminals. Ratchet assembly assures a perfect crimp every time.

part no.	description	OEM #
906475	removal tool, 1/8"	12014012

part no.	description	gauge
990174	Weather Pack and Metri®-Pack 150 and 280 sealed crimper	22-14
906485	multi-gauge crimper	20-14
906495	crimper	12-14
908495	crimper	12



Weather Pack Kit – *microSERIES™*

An excellent starter kit for the weather pack system. Contains an assortment of male and female terminals, as well as seals and plugs. All contained within a durable, lightweight, translucent plastic carrying case (4 1/2" x 25 8" x 15 16").

For a complete listing of kit contents, see page 331.

part no.	description	pieces
75050	weather pack kit	425



Weather Pack Connector Kit

This kit contains everything you need to make a quality weather-resistant connection over and over again. A whopping assortment of 1,280 total pieces, including terminals, seals and housings. All contained within a rugged, gray metal scoop box (18" x 12" x 3").

For a complete listing of kit contents, see page 330.

part no.	description	pieces
75045	weather pack connector kit	1,280



Weather Pack Terminal & Seal Kit w/Tools

A 1,100 piece assortment of both male and female terminals, seals and plugs. Also included are 2 ratchet style crimping tools and 1 terminal removal tool. All contained within a rugged, gray metal scoop box (18" x 12" x 3"). **For a complete listing of kit contents, see page 330.**

part no.	description	pieces
75043	weather pack kit	1,103

Use With

4-drawer rack
PAGE 295

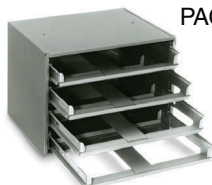

trailer connectors

Metri®-Pack Sealed 280 Series Connector Housings

Positive locking action ensures proper connection between housings. Made from heat stabilized, impact modified Polyamide 66 material. Tri-ribbed seal on female housing aids in resistance to harsh environments. Temperature rating: -40°C to 125°C (-40°F to 257°F). Rated up to 30A @ 12V DC.

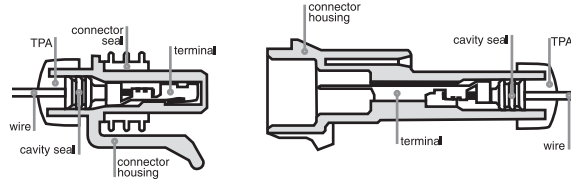

Scan for pricing or go to www.delcity.net/catalogpricing

description	female	male
1-way housing	85010	85012
2-way housing	85014	85016
3-way housing	85018DL	85020DL
4-way housing	85022	85024
5-way housing	85026	85028

Terminal Position Assurance – TPA

Firmly holds terminals in connector housings. Helps reduce tension between terminal and wire connection. Made from heat stabilized, impact modified Polyamide 66 material. Temperature rating: -40°C to 125°C (-40°F to 257°F).

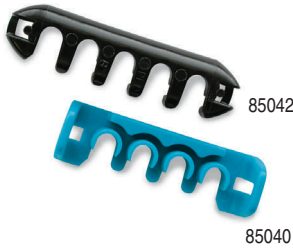

description	female	male
1-way TPA	85030	85030
2-way TPA	85032	85032
3-way TPA	85034	85036
4-way TPA	85038	85040
5-way TPA	85042	85044

Terminals

Terminals are push-to-seat. Singular “tang” locks terminal into housing, ensuring proper insertion. Tin-plated for added protection from corrosion. Rated up to 30A @ 12V DC.

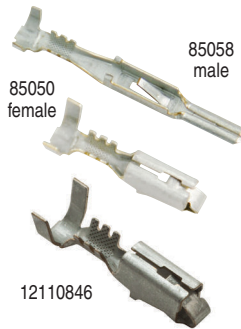

gauge (mm ²)	female	male
Tang		
22–20 (.50–.35)	85052	85060
18–16 (1.0–.80)	85050DL	85058
14–12 (3.0–2.0)	85048DL	85056
10 (5.0)	85046DL	85054
Tangless		
22–20 (.50–.35)	12110846	-
18–16 (1.0–.80)	12110847	-
16–14 (.80–3.0)	12129409	-
14–12 (3.0–2.0)	12110845	-

Cavity Seals & Plugs

Self-lubricating, silicone seals have multiple “ribs” to guard against dust, moisture, engine compartment fluids and chemicals. Cavity seals are crimped to the terminal to assure positive position of the seal in the housing cavity. The cavity plug is designed to fill and seal unused cavities.



description	color	part no.
22–20 ga	purple	75000
20–18 ga	green	75002
16–14 ga	gray	75004
12 ga	blue	75006
20–18 ga	orange (mylar)	75008
cavity plug	green	75042



Scan for pricing or go to www.delcity.net/catalogpricing



Metri®-Pack 280 Tangless Terminal and Seal Kit

The Metri-Pack™ 280 tangless kit provides all the essential Metri-Pack™ 280 tangless female terminals, seals and cavity plugs. This small kit ensures you have the inventory and is ideal for small projects. Components come in a convenient carrying case (4-1/2"x2-5/8"x1-5/16").

For a complete listing of kit contents, see page 331.

part no.	description	pieces
75052	Metri-Pack™ 280 Tangless Terminal and Seal Kit	425



Metri®-Pack 280 Sealed Terminal and Seal Kit

The Metri-Pack™ 280 kit provides all the essential Metri-Pack™ 280 female terminals, seals and cavity plugs. This small kit ensures you have the inventory and is ideal for small projects. Components come in a convenient carrying case (4-1/2"x2-5/8"x1-5/16").

For a complete listing of kit contents, see page 331.

part no.	description	pieces
75053	Metri-Pack™ 280 Sealed Terminal and Seal Kit	425



908475



908485



908495



990174

Metri®-Pack Tools

Designed for the positive crimping of Metri-Pack™ terminals. Quality tools for long-lasting and dependable service. Removal tool provides for easy removal of terminals. Ratchet assembly ensures a perfect crimp every time.

part no.	description	gauge	OEM #
908475	removal tool	—	12094429
908485	multi-gauge crimper	20–14	12155975
908495	crimper	12–10	12071687
990174	Weather Pack and Metri®-Pack 150 and 280 sealed crimper	22-14	-

2–6 Brake Controller Timed Electric

This brake controller works with any trailer with 2 to 6 electric brakes (1–3 axles). The time based electric control features an LED indicator that brightens as it applies force to the trailer brakes. A manual brake control lever and adjustable thumb wheel allow for output control. The solid state circuitry eliminates the need for unit to be leveled. Mounting hardware and instructions are included.



part no.	description
63001	2–6 brake controller, timed electric, LED display

2–8 Brake Controller Timed Electric – Digital

This brake controller works with any trailer with 2 to 8 electric brakes (1–4 axles). The time based electric control features an LED indicator that brightens as it applies force to the trailer brakes. A manual brake control lever and adjustable thumb wheel allow for output control. The solid state circuitry eliminates the need for unit to be leveled. Also incorporated is a self diagnostic system that continually monitors trailer connection and checks for short circuits. Mounting hardware and instructions are included.



part no.	description
63003	2–8 brake controller, timed electric, LED display

trailer connectors

2-8 Brake, Dual Axis Accelerometer



This brake controller controls any trailer with 2-8 electric brakes (1-4 axles). It uses an advanced accelerometer mechanism to sense when the vehicle is slowing and responds with the appropriate brake pressure to provide a seamless stop. Mounts in a variety of angles above or below the dash and is self-leveling – no setup required. Digital display provides brake-force details, and self diagnostic. Continually monitors trailer connection and checks for short circuits. Simple push-button calibration with manual brake control lever and adjustable thumb wheel output control. Compatible with electric over hydraulic systems and with electronic systems (anti-lock brakes and cruise control). Mounting hardware and instructions are included.



Scan for pricing or go to www.delcity.net/catalogpricing

part no.	description
63005	2-8 brake controller, dual axis accelerometer



63014

Wire Harnesses

Mates your brake controller directly to your OEM's wire harness with no cutting or splicing. OEM harness includes dual mating connectors; wires are encased in slit loom.



63018

part no.	description
63012	GM/Chevy 2002-1999
63014	Ford 2009-1994
63016	Dodge 2009-1996
63018	universal wire harness

Breakaway Kit

Includes battery, battery charger, case, breakaway switch with pin and cable and mounting hardware. Easily installs on tongue or trailer frame. Rechargeable 12V, 5 amp/hr battery. Rugged, lockable case holds battery and charger. Recommended for use on all trailers with 2, 4 or 6 electric brakes.



part no.	description
63002	breakaway kit

Breakaway Switch

48" covered steel cable with loop. 48" wire leads that connect to the breakaway battery unit. Durable plastic housing mounted to steel bracket with a .250" mounting hole for easy single screw installation. For use with electric trailer brake systems.



74993

part no.	description
63000	breakaway switch



74991

Trailer/Tail Light Converters

These converters are electronic devices that convert your vehicle's stop/tail/turn signal outputs into the needed trailer signals. They are ideal for cars and trucks with separate bulbs for stop and turn signal operations, but need to operate trailers that utilize the same bulb for both operations. Rated up to 3 amps and for 12V DC systems.



74995

part no.	description
74991	car side light converter, 18"; 3 to 2
74995	trailer side light converter, 60"; 4 to 5
74993	car side light converter, 12"; 5 to 4 w/plug end





Scan for pricing or go to www.delcity.net/catalogpricing



Trailer Connector Adapters

Innovative one-piece molded design adapts 7, 6 or 4-way trailer connectors. Manufactured to interchange with standard trailer and molded connectors. Manufactured from nylon material for corrosion resistance. Socket material and molded connector wire lengths may vary, but function remains the same.



part no.	description	converts socket	converts plug
73010DL	6-way round pin to 4 flat molded conn	73635	74475
73011	7-way round pin to 4 flat molded conn	73735	74475
73012	7-way mobile home/RV to 4 flat molded conn	73675	74475
73013	7-way mobile home/RV to 6-way round pin	73675	73625
73014	4-way round to 4 flat molded conn	71565	74475
73016	7-way mobile home/RV to 5 flat molded conn	73675	74505



Protective Covers

Protective cover for both male and female 4-way flat molded connectors.

part no.	description
73090	protective covers

Use With

molded connectors
PAGE 215-216



Trailer Connector Tester

LED trailer connector tester confirms and analyzes tail light, turn signal and ground connections from your vehicle.

part no.	description
73095	4-way trailer connector tester
73097	7-way flat trailer connector tester



Knockout Connectors

The patented knockout connector eliminates the unsightly and corrosive effect of conventional plugs hanging loose below the bumper. Four-way female molded trailer connector with a weather-proof dust cover, mates with most 4-way conventional male plugs on the market. Molded with 30" of 16 gauge wire, it's long enough to reach either side of the towing vehicle to tap into the trailer lights. The wires are color-coded: green, yellow, brown and white.

"the knockout"



As shown, "the knockout" is designed to snap into pre-existing 1.250" hole on either side of the bumper

part no.	description
74405	knockout molded connector

trailer connectors

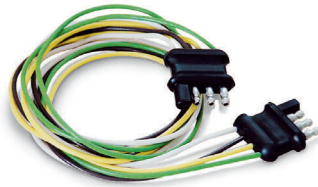

'Kwik Connect' Jumper

36" loop of 16 gauge wire, with 4-way male connectors on each end for connecting 'knockout' connector on trailer to 'knockout' on car end. Makes a fast and easy connect.

part no.	description
74045	'kwik connect' jumper



Scan for pricing or go to www.delcity.net/catalogpricing



plug



socket

Small Trailer Connectors

These 2 and 4-contact, 20 amp connectors feature polarized contacts and screw connections protected by rubber boots. Length 2-11/16". 6-24 volt applications. Plug and socket supplied as a complete unit.

part no.	description
71215	2 contact, complete unit
71415	4 contact, complete unit



9000

7-contact Round Pin Coiled Trailer Cable

These coiled cables are designed to withstand the toughest environments for the heavy-duty tractor/trailer industry. The patented Xenoy® plugs are virtually destruction and corrosion proof with a temperature rating of -56°C to 204°C (-70°F to 400°F). They are also lightweight and have a locking grit that will not disengage from a pull force of up to 480 lbs. The wire jacket resists chemicals, cutting, abrasion, gasoline, ozone, water, solvents, sunlight and is designed with a sag-proof memory coil.

part no.	description	gauge/conductor
9000	green ABS coiled cable, 12'	4-12 ga, 2-10 ga, 1-8 ga
9005	green ABS coiled cable, 15'	4-12 ga, 2-10 ga, 1-8 ga
9010	black jacket coiled cable, 12'	6-12 ga, 1-10 ga
9015	black jacket coiled cable, 15'	6-12 ga, 1-10 ga



73735



73725

7-contact Metal Truck/Trailer Connectors

The cadmium plated socket and plug, are manufactured from heavy gauge, drawn steel. They are interchangeable with most brands and feature a polarizing, round, brass contact. Socket cover locks the plug into place when in use and remains closed when unused to keep out moisture and debris. Mounting is 2 1/16" center-to-center. Rated to 40A @ 6-28V DC.



73745

part no.	description
73725	plug
73735	socket
73745	protector spring
73685	connector boot; fits 73735



73685



73740



73731

7-contact Nylon Truck/Trailer Connectors

The socket and plug are manufactured from nylon material to help eliminate corrosion, rust and poor appearance. Socket cover locks the plug into place when in use, and remains closed when unused to keep out moisture and debris. Mounting is 2-15/16" center-to-center. Rated to 40A @ 6-28V DC.

part no.	description
73731	nylon plug
73740	nylon socket, solid pin

7-contact Metal Mobile Home/RV Connectors

The flat pin, socket and plug are both manufactured from steel material to provide strength and durability. The socket's locking latch ensures a positive connection and prevents accidental plug disengagement. Socket and plug wire connections are labeled with industry standard markings. 70975 is a rust-proof bracket for mounting 73675 socket. Rated to 20A @ 12V DC.



part no.	description
73665	plug
73675	socket
70975	mounting bracket

7-contact Nylon Mobile Home/RV Connectors

The flat pin, socket and plug are both manufactured from nylon material to help eliminate corrosion, rust and overall poor appearance. The socket's locking latch ensures a positive connection and prevents accidental plug disengagement. Socket and plug wire connections are labeled with industry standard markings. 70955 is zinc-plated with a e-coating finish, for mounting with socket 73771. Rated to 20A @ 12V DC.



part no.	description
73770	nylon plug
73771	nylon socket
70955	mounting bracket

CURT™ Multi-function Sockets w/Back-up Alarms

Replace existing RV style sockets with these multi-function sockets. Each accepts standard RV style plugs, but also incorporates a four-way molded plug, eliminating the need for the easy-to-lose adapters. For added safety, a back-up alarm is manufactured into the design to alert others when vehicle is in reverse.



part no.	description	vehicle
CURT57100	7-way RV socket w/4-way molded plug	Dodge
CURT57101	7-way RV socket w/4-way molded plug	GM/Ford
CURT57102	7-way RV socket w/4-way molded plug	Universal

OEM Style RV Socket and Harness Kit

Kit includes socket, 4-ft harness with connector and mounting bracket. The 7-wire leads are color-coded to RVI standards for ease of installation. Assembly is corrosion resistant, featuring tin-plated copper alloy terminals and silicone at the rear of the socket to complete a sealed connection. Fits many popular OEM truck applications.



part no.	description
73750	OEM style RV socket and harness kit



Scan for pricing or go to www.delcity.net/catalogpricing

trailer connectors

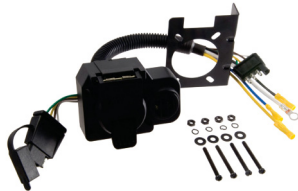

CURT™ OEM Replacement Harnesses

Replace existing worn-out harnesses or sockets. Each is manufactured from nylon material for durability and directly works with existing wiring.

part no.	description
CURT57100	7-way RV socket w/4-way molded plug
CURT57101	7-way RV socket w/4-way molded plug
CURT57102	7-way RV socket w/4-way molded plug
CURT55384	harness adds 4-way flat molded connectors
CURT56574	harness adds 5-way flat molded connectors
CURT55515	OEM replacement 4-way flat
CURT56515	OEM replacement 5-way flat
CURT55664	OEM connector, gives 6-way & 4-way multi socket
CURT55774	OEM connector, gives 7-way & 4-way multi socket
CURT55415	US car replacement socket for 7-way OEM Ford, GM & Nissan
CURT57101	7-way RV socket w/4-way molded plug



Scan for pricing or go to www.delcity.net/catalogpricing

6-contact Metal Connectors

The socket and plug are manufactured from die cast metal for optimal performance. The socket's positive locking latch ensures proper insertion and prevents plugs accidental pull out. The split-pin design is interchangeable with competitive brands. Mounting hole is 2-15/16" center-to-center. 70965 is a rust-resistant bracket for 73635. Rated to 35A @ 12V DC.



part no.	description
73625	plug
73635	socket
70965	mounting bracket

6-contact Concealed Terminal Metal Trailer Connector

This socket is manufactured from heavy gauge, drawn steel for optimal performance and durability. The extended barrel provides added strain relief for the wire hook-up that accepts up to 10 gauge wire. Split pin terminals mate up with competitive plugs. Rated to 35A @ 12V DC.

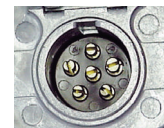

part no.	description
73730	concealed terminal socket

6-contact Plastic Connectors

The trailer connectors are an economical trailer connection pair. The plug has a matte finish and the socket is manufactured from a black plastic material for corrosion resistance. Socket also incorporates a rubberized boot to help provide additional weather resistance and wire strain relief. Designed for recreational vehicles. Mounting holes are 2-15/16" center-to-center. Rated to 35A @ 12V DC.



part no.	description
73765	plug
73775	socket
73695	protective boot; fits 73775
70965	mounting bracket

4-contact Round Trailer Connectors

The socket and plug are manufactured from die cast metal for optimal performance. The socket's positive locking latch ensures proper insertion and prevents plugs accidental pull out. The socket features a split-pin design and mounts through a 1.375" diameter hole. Mounting bolt holes are 2.875" center-to-center. Rated to 35A @ 12-24V DC.



part no.	description
71545	plug
71565	socket



Scan for pricing or go to www.delcity.net/catalogpricing



71595



71575



70965

4-contact Chrome Metal Connectors

The socket and plug are manufactured from chrome plated zinc die cast metal for optimal performance. The socket mounts through a .960" diameter hole and the mounting bolt holes are 1.813" center-to-center. Rated to 20A @ 12V DC.

part no.	description
71575	plug
71595	socket
70965	mounting bracket



71571



71570

Single-contact Trailer Connectors

Ideal for almost all heavy-duty power applications. Provides power from battery to auxiliary equipment. Interchangeable with competitive brands. Rated for 300A continuous duty. Pin accepts up to 2/0 cable (solder connection) and grounding lug is 4-2 gauge cable. Use 73745 protector spring (pg. 235) for strain relief on 71570.

part no.	description
71570	plug
71571	socket



73440



73442

Locking Trolling Motor Plug & Receptacle

Locking plug and receptacle provides a superior electrical connection for trolling motors. Plug "locks" into receptacle and provides a waterproof seal; screw terminals will not loosen under extreme hull vibration and drain holes in receptacle keep water away from electrical components. Universal design for 2 or 3-wire configuration: 12, 24, 12/24, 24/36 or 36 volt systems. Corrosion resistant, plated brass electrical components; standard 1.125" diameter mounting hole. Easy to install, with supplied mounting plate for front panel installation, or locking ring for rear access installation. Easily replaces other plugs and receptacles. Receptacle accepts 10 to 8 gauge wire; plug accepts 16 to 8 gauge wire.

part no.	description
73442	locking trolling motor plug
73440	locking trolling motor receptacle



73540



73542

Deluxe 12 Volt Plug & Receptacle

Plug "locks" into receptacle and provides a waterproof seal. Easy to install, with supplied mounting plate for front panel installation, or locking ring for rear access installation. Watertight sealing cap on the receptacle; moisture proof sealing ring on the plug. Compatible with standard 12V plug and receptacles. Plug has an internal strain relief and cord seal, with an interchangeable 10A fuse.

part no.	description
73540	locking 12V plug
73542	locking 12V receptacle



Auxiliary 12 Volt Lighter Socket

Lighter plug with protective snap-on cover. Standard .250" push-on terminals for wire connection. 1.10" mounting hole.

part no.	description
73549	auxiliary 12V lighter socket



Snap-in Female Lighter Socket

Lighter plug with protective snap-on cover. Fast mounting expandable clips. Under dash mounting bracket included.

part no.	description
73548	snap-in female lighter socket

LED LIGHTS

Longer Life LED lamps have up to a 100,000 hour rated life, which results in lower long-term costs. While traditional incandescent lamps last 1–2 years before replacement is needed, LED lamps can have a life expectancy of up to 20 years.

Brighter Illumination LED lamps are brighter and illuminate faster with a lower current draw. Incandescent bulbs can lose up to 90% of their energy in light blocked by colored lenses; LEDs deliver 100% of their energy as colored light.

Greater Durability LED lamps are shock and vibration resistant. Most circuits are epoxy resin coated to resist moisture and corrosion. For added assurance, polycarbonate lenses and housings are sonically sealed (excluding 7650 & 7655).



Scan for
pricing
or go to
[www.delcity.net/
catalogpricing](http://www.delcity.net/catalogpricing)



LED 4" Stop, Tail, Turn Lamps

Easily retrofit your existing trailer lamps with these LED lamps. They are manufactured with a high impact, polycarbonate lens and housing. These lights have completely sealed electronics. Each light features 9 LEDs that have an extremely low amp draw of 140 ma. Use a standard 4" grommet (8810) and male pigtailed (8705, 8710) for wire connections. Rated at 12.8V DC. SAE J1395, J1398, J585e.

part no.	description
7400	LED, 4.25" red, 9 diode
7405	LED, 4.25" amber, 9 diode



LED 4" Steel Case Stop, Tail, Turn Lamp

These 4" steel case LED stop, tail and turn lights easily retrofit existing trailer lights and truck lights. The steel case helps to protect the light and wire components as well as provide theft resistance. These lights feature sealed moisture proof electronics, polycarbonate lens and housing and a nickel plated brass connector. The 9 LED's are rated to 12.8V DC, 140ma. DOT/SAE J1395, J1398, J585e rated.

part no.	description
7410	LED, 4.25" red, 9 diode



LED 4" Stop, Tail, Turn Lamps



These high count LED lamps are manufactured with a high impact polycarbonate lens sonically sealed onto housing. The 5mm LEDs provide a superior illumination that can last up to 100,000 hours. The female receptacles are grease filled to help reduce corrosion at the connection point. Use a standard 4" grommet (8810) and male pigtailed (8705, 8710) for wire connections. SAE J1395, J1398, J585e. Rated to 12.8VDC, 340 ma.

part no.	description
7500	LED, 4.25" red, 44 diode
7505	LED, 4.25" amber, 48 diode



LED 4" Stop, Tail, Turn Lamp 12/24V DC



This lamp is designed specifically for Fleet and OEM stop/turn/tail applications. Both housing and lens are manufactured from poly-carbonate material and features nine, LEDs in a flat-back, slim profile. This lamp provides superior illumination and can last up to 100,000 hours. Use standard 4" grommet (8810) and male pigtailed (8705, 8710) for wire connections. Rated to 12VDC at 140ma or 24VDC at 80ma. SAE J1395, J1398, J585e.

part no.	description
7300	LED, 4.25" red, 9 diode



Scan for pricing or go to www.delcity.net/catalogpricing



7420



7415



7510

LED Oval Stop, Tail, Turn Lamps

This oval, 9 diode LED stop, tail and turn light is constructed for superior longevity, allowing up to 100,000 hours of illumination. These lights are designed to easily retrofit existing lights in automotive and trailer applications. These lights feature sealed moisture proof electronics, plated brass connectors and polycarbonate housing and lens. Use standard grommet (8815) and male pigtailed (8705 & 8710) for mounting and connecting. This lamp is rated for 12.8VDC and draws 190 ma. SAE J1395, J1398, J585e and DOT rated.

part no.	description
7415	LED, oval red, 9 diode
7420	LED, oval amber, 9 diode

LED Oval Stop, Tail, Turn Lamps



These high count LED lamps are manufactured with a high impact polycarbonate lens sonically sealed onto housing. The 5mm LEDs provide a superior illumination that can last up to 100,000 hours (11 years). The female receptacles are grease filled and electronics are completely sealed in epoxy to help reduce corrosion and vibration. Use a standard oval grommet (8815) and male pigtailed (8705, 8710) for wire connections. They meet SAE and DOT ratings J1395, J13998, J585e. Rated to 12.8V DC.

part no.	description
7510	LED, oval red, 60 diode
7515	LED, oval amber, 60 diode



LED Oval Stop, Tail, Turn Lamp 12/24V DC



This lamp is designed specifically for Fleet and OEM stop/turn/tail applications. Both housing and lens are manufactured from poly-carbonate material and features nine LEDs in a flat-back, slim profile. This lamp provides superior illumination and can last up to 100,000 hours. Use standard oval grommet (8815) and male pigtailed (8705, 8710) for wire connections. Rated to 12V DC at 140 ma, or 24V DC at 80 ma. Meet SAE J1395, J1398, J585e.

part no.	description
7315	LED, oval red, 9 diode



7930

LED Rectangle Stop, Tail, Turn Lamps



These high count LED lamps are manufactured with a high impact polycarbonate lens sonically sealed onto housing. They can be used as a marker lamp or rear tail lamp. The 5mm LEDs provide a superior illumination that can last up to 100,000 hours (11 years). The female receptacles are grease filled and electronics are completely sealed in epoxy to help reduce corrosion and vibration. Use a standard rectangle grommet (8820) and male pigtailed (8705, 8710) for wire connections. SAE rated J845. Rated to 12.8V DC at 280ma.

part no.	description
7930	LED, rectangle red, 52 diode



7603



7600



7604

LED 3/4" Sealed Clearance Marker Lamps



The mini combination clearance marker lamps are designed to fit into the smallest places and can be used as clearance marker lamps. They feature 3 SMD LEDs enclosed in a sealed acrylic housing. The 6" jacketed wire leads and rubber grommet provide added abrasion resistance and shock protection. Snap mounting into a 3/4" hole. They meet SAE DOT P2PC standard and are rated to 12.8V DC. Connector: 2 male .180" bullets.

part no.	description
7600	LED, 3/4" round red, 3 diode
7604	LED, 3/4" round green, 3 diode
7605	LED, 3/4" round amber, 3 diode
7601	LED, 3/4" round white-clear lens, 3 diode
7603	LED, 3/4" round blue-clear lens, 3 diode
7610	LED, 3/4" round red-clear lens, 3 diode
7615	LED, 3/4" round amber-clear lens, 3 diode

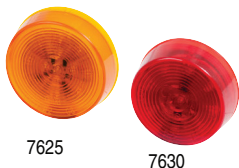

LED 2" & 2-1/2" Sealed Clearance Marker Lamps

LED side marker lights provide up to 100,000 hours of illumination and provide a dependable solution to reduce costly down-time. Side marker lights are ideal for any truck, trailer for other application that requires vehicle length identification. These lights feature a hermetic lens-to-housing seal and twist-on mounting for easy installation. These lights will fit all popular mountings and grommets. These lights are rated for 12V applications, 0.15A (2.5") or 0.09A (2").

part no.	description
7620	LED, 2½" red, 3 diode
7625	LED, 2½" amber, 3 diode
7630	LED, 2" red, 3 diode
7635	LED, 2" amber, 3 diode



Scan for pricing or go to www.delcity.net/catalogpricing



LED Rectangle Clearance Marker Lamps



Rectangular LED clearance marker lights provide an aesthetically pleasing and secure solution for vehicle applications. These LED marker lights are a popular choice found on semi trucks and can also be used to upgrade current cab marker lights. These lights feature a stainless steel bezel, polycarbonate lens and housing, and a solid state circuit board. The light's 12 LED's are rated to 12.8V DC, 60ma. SAE/DOT J592e rated.

part no.	description
7430	LED, rectangle red, 2 diode
7435	LED, rectangle amber, 2 diode



LED Chrome, Flush Mount Clearance Marker Lamps



These LED lamps have the high impact polycarbonate lens sonically sealed to the housing to keep out moisture and other debris. The up to 100,000 hours (11 years) lamps help reduce costly down-time due to lamp failure. They are ideal for lower body marking. Use standard pigtail (8700, 8701). DOT, SAE and P2 rated. Rated to 8-14V DC.

part no.	description
7690	LED, oval red, 5 diode
7695	LED, oval amber, 5 diode

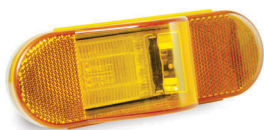

LED Oval Sealed Side Marker and Turn Signal Lamp



This lamp is designed specifically for Fleet and OEM stop/turn/tail applications. Both housing and lens are manufactured from poly-carbonate material and features 28 LEDs. It meets SAE J2039 and J592 specifications. This lamp provides superior illumination and can last up to 100,000 hours. Use standard oval grommet (8815) and male pigtails (8700, 8701) for wire connections. Rate to 12.8V DC 370 ma.

part no.	description
7565	LED, oval amber



LED Scalloped Clearance Marker Lamps

Scalloped LED clearance marker lights are available in red or amber. Ideal for a variety of vehicles, scalloped LED marker lights are self-grounding and come with 75 inches of lead wire for easy installation. These light feature a molded snap-ring, an encapsulated potting for total circuit board protection and a field-replacement lens. These lights are rated for 12V applications. 0.15A.

part no.	description
7650	LED, scalloped red, 10 diode
7655	LED, scalloped amber, 10 diode



Scan for pricing or go to www.delcity.net/catalogpricing



LED Thin-line Sealed Clearance Marker Lamps

Low profile LED clearance marker lights can be used as side markers for utility vehicles, semis and trailers. The thin-line sealed clearance markers are available in red or amber and feature 12 LED diodes for bright illumination up to 100,000 hours. These 3.8" rectangular marker lights plug into existing mounting bases, feature a polycarbonate lens and housing and have completely sealed electronics. These lights are rated to 12.8V DC, 50ma. DOT/SAE J592e rated.

part no.	description
7640	LED, thin-line red
7645	LED, thin-line amber

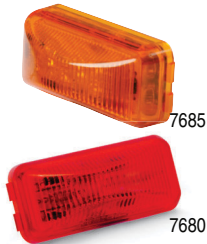

LED Mini Clearance Marker Lamps

These 2-1/2" rectangular clearance markers can be used as side markers for utility vehicles, semis and trailers. These clearance markers are available in red or amber and feature 8 LED diodes. These clearance markers can plug into existing mounting bases, feature a polycarbonate lens and housing and have sealed moisture proof electronics. These lights are rated to 12.8V DC, 40ma. DOT/SAE J592e rated.

part no.	description
7680	LED, mini red
7685	LED, mini amber



LED Round Sealed Work Lamp

This heavy-duty lamp is designed to endure the roughest terrains. It is manufactured with a powder-coated aluminum housing and polycarbonate lens. The 6 powerful LEDs provide a total of 550 lumens, with a minimal 5A draw. Mounting: 5/16" diameter bolt.

part no.	description
7995	LED, crystal, 6 diode



LED Oval Crystal Lamp

This low count LED lamp has a lens that is manufactured from high impact, polycarbonate that is sonically sealed to the housing. It provides superior illumination that can last up to 100,000 hours (11 years). The female receptacles are grease filled and have potted internal connections for superior longevity. Use a standard oval grommet (8815) and male pigtailed (8705, 8710, 8715 or 8720) for wire connections. Rated to 8-14V DC.

part no.	description
7513	LED, oval crystal, 10 diode



LED Rectangle License Plate Lamp

This LED lamp features a chrome-plated brass bezel to cover the polycarbonate lens that is sonically sealed to the body. The LEDs provide superior illumination and can last up to 100,000 hours (11 years). The hard wired connections are sealed in epoxy for added weather resistance and shock absorption. Mounts 2" center-to-center. DOT and SAE rated. Rated to 8-14V DC.

part no.	description
7865	LED, license plate, 2 diode



3M Scotchlite™ Reflective Tape

Red/white conspicuity tape is designed to mark the side and rear perimeter of trucks and trailers for enhanced visibility and detection. 100% plastic, non-corrosive and edge sealed. Item no. 740 alternates 11" red and 7" white; 750 alternates 6" red and 6" white (ideal to sell by the foot, one red and one white = 1'). After each red and white segment, tape is cut. Provided on a continuous backing. Certified to meet the NHTSA standards.

part no.	description	size
740DL	red/white reflective tape	bulk roll- 2" x 150' (alternates 11" red, 7" white)
750	red/white reflective tape	bulk roll- 2" x 150' (alternates 6" red, 6" white)

INCANDESCENT LIGHTS

Several styles of DOT-certified truck and trailer lamps, lamp accessories, reflectors and replacement mirrors are offered. These products are heavily used in the trucking industry, but can be used by construction equipment and farm implement original equipment manufacturers.

Resistant to shock, vibration, heat, moisture and corrosion, these lighting products provide a lifetime of trouble-free performance.



Scan for
pricing
or go to
[www.delcity.net/
catalogpricing](http://www.delcity.net/catalogpricing)



8500

8505

4" Round Stop, Tail, Turn Lamps

These aftermarket round, 4" tail, brake and turn lights feature a rugged, safe construction that is able to absorb vibration and road shock. These lights provide a cost effective retrofit for current lighting on a car, truck or trailer. These lights feature a standard female connection and are able to fit all competitive pigtails, brackets and grommets. The lamps include a hermetic lens-to-housing seal. Rated for 12V applications, 2.1A.

part no.	description
8500	red, 4" incandescent lamp
8505	amber, 4" incandescent lamp



4" Round Steel Case Stop, Tail, Turn Lamp

These 4" steel case lights are ideal aftermarket truck tail lights as they easily retrofit existing lights on a truck or trailer. The steel case helps to protect the light and wire components as well as provide theft resistance. These lights feature rugged steel construction and an easy snap-on lens. These lights are rated for 12V applications, 2.1A.

part no.	description
8510	red, 4" incandescent lamp



7900



7905

Oval Stop, Tail, Turn Lamps

The oval shaped tail, brake and turn lights are ideal for aftermarket car tail lights and can also be used as a third brake light in vehicle applications such as cars and trucks. These lights feature a female pin connection and are rated for 12V applications. Amp rating is 2.1.



Use With
grommets
PAGE 235



part no.	description
7900	red, oval incandescent lamp
7905	amber, oval incandescent lamp



Universal 3-stud Mount Stop, Tail, Turn, Backup Lamp

This incandescent lamp features a high impact, polycarbonate housing and an acrylic lens attached to the housing with four screws for easy bulb replacement. Lens is dual stop, tail, turn signals with an additional window that allows for a back-up signal illumination. Lamps feature a steel reinforced 3-stud triangle, mounting pad with hardware and are pre-wired for easy installation. Lamps also contain one each replaceable #1157 and #1156 bulbs and are rated for 8 to 14V DC.

part no.	description
7925	red, 3-stud mount incandescent lamp



Scan for pricing or go to www.delcity.net/catalogpricing



8530

8525

2-1/2" Sealed Clearance Marker Lamps

Round clearance marker lamps provide a dependable solution to reduce costly down-time. Ideal for any truck, trailer or other application that requires vehicle length identification. Lamps include a hermetic lens-to-housing seal and over 12,000 hours of bulb life. These clearance markers have twist-on mounting for easy installation. Approved for 12V applications with a .33A rating.

part no.	description
8525	red, 2 1/2" incandescent lamp
8530	amber, 2 1/2" incandescent lamp



8535

2" Sealed Clearance Marker Lamps

These incandescent lamps feature a hermetically sealed polycarbonate lens and housing resistant to moisture, vibration and road shock. They are constructed to fit all popular standard grommet (8800, 8805) and bracket mounting systems. Lights are comparable to competitive brands and have a greased filled terminal port that accepts the standard 2-contact male pigtail connectors (8700, 8701). Lamp within is comparable to a #194 bulb and is rated for 8-14V DC. **For specific dimensions, see drawings on page 264.**

part no.	description
8535	amber, 2" incandescent lamp
8540	red, 2" incandescent lamp



7805

Oval Sealed Side Marker & Turn Signal Lamps

These incandescent lamps feature a hermetically sealed polycarbonate lens and housing resistant to moisture, vibration and road shock, and are designed to be mounted to the mid-trailer as a turn signal. The lens has a bubble flare that allows it to be visible from both the side and rear. Lamps are comparable to competitive brands and flush mount with a grommet (8815). Each lamp accepts the standard 3-contact male pigtail connectors (8705 & 8710) and has a greased filled terminal port. Lamp within is comparable to a #1157 bulb and is DOT and SAE AEP2 rated for 12V DC, 2.1A draw.

part no.	description
7805	amber, oval incandescent lamp



8545

2 Bulb Clearance Marker Lamps — Scalloped

These incandescent lamps are manufactured with a scalloped-style acrylic lens that snap-seals onto the plastic housing. Each is flush mount and pre-wired for fast and easy installation. Lamps within are comparable to a #193 bulb. SAE and DOT rated for 8-14V DC.

part no.	description
8545	amber, 2 bulb scalloped incandescent lamp
8550	red, 2 bulb scalloped incandescent lamp



8555



8560

2 Bulb Clearance Marker Lamps — Oval

These incandescent lamps are manufactured with an acrylic lens that snap-seals onto the plastic housing. Each is flush mount and pre-wired for fast and easy installation. Lamps within are comparable to a #193 bulb. SAE and DOT rated for 8-14V DC.

part no.	description
8555	amber, 2 bulb oval incandescent lamp
8560	red, 2 bulb oval incandescent lamp



7965



7960

1 Bulb Clearance Marker Lamps — Oval

These incandescent lamps are manufactured with an acrylic lens that snap-seals onto the plastic housing. Each is flush mount and pre-wired for fast and easy installation. Lamp within is comparable to a #193 bulb. SAE and DOT rated for 8-14V DC.

part no.	description
7960	red, 1 bulb oval incandescent lamp
7965	amber, 1 bulb oval incandescent lamp



Clearance Marker Lamps – Steel Armored

These steel armored clearance marker lights have a steel housing that completely protects the marker light. The protection that these lights provide make them ideal for mounting on the sides of trucks or trailers where lights are usually damaged. These lights feature two or four mounting holes for easy retrofits and a seal-tight expanded rubber gasket. There is no need for a lamp socket hole with this flat back design. Meets PC function when mounting at a 45 degree angle. Approved for 12V applications with a .33A rating.

part no.	description
8575	red, steel armored incandescent lamp
8580	amber, steel armored incandescent lamp



Scan for
pricing
or go to
[www.delcity.net/
catalogpricing](http://www.delcity.net/catalogpricing)



Clearance Marker Lamps – Bar Style

Three incandescent marker lamps are mounted 6" on-center onto a mounting bracket to create each of these light bars. Lamps are wired together and are ideal for mounting on the rear of trailers to indicate the presence of a wide vehicle. The 7850 has two .625" clearance holes and the 7855 has two .198" clearance holes for mounting. Bars are DOT and SAE P2, P3 rated for 12V DC.

part no.	description
7850	red, 2 $\frac{1}{2}$ " round incandescent bar marker lamp
7855	red, narrow rectangle incandescent bar marker lamp



Trailer Light Kit

This kit contains everything needed for a quick trailer lamp replacement job. Kits include two stop, tail, turn lamps, two clearance marker lamps, a license plate mounting bracket and a 30' trailer harness with miscellaneous wiring hardware. Each kit is DOT rated for 12V DC and is packaged in a clear plastic clam.

part no.	description
8025	trailer light kit

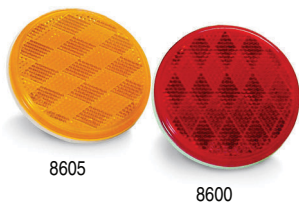

3" Stick-on Round Reflectors

Adhesive backing effortlessly mounts to any flat surface for permanent usage.

part no.	description
8600	red reflector
8605	amber reflector

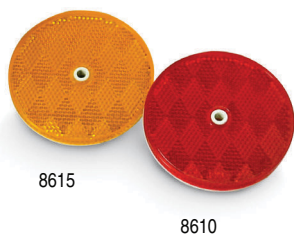

3-3/16" Center Mount Reflectors

Hermetically sealed center mount reflector. Mounts quickly with a #10 screw (not included).

part no.	description
8610	red reflector, 3- $\frac{3}{16}$ "
8615	amber reflector, 3- $\frac{3}{16}$ "

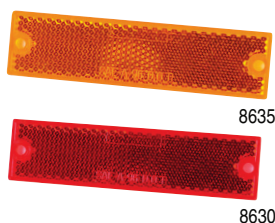

4-3/8" Stick-on Rectangle Reflectors

Versatile mounting options let you apply these 4-3/8" reflectors either with the adhesive backing or with the .173" clearance mounting holes spaced 3.93" center-to-center.

part no.	description
8630	red reflector
8635	amber reflector



Scan for pricing or go to www.delcity.net/catalogpricing



Rectangle LED License Plate Lamp



The polycarbonate lens of this lamp is sealed to high impact housing. The super 2 LEDs provide a superior illumination to their incandescent counterparts with less draw on your electrical system. A chrome-plated, brass bezel is used to cover the lamp and mounts 2" center-to-center. The hard wired connections are sealed in epoxy for added weather resistance and shock absorption. Rated for 8–14 volts DC and up to 100,000 hours of life. SAE and DOT rated.

part no.	description
7865	LED, license plate lamp, 2 diode



Chrome License Plate Lamp

These incandescent lamps feature a chrome-plated plastic housing and metal base. Lamps are equipped with a crystal lens and are DOT and SAE rated for 8 to 14V DC.

part no.	description
7860	chrome license plate lamp



License/Utility Light

This incandescent license lamp mounts directly into a 1.250" mounting hole and has a gasket to provide a weather proof seal. The light utilizes a common ground and is pre-wired with a 21" wire lead and .250" male disconnect. Lamp within is comparable to a #89 bulb and is rated for 8–14V DC.

part no.	description
73460	license/utility light



License/Utility Light

These incandescent license lamps are designed to mount directly into a GM/GMC truck step bumper or any other surface. Lights utilize a common ground and are pre-wired with a 6" wire lead and OEM connector. Lamp within is comparable to a #67 bulb and is rated for 8–14V DC.

part no.	description
73462	license/utility light



License Illuminator

Chrome-plated steel construction housing and flat mounting bracket provide these incandescent illuminators shock-proof durability. Equipped with a crystal lens, these lamps are ideal for various applications and are rated for 8–14V DC.

part no.	description
8590	license illuminator



Economy West Coast Mirror

Manufactured with an anodized aluminum body. Equipped with a silvered mirror. The most cost-effective replacement West Coast Mirror.

part no.	description
8640	west coast mirror



Scan for
pricing
or go to
[www.delcity.net/
catalogpricing](http://www.delcity.net/catalogpricing)



8" Round Convex Mirror

Convex 8" mirror is manufactured with a stainless steel housing. Equipped with a center mount 1/4" adjustable ball stud for easy assembly.

part no.	description
8650	convex round mirror



2" Rubber Grommet for Clearance Marker Lamps

This round rubber grommet is manufactured to fit standard 2" LED and incandescent clearance marker lamps. New grommets restore shock protection, security and improve vehicle appearance.

part no.	description
8805	2" round rubber grommet



2-1/2" Rubber Grommet for Clearance Marker Lamps

This round rubber grommet is manufactured to fit standard 2 1/2" LED and incandescent clearance marker lamps. New grommets restore shock protection, security and improve vehicle appearance.

part no.	description
8800	2-1/2" round rubber grommet



4" Rubber Grommet for Stop, Tail, Turn Lamps

This round rubber grommet is manufactured to fit standard 4" LED and incandescent stop, tail, turn lamps. New grommets restore shock protection, security and improve vehicle appearance. Fits a 4.5" mounting hole.

part no.	description
8810	4" round rubber grommet



Oval Rubber Grommet

This oval rubber grommet is manufactured to fit standard oval LED and incandescent stop, tail, turn lamps. New grommets help restore shock protection, security and improve vehicle appearance.

part no.	description
8815	rubber grommet for oval light



Rectangular Rubber Grommet

This rectangular rubber grommet is manufactured to fit standard rectangle LED stop, tail, turn lamps. New grommets help restore shock protection, security and improve vehicle appearance.

part no.	description
8820	rectangular rubber grommet



Scan for pricing or go to www.delcity.net/catalogpricing



4" Stainless Steel Security Flange

Ideal for theft resistance. Easy installation allows lamp to snap into place. Resists corrosion for longevity. Use with standard 4" LED and incandescent stop, tail, turn lamps.

part no.	description
8850	4" security flange

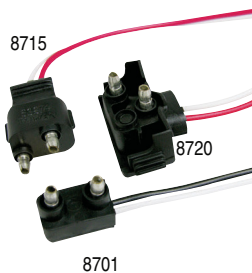

Pigtails 2-contact

Choose from a variety of pigtail plugs to hook-up your single or dual function lamps. Each includes the grounding wire pre-terminated with a ring terminal. The in-line 8701 features 6.5" of lead wire, while the 8715 & 8720 features 11" of lead wire.

part no.	description
8700	2-contact plug
8701	in-line, 2-contact male plug
8715	in-line, 2-contact dual male plug
8720	right angle, 2-contact dual male plug

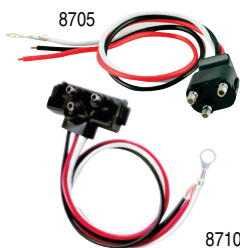

Pigtails 3-contact

3-contact pigtails for use with standard stop, tail, turn lamps. Plugs are manufactured to replace existing pigtails or new installation. Both have 11" of lead wire. Each includes the grounding wire pre-terminated with a ring terminal.

part no.	description
8705	3-contact plug
8710	3-contact, 90° plug



Thin-line Chrome Mounting Bracket

Snap-in lamp design allows for quick installation. Mates with thin-line LED clearance marker lamps (7640 & 7645). Includes twin leads.

part no.	description
8855	mounting bracket, chrome



Mini Rectangular Chrome Mounting Bracket

Mates with 7680 and 7685 clearance marker lamps (page 243). Includes twin leads.

part no.	description
8875	mini chrome mounting bracket



Three-wire Connector

Three-wire connector with fiber-optic cavity. For 2 or 3 terminal sealed-beam head lamps and flashers. 12" 16 gauge lead wire.

part no.	description
73510	three-wire connector



Single Contact License and Utility Lamp

Snap-in fit for 3/4" hole. 12" lead wire. Bulbs: 63, 67, 81, 89, 1002, 1129, 1133, 1141.

part no.	description
73512	single contact license & utility lamp



Scan for pricing or go to www.delcity.net/catalogpricing



Double Contact Park/Stop/Tail/Turn Lamp

Removable adapter plate for 3/4" hole. Weather-resistant boot. 12" lead wire. Bulbs: 1198, 1016, 1034, 1154, 1157.

part no.	description
73514	double contact lamp



Single Contact

Pigtail wire assembly with terminal attached. Socket #'s: 3432, 3433, 3452, 3453, 3460, 3461, 3463, 3470, 3471. Lamp No. 63, 67, 81, 89, 93, 209, 1003, 1073, 1129, 1133, 1141, 1156. SMP: S-23; Wells: 201; Borg: PT5, Nieh: LS-102.

part no.	description
73507	single contact



Double Contact

Pigtail wire assembly with terminals attached. Socket #'s: 3422, 3430, 3434, 3435, 3436. Lamp Nos. 64, 68, 82, 88, 90, 94, 210, 1004, 1034, 1074, 1130, 1154, 1157, 1158, 1175. SMP: S-24; Well: 200; Borg: PT7, Nieh: LS-150.

part no.	description
73509	double contact



Injector Solenoid Connector

EV1 style connector. Fits multi-port injectors GM 1711799 1993-86 (replaces GM 12085491). Bosch & Lucas Injectors on Chrysler, Ford products, AMC/Jeep, Datsun/Nissan, Porsche, Toyota, VW and Volvo 2004 and later.

part no.	description
73522	injector solenoid connector



78590



78604

Halogen Bulbs

Halogen lights are one of the most widely used illumination devices for forward lighting in recent models for the transportation industry. They offer longer life (2 to 3 times as long as an incandescent bulb) and better efficiency (10% to 20% more efficient). These halogen lights are offered in two different styles, a single and dual filament. The single filament is designed specifically for either the high or low beam while the dual filament functions as both.

part no.	description	ANSI #
78590	halogen capsule, hi-low beam	9003
78600	halogen capsule, hi-low beam	9004
78601	halogen capsule, hi beam	9005
78602	halogen capsule, low beam	9006
78603	halogen capsule, hi-low beam	9007
78604	halogen capsule, hi-low beam	9008 (H13)
78606	halogen capsule, low beam	H7
78607	halogen capsule, low beam	H11LL



Halogen Bulb

For automotive, motorcycle and auxiliary lighting. 55 Watt, 12 volts. 12 volts average life (hours): 225. H3 bulb. 1 per box.

part no.	description
78605	halogen bulb



HID Replacement Parts

part no.	description	volts	watts	Replacement For	lumens	warranty
ECCOE94001	H3 halogen bulb	12V DC	55	ECCOE91025 and ECCO91009	1190	1
ECCOE94002	H3 halogen bulb	24V DC	70	ECCOE91025 and ECCO91009	1190	1



Scan for pricing or go to www.delcity.net/catalogpricing



Clear Auto Bulb – DC Index Bulb

This is a standard replacement, dual filament bulb designed for both break and turn signal applications. The filament is a C-6 shape and has an up to 600 hour life expectancy. 10 bulbs per pack. Rated to 2.1A @ 12.8V DC.

part no.	description	ANSI #
78610	clear auto bulb – DC index bulb	1157



78650



78655

Incandescent Bulbs

These bulbs are ideal for automotive, motorcycle and auxiliary lighting. Wedge base securely holds bulb in place while the durable construction provides a trouble free life of the bulb.

part no.	description	base style	ANSI #
78650	clear bulb	wedge	194
78655	clear bulb	wedge	3156
78656	clear bulb	wedge	3157
78657	clear bulb	wedge	4114LL
78658	clear bulb	wedge	4157LL

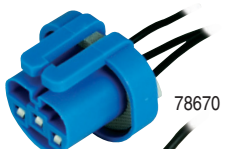

78670



78675

Halogen Headlight Socket

These halogen headlight sockets are ideal replacements for your worn or damaged headlight sockets. With 10" wire leads, each socket will mate with their respective headlamp.

part no.	description
78670	headlight socket fits 9004 or 9007
78675	headlight socket fits 9005
78680	headlight socket fits 9006



73540



73542

Deluxe 12 Volt Plug & Receptacle

Plug "locks" into receptacle and provides a waterproof seal. Easy to install, with supplied mounting plate for front panel installation, or locking ring for rear access installation. Watertight sealing cap on the receptacle; moisture proof sealing ring on the plug. Compatible with standard 12V plug and receptacles. Plug has an internal strain relief and cord seal, with an interchangeable 10A fuse.

part no.	description
73540	locking 12V plug
73542	locking 12V receptacle



Auxiliary 12 Volt Lighter Socket

Lighter plug with protective snap-on cover. Standard .250" push-on terminals for wire connection. 1.10" mounting hole.

part no.	description
73549	auxiliary 12V lighter socket



Snap-in Female Lighter Socket

Lighter plug with protective snap-on cover. Fast mounting expandable clips. Under dash mounting bracket included.

part no.	description
73548	snap-in female lighter socket

BEACONS & MINIBARS

- CLASS I**— Primary warning lamps for authorized emergency vehicles. Four times brighter than CLASS II. Ten times brighter than CLASS III or Type E, ES and EE.
- CLASS II**— Primary warning lamps for authorized maintenance or work vehicles.
- CLASS III**— Primary warning lamps for vehicles that are required to display warning lamps.
- TYPE E, ES & EE**— Primary warning lamps for industrial truck applications.



Scan for pricing or go to www.delcity.net/catalogpricing

ECCO® LED Class I Rotating Beacon



ECCO7660A

LED Hybrid technology provides a high intensity rotating warning signal with no gears, brushes or bulbs to wear out. Eight high-intensity LEDs combined with a TIR optic produce an exceptionally bright warning beam. The polycarbonate lens features a UV hard coating to greatly reduce cracking, hazing, abrasion and fading. Meets SAE J845 Class I (A, B, CB & R). CE, R10. Temperature rating of -22°F to +122°F (-30°C to +50°C).

part no.	description	draw	volts	FPM
ECCO7660A	amber, LED rotating beacon	2.1	12 - 24	125
ECCO7660CA	clear lens, amber, LED rotating beacon	2.1	12 - 24	125
ECCO7660AVM	amber, LED rotating beacon, vac mag mount	2.1	12 - 24	125
ECCO7660CAVM	clear lens, amber, LED rotating beacon, vac mag mount	2.1	12 - 24	125

ECCO® LED Class I Low Profile Beacon



ECCO7460A

The compact and unobtrusive LED beacon incorporates a simple, yet highly effective and robust, design featuring an overhead heatsink that also allows removal of flange when the unit is pipe mounted. The eight 3-watt LEDs and a parabolic reflector creates a highly sensitive peripheral vision unique to Pulse8 flash pattern. Meets SAE J845 Class I (A, CC, CR & R). CA models are class II. CE, e, IP Rating 67. Temperature rating of -22°F to +122°F (-30°C to +50°C).

part no.	description	draw	volts	FPM
ECCO7460A	amber, LED Low profile beacon	3.6	12-36	75 x 8
ECCO7460CA	clear lens, amber, LED low profile beacon	3.6	12-36	75 x 8
ECCO7460CC	clear, LED low profile beacon	3.6	12-36	75 x 8
ECCO7460AVM	amber, LED Low profile beacon, vac mag mount	3.6	12-36	75 x 8
ECCO7460CAVM	clear lens, amber, LED low profile beacon, vac mag mount	3.6	12-36	75 x 8
ECCO7460CCVM	clear, LED low profile beacon, vac mag mount	3.6	12-36	75 x 8

ECCO® LED Class I Beacon



ECCO7965A

This series of beacons has the latest LED technology with a traditional, strobe style housing at a price point comparable to a strobe. It features 11 flash patterns that produce an attention getting warning signal. The beacons have an aluminum base with polycarbonate lens. Vacuum magnet mount models have a switched cigarette plug adapter. Available in 5" or 7" height profiles. Meets SAE J845 Class I rating. Rated to -22°F to +122°F (-30°C to +50°C).

part no.	description	draw	volts
ECCO7965A	5", amber, LED rotating beacon	2.8	12-24
ECCO7965C	5", clear, LED rotating beacon	2.8	12-24
ECCO7965AVM	5", amber, LED rotating beacon, vac mag mount	2.8	12-24
ECCO7965CVM	5", clear, LED rotating beacon, vac mag mount	2.8	12-24
ECCO7970A	7", amber, LED rotating beacon	2.8	12-24
ECCO7970C	7", clear, LED rotating beacon	2.8	12-24
ECCO7970AVM	7", amber, LED rotating beacon, vac mag mount	2.8	12-24
ECCO7970CVM	7", clear, LED rotating beacon, vac mag mount	2.8	12-24



Scan for pricing or go to www.delcity.net/catalogpricing



10110

ECCO® High Intensity Class I LED Beacon



These heavy-duty, steel base LED beacons offer 16 high intensity 3-watt LEDs that provide the brightest light output available in a LED beacon making them an ideal upgrade to your current rotating or strobe beacon. The beacon's LED technology offers a dual/quad flash and low/high intensity adjustment via an adjustable dip switch beneath the lens. LEDs also reduce overall downtime and maintenance hassles caused from bulb replacements. LED beacon 10110 offers an integral flange for three bolt flush mount or 1" pipe mounting and is pre-wired for ease of installation. LED beacon 10115 offers a vacuum magnet mount feature with a 15' cord and 12V DC lighter plug. AMECA certified for SAE J854 Class I applications, R10, CE.

part no.	description	draw	volts	FPM
10110	amber, LED beacon	3.7	12-24	80/65
10115	amber, LED beacon, mag mount	3.7	12-24	80/65



ECCO7160A

ECCO® LED Class I Synch Beacon



This beacon provides the ultimate level of power, versatility and style available in an LED beacon. The synching mechanism allows for multiple units to be synched up. It has up to 15 flash patterns with both high and low settings. The vacuum magnet mount comes with a cigarette plug with on/off and flash pattern switch functionality. Meets SAE J845 Class I (A, CA & CC Only). California Title 13 (A, CA & CC Only). CE, R10, IP Rating 66 (3-bolt mount). Temperature rating of -22°F to +122°F (-30°C to +50°C).

part no.	description	draw	volts
ECCO7160A	amber, LED synch beacon	2.0	12-24
ECCO7160CA	clear lens, amber, LED synch beacon	2.0	12-24
ECCO7160CC	clear, LED synch beacon	2.0	12-24
ECCO7160AVM	amber, LED synch beacon, vac mag mount	2.0	12-24
ECCO7160CAVM	clear lens, amber, LED synch beacon, vac mag mount	2.0	12-24
ECCO7160CCVM	clear, LED synch beacon, vac mag mount	2.0	12-24



ECCO® High Intensity Class I Strobe Beacon



These high intensity dual (75FPM)/quad (65FPM) flash strobe beacons offer a die cast aluminum base, thread-on polycarbonate lens and Smartstrobe® feature that automatically adjusts to day or night operating intensity making them ideal for refuse, dump trucks or other larger work trucks. The medium profile beacon (6.7"x 6.5") offers an integral flange for three bolt flush mount or 1" pipe mounting and is pre-wired for ease of installation. Beacons are reverse polarity, voltage spike and surge protected, and AMECA certified to SAE J1318 Class I, CE.

part no.	description	draw	volts	FPM
10040	amber, medium profile beacon	2.6	12-24	75/65



ECCO7945A

ECCO® LED Class II Beacon



This series of beacons has the latest LED technology with a traditional, strobe style housing at a price point comparable to a strobe. It features a Pulse8 (8 flash per cycle) flash pattern to produce an attention getting warning signal. The beacons have a nylon base with polycarbonate lens. Vacuum magnet mount models have a switched cigarette plug adapter. Available in 5" or 7" height profiles. Meets SAE J845 Class II rating. Rated to -22°F to +122°F (-30°C to +50°C).

part no.	description	draw	volts	FPM
ECCO7945A	5", amber, LED rotating beacon	2.5	12-48	70 x 8
ECCO7945C	5", clear, LED rotating beacon	2.5	12-48	70 x 8
ECCO7945AVM	5", amber, LED rotating beacon, vac mag mount	2.5	12-48	70 x 8
ECCO7945CVM	5", clear, LED rotating beacon, vac mag mount	2.5	12-48	70 x 8
ECCO7950A	7", amber, LED rotating beacon	2.5	12-48	70 x 8
ECCO7950C	7", clear, LED rotating beacon	2.5	12-48	70 x 8
ECCO7950AVM	7", amber, LED rotating beacon, vac mag mount	2.5	12-48	70 x 8
ECCO7950CVM	7", clear, LED rotating beacon, vac mag mount	2.5	12-48	70 x 8

NEW

ECCO® Class I LED Severe Vibration Beacons

ECCO7975A



Heavy Duty series LED beacons have the latest LED technology with a traditional, strobe style housing. Features a Pulse 8 (8 flash per cycle) flash pattern to produce an attention getting warning signal. Ideally suited for severe vibration applications including mining, construction and waste management. Beacons have a reinforced polypropylene base with polycarbonate lens. Available in 5" or 7" height profiles. Meets SAE J845 Class I rating. Temperature rating of -22°F to +122°F (-30°C to +50°C).

part no.	description	draw	volts
ECCO7975A	SAE Class 1 LED Severe Vibration Beacon, Amber, 5"	2.8	12-24
ECCO7980A	SAE Class 1 LED Severe Vibration Beacon, Amber, 7"	2.8	12-24



Scan for pricing or go to www.delcity.net/catalogpricing

NEW

ECCO® Class II LED Severe Vibration Beacons

ECCOEB7930A



Heavy-duty series of LED beacons has the latest LED technology with a traditional, strobe style housing. Features 11 flash patterns to produce an attention getting warning signal. Suited for severe vibration applications including mining, construction and waste management. Beacons have an aluminum base with polycarbonate lens. Available in 5" or 7" height profiles. Meets SAE J845 Class II rating. Temperature rating of -22°F to +122°F (-30°C to +50°C).

part no.	description	draw	volts
ECCOEB7930A	SAE Class 2 LED Severe Vibration Beacon, Amber, 5"	7.5	12-48
ECCOEB7930C	SAE Class 2 LED Severe Vibration Beacon, Clear, 5"	7.5	12-48
ECCOEB7935A	SAE Class 2 LED Severe Vibration Beacon, Amber, 7"	7.5	12-48
ECCOEB7935C	SAE Class 2 LED Severe Vibration Beacon, Clear, 7"	7.5	12-48

ECCO® LED Class III Beacon

ECCO6465A

ECCO's 6465 Series LED beacon features a Pulse8 flash pattern that produces a warning signal ideal for industrial-type applications. This cost-effective light features a wide operating range and durable reinforced-nylon base and polycarbonate lens make it ideal for use on electric vehicles. Meets SAE Class III, CE, R10. Temperature rating of -22°F to +122°F (-30°C to +50°C).

part no.	description	draw	volts	FPM
ECCO6465A	amber, LED beacon	2.7	12-80	70 x 8
ECCO6465C	clear, LED beacon	2.7	12-80	70 x 8
ECCO6465AMG	amber, LED beacon, vac mag mount	2.7	12-80	70 x 8
ECCO6465CMG	clear, LED beacon, vac mag mount	2.7	12-80	70 x 8

ECCO® LED Class III Low Intensity Industrial Beacon

ECCO6262A

ECCO's maintenance-free 6260 Series LED Beacons feature three of the latest 3-watt LEDs and Pulse8 flash operation produce a warning signal ideal for industrial applications. These beacons are reverse polarity, voltage spike and surge protected. The reinforced-nylon base houses the epoxy-sealed electronics for a superior environmental protection. Meets SAE Class III, R10, IP66167. Temperature rating of -22°F to +122°F (-30°C to +50°C).

part no.	description	draw	volts	FPM
ECCO6262A	amber, LED beacon, 2 bolt mount, side wire	2.7	12-80	70 x 8
ECCO6263A	amber, LED beacon, 2 bolt mount, bottom wire	2.7	12-80	70 x 8
ECCO6267A	amber, LED beacon, 1/2" pole mount	2.7	12-80	70 x 8



Scan for pricing or go to www.delcity.net/catalogpricing



10060



ECCO® Low-Profile Class I Rotating Beacon



This economical low profile rotating beacon provides 160 flashes per minute and incorporates a belt drive with stainless steel bearings for long life and reliable service. Combined with a polycarbonate base, twist-on lens and 55-watt halogen bulb, they are available in a standard 3 bolt flange and 1" pipe mount, or in a vacuum magnet mount designed for use up to 65 mph. AMECA certified for SAE J854, 12 Volt Class I applications.

part no.	description	draw	volts	FPM
10060	amber, low profile beacon	6.7	12	160
10065	amber, low profile beacon mag mount	6.7	12	160



ECCO® Medium Profile Low Intensity Strobe Beacon



This economical low intensity and compact strobe (3.9"x 5.5"x 2.8") operates as a single flash strobe producing 1.5 joules making it ideal for small industrial lift trucks, material handling or electric cart applications. An integral flange allows for two bolt flush mount or 1" pipe mounting and beacon is pre-wired for ease of installation. The medium profile polycarbonate lens illuminates 360° nylon base and encapsulated circuit board protects against moisture, dust and vibration. Beacons are reverse polarity, voltage spike and surge protected and are designed to be used in Type E, ES and EE industrial trucks.

part no.	description	draw	volts	FPM
10010DL	amber, medium profile beacon	0.3	12-80	85



10015



10020

ECCO® Low Profile Low Intensity Strobe Beacon



This economical low intensity and compact strobe (3.9"x 5.1") operates as a single flash strobe, producing 1.5 joules, making it ideal for small industrial lift trucks, material handling or electric cart applications. Beacon 10015 offers an integral flange for three bolt flush mount or 1" pipe mounting and is pre-wired for ease of installation. Beacon 10020 offers a vacuum magnet mount feature with a 15' cord and 12V DC lighter plug. Beacons are reverse polarity, voltage spike and surge protected.

part no.	description	draw	volts	FPM
10015	amber, low profile beacon	0.3	12-80	70
10020	amber, low profile beacon, mag mnt	0.3	12-80	70



10025



10035DL

ECCO® Medium-duty Class II Strobe Beacon



These medium-duty dual (80FPM)/quad (65FPM) flash strobe beacons offer a glass filled nylon base and thread-on polycarbonate lens making them ideal for on-the-road delivery vehicles such as mini-vans or pick-up trucks. Low profile 10025 beacon (4.8"x 6.5") offers an integral flange for three bolt flush mount or 1" pipe mounting and is pre-wired for ease of installation. Low profile 10030 beacon (4.8"x 6.5") offers a vacuum magnet mount feature with a 15' cord and 12V DC lighter plug. Medium profile beacon (6.7"x 6.5") offers an integral flange for three bolt flush mount or 1" pipe mounting and is pre-wired for ease of installation. Beacons are reverse polarity, voltage spike and surge protected, and AMECA certified to SAE J1318 Class II, CE, R10.

part no.	description	draw	volts	FPM
10025	amber, low profile beacon	2.4	12-48	80/65
10030	amber, low profile beacon mag mount	2.4	12-48	80/65
10035DL	amber, medium profile beacon	2.4	12-48	80/65

**ECCO® LED Class I Hybrid Rotator Mini Bar**

ECCO5280A

The 5280 Series Minibar features LED hybrid technology that uses a brushless magnetic-drive system to spin the reflector disk, reducing noise and eliminating the typical motor/gear drawbacks associated with conventional rotators. Each hybrid module also features 8 high-intensity LEDs and TIR optic, providing SAE Class 1 light output. The UV hard coated lens reduces abrasion, cracking and fading. Meets SAE J845 Class I, IP Rating 67, CE, R10. Temperature rating of -22°F to +122°F (-30°C to +50°C).



Scan for pricing or go to www.delcity.net/catalogpricing

part no.	description	draw	volts	flash pattern
ECCO5280A	15" amber, LED hybrid mini bar	4.0	12-24	360, rotate
ECCO5280AMG	15" amber, LED hybrid mini bar magnet mount	4.0	12-24	360, rotate

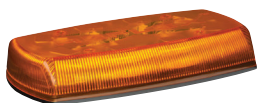
ECCO® LED Class I Mini Bar

ECCO5585A

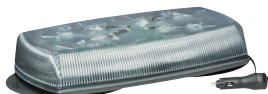

ECCO5585CCVM

Class 1 LED minibars provide a powerful warning solution that offers the flexibility of either permanent or vacuum-magnet mounting. They feature eight LED modules, each comprising of three LEDs of high intensity light output. The mini bar can also be synchronized (permanent mount only). Vacuum mount comes with a cigarette plug with a on/off and flash pattern selectable switch. Meets SAE J845 Class I, California Title 13, CE, e. Temperature rating of -22°F to +122°F (-30°C to +50°C). *ECCO5585CRB and ECCO5585CRBVM are not available for use on public roads by private vehicles.

part no.	description	draw	volts	flash pattern
ECCO5585A	15" amber, LED mini bar	5.1	12-24	18
ECCO5585CA	15" clear lens, amber, LED mini bar	5.1	12-24	18
ECCO5585CB	15" clear lens, blue, LED mini bar	5.1	12-24	18
ECCO5585CC	15" clear, LED mini bar	5.1	12-24	18
ECCO5585CG	15" clear lens, green, LED mini bar	5.1	12-24	18
ECCO5585CR	15" clear lens, red, LED mini bar	5.1	12-24	18
ECCO5585CAC	15" clear lens, split amber/clear, LED mini bar	5.1	12-24	18
ECCO5585CAB	15" clear lens, split amber/blue, LED mini bar	5.1	12-24	18
ECCO5585CAR	15" clear lens, split amber/red, LED mini bar	5.1	12-24	18
ECCO5585CAG	15" clear lens, split amber/green, LED mini bar	5.1	12-24	18
ECCO5585CRB	15" clear lens, split red/blue, LED mini bar	5.1	12-24	18
ECCO5585AVM	15" amber, LED mini bar, vac mag mount	5.1	12-24	18
ECCO5585CAVM	15" clear lens, amber, LED mini bar, vac mag mount	5.1	12-24	18
ECCO5585CBVM	15" clear lens, blue, LED mini bar, vac mag mount	5.1	12-24	18
ECCO5585CCVM	15" clear, LED mini bar, vac mag mount	5.1	12-24	18
ECCO5585CGVM	15" clear lens, green, LED mini bar, vac mag mount	5.1	12-24	18
ECCO5585CRVM	15" clear lens, red, LED mini bar, vac mag mount	5.1	12-24	18
ECCO5585CACVM	15" clear lens, split amber/clear, LED mini bar, vac mag mount	5.1	12-24	18
ECCO5585CABVM	15" clear lens, split amber/blue, LED mini bar, vac mag mount	5.1	12-24	18
ECCO5585CARVM	15" clear lens, split amber/red, LED mini bar, vac mag mount	5.1	12-24	18
ECCO5585CAGVM	15" clear lens, split amber/green, LED mini bar, vac mag mount	5.1	12-24	18
ECCO5585CRBVM	15" clear lens, split red/blue, LED mini bar, vac mag mount	5.1	12-24	18



Scan for pricing or go to www.delcity.net/catalogpricing



ECCO5590A

ECCO® LED Class I Mini Bar



The 5590 uses high intensity LEDs that combines and corners discrete optic and reflective technology to maximize light output. This provides an intense, focused signal to the front and rear as well as wide angle warning to the sides. Users can select from 18 flash patterns, either via trigger wire on permanent mount models or cigarette plug switch on magnetic models. Meets SAE J845 Class I, California Title 13, CE, R10, IP65. Temperature rating of -22°F to +122°F (-30°C to +50°C).

part no.	description	draw	volts	flash pattern
ECCO5590A	15" amber, LED high intensity mini bar	6.0	12-24	18
ECCO5590CA	15" clear lens, amber, LED high intensity mini bar	6.0	12-24	18
ECCO5590CAVM	15" amber, LED high intensity mini bar, vac mag mount	6.0	12-24	18
ECCO5590AVM	15" clear lens, amber, LED high intensity mini bar, vac mag mount	6.0	12-24	18



ECCO5580A

ECCO® LED Class II Mini Bar



The Class II LED minibars provide a compact warning solution that offers the flexibility of either permanent or vacuum-magnet mounting. Eight LED modules, each comprising of three LEDs provides high intensity light output amplified with the reflective technology to maximize light output. The permanent mount model offers users the choice of 18 user selectable flash patterns. Meets SAE J845 Class II, CE, R10. Temperature rating of -22°F to +122°F (-30°C to +50°C).

part no.	description	draw	volts	flash pattern
ECCO5580A	15" amber, LED mini bar	2.7	12-24	18
ECCO5580CA	15" clear lens, amber, LED mini bar	2.7	12-24	18
ECCO5580AVM	15" amber, LED mini bar, vac mag mount	2.7	12-24	18
ECCO5580CAVM	15" clear lens, amber, LED mini bar, vac mag mount	2.7	12-24	18



10050

ECCO® 15" High Intensity Rotating Minibar



These low profile high performance belt-driven minibars offer a unique free-form optics rotator module that provides a high intensity light output making them ideal for various work truck applications that require a Class I rating. Low profile 10045 minibar (4.5"x 15.75") offers a bolt down permanent mount and is pre-wired for ease of installation. Low profile 10050 minibar (5.1"x 15.75") offers a vacuum magnet mount feature with a 17' cord and 12V DC lighter plug. Minibars carry an IP 54, SAE J845 Class I rating, CE.

part no.	description	amps	volts	FPM
10045	amber, 15" low profile minibar	11	12	480
10050	amber, 15" low profile minibar, magnet mount	11	12	480



ECCO® 22" High Visibility Class I Rotating Minibar



These economical self-lubricating motor and gear rotator assembly minibars offer a high visibility light making them ideal for various work truck applications that require a Class I rating. The rugged with polycarbonate lens and coated aluminum base houses two rotating 50-watt halogen bulbs with a fixed center mirror. These minibars carry a SAE J845 Class I rating, CE.

part no.	description	amps	volts	FPM
10055	amber, 22" low profile minibar	8.6	12	400



LED 1" Micro Strobes 

The micro strobes are ideal for emergency, warning and safety applications. They feature 11 selectable flash patterns and are capable of alternating or synchronized flashing. Mounting is made easy with supplied grommet and stainless steel bezel, into a 1" mounting hole. Each lamp is pre-wired with individual control module. Rated to 210MA max draw @ 12.8V DC.

part no.	description
10130	LED, 1" micro strobe, red, 1 diode
10131	LED, 1" micro strobe, white, 1 diode
10135	LED, 1" micro strobe, amber, 1 diode
10132	LED, 1" micro strobe, blue-clear lens, 1 diode



Scan for pricing or go to www.delcity.net/catalogpricing



ECCO® LED Safety Arrows 

The LED Safety Director Arrow is the definitive traffic direction lighting solution. 16 individual lamps project high intensity warning in low profile unit. The in-cab controller allows used to safely change from 32 user-selectable flash patterns from inside the vehicle. Temperature rating of -22°F to +122°F (-30°C to +50°C).

part no.	description
ECCOED0007A	15" amber LED safety director



ECCO® Safety Director LED with Controller   

The 3410 LED Safety Director is a compact high-intensity warning system designed to direct traffic approaching from the rear of a stationary vehicle. The compact light-stick design allows for unobtrusive interior or exterior mounting. Mount either flush to the vehicle or using the provided mounting brackets. Housing is manufactured from extruded aluminum and houses the eight reflective modules with 6 LEDs each. The modern, soft touch controller provides a fingertip control of nine built-in flash patterns and features an LED display that mimics the selected pattern in real time. ECCO3410A meets SAE J845 Class I, CE, R10. Temperature rating of -22°F to +122°F (-30°C to +50°C).

part no.	description
ECCO3410A	LED safety signal director w/controller, 15' cable
ECCO3410CB	safety director controller
ECCO3410LBA	signal bar, LED
ECCO341015	15-ft safety signal bar cord
ECCO341035	35-ft safety signal bar cord
ECCO341055	55-ft safety signal bar cord



shrink tube - crimp



gauge	butted seam	seamless	brazed barrel	tubing ID
24-22	920005	—	—	.125
22-18	—	921005	—	.186
16-14	—	922005	—	.216
12-10	—	923005	—	.279
8	—	—	924005	.330



shrink tube - crimp & solder

gauge	brazed barrel	tubing ID
22-18	981005	.186
16-14	982005	.216
12-10	983005	.279



Scan for pricing or go to www.delcity.net/catalogpricing



ECCO3945C

ECCO® Class I 4" Round Grommet Mount LED Directional



These independent LED directional lights offer long-life, low-maintenance operation with no moving parts or bulbs/flashtubes to break or replace. Simply fit in standard round rear lighting grommets. Single, slow single, fast single, double, fast double, quad, quint and warp flash patterns. Meets SAE J595 Class I. Temperature rating of -22°F to +122°F (-30°C to +50°C).

part no.	description
ECCO3945A	LED 4" round grommet mount, amber
ECCO3945C	LED 4" round grommet mount, clear

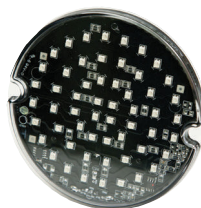

ECCO3921A

ECCO® 4" Round Slim Line LED Grommet Mount Directional



These versatile LEDs offer a choice of either grommet or surface mounting. Comprised of 56 high intensity LEDs, these lights feature 15 flash patterns and have a simple 3 wire hook-up. Choose from surface or grommet mount.

part no.	description
ECCO3921A	Slim Line Grommet Mount, LED, Round, Amber (1 MIN)
ECCO3912A	Slim Line Surface Mount, LED, Round, Amber (1 MIN)



ECCO3965C

ECCO® Class I Oval Grommet Mount LED Directional



These independent LED directional lights offer long-life, low-maintenance operation with no moving parts or bulbs/flashtubes to break or replace. Simply fit in standard oval rear lighting grommets. Single, slow single, fast single, double, fast double, quad, quint and warp flash patterns. Meets SAE J595 Class I. Temperature rating of -22°F to +122°F (-30°C to +50°C).

part no.	description
ECCO3965A	LED oval grommet mount, amber
ECCO3965C	LED oval grommet mount, clear



ECCO3920A

ECCO® Oval Slim Line LED Grommet Mount Directional



These versatile LEDs offer a choice of surface or grommet mounting. Comprised of 56 high intensity LEDs, these lights feature 15 flash patterns and have a simple 3 wire hook-up. Choose from surface or grommet mount.

part no.	description
ECCO3920A	Slim Line Grommet Mount, LED, Oval, Amber (1 MIN)
ECCO3911A	Slim Line Surface Mount, LED, Oval, Amber (1 MIN)



ECCO3910A

ECCO® Slim Line LED Grommet Mount Directional



These versatile LEDs are surface mounted. They are comprised of 56 high intensity LEDs, these lights feature 15 flash patterns and have a simple 3 wire hook-up.

part no.	description
ECCO3930A	Slim Line Surface Mount, LED, Square, Amber (1 MIN)
ECCO3910A	Slim Line Surface Mount, LED, Rounded Corner Square, Amber (1 MIN)

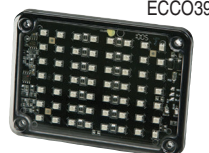

ECCO3930A



ECCO® Slim Line LED Grommet Mount Directional



Surface and bracket (bracket included) LED directional light offers long-life, low maintenance with no moving parts or flashtubes to break or replace. This premium LED head features a clear polycarbonate lens with four LEDs that illuminate in the color of your choice. The lights can be synchronized and the warning capability can be customized by selecting from 24 flash patterns and synchronizing multiple heads simultaneously or alternately. Weatherproof IP67 rating. SAE J595 Class I (light output only). Temperature rating of -22°F to +122°F (-30°C to +50°C).



Scan for pricing or go to www.delcity.net/catalogpricing

part no.	description
ECCOED0001A	surface/bracket LED directional, amber
ECCOED0001B	surface/bracket LED directional, blue
ECCOED0001C	surface/bracket LED directional, clear
ECCOED0001R	surface/bracket LED directional, red



ECCO3510A

ECCO® Class I LED Directional, Surface Mount



The surface mount LED warning light is designed to offer maximum performance with minimum size. This slimline LED measures only 3.3" x 1.1" and only .04" deep, comprising of 24 1-watt high-intensity LEDs in an ultra compact housing. An in-line waterproof driver module allows for premium functionality and compact size. Comes pre-wired with 9-ft cable. Meets SAE J595 Class I (Amber, Blue, Clear, Red). California Title 13 (Amber, Blue, Red). Meets SAE J845 class II, CE, IP67. Temperature rating of -22°F to +122°F (-30°C to +50°C).

part no.	description
ECCO3510A	16 flash, LED directional, surface mount, amber
ECCO3510B	16 flash, LED directional, surface mount, blue
ECCO3510C	16 flash, LED directional, surface mount, red
ECCO3510R	16 flash, LED directional, surface mount, clear



ECCO3715A

ECCO® Class I LED Directional, Surface Mount



The surface mount LED warning light is designed to offer maximum performance with minimum size. This slimline LED measures only 3.3" x 1.1" and only .04" deep, comprising of 24 1-watt high-intensity LEDs in an ultra compact housing. An in-line waterproof driver module allows for premium functionality and compact size. Comes pre-wired with 9-ft cable. Multiple heads can be synchronized. Four high-intensity LEDs combine with TIR optics to provide high-intensity directional warning. Units are colorless when not illuminated. California Title 13 (Amber, Blue, Red). Meets SAE J845 class II, CE, IP67. Temperature rating of -22°F to +122°F (-30°C to +50°C).

part no.	description
ECCO3715A	9 flash, LED directional, surface mount, amber
ECCO3515C	9 flash, LED directional, surface mount, clear

ECCO® Class II LED Directional, Surface Mount CE



This compact surface-mount LED directional light has premium LED heads and that illuminate in the color of your choice (lights are colorless when not powered). Ideal for applications requiring high intensity output, low-current draw and no-maintenance operation. ECCO3730 can be synchronized to produce customized look. The coated aluminum base and urethane-sealed electronics protect the unit against the environment, making this one of the most rugged LED products available. Meets SAE J845 Class II (amber ECCO3730 only). CE, e. IP Rating 67 (ECCO3730 series only). CE, R10 ECCO3735 series. Temperature rating of -22°F to +122°F (-30°C to +50°C).

part no.	description
ECCO3730A	14 flash, LED directional, surface mount, amber
ECCO3730C	14 flash, LED directional, surface mount, clear
ECCO3735A	11 flash, LED directional, surface mount, amber
ECCO3735C	11 flash, LED directional, surface mount, clear





Scan for pricing or go to www.delcity.net/catalogpricing



ECCO3811



ECCO3861

LED Quad Flash Class I Lights



These directional LEDs comprise 20 high intensity LEDs with individual reflectors to provide truly outstanding light output in a very cost-effective package. Featuring 7 flash patterns and synchronization capability, they are available in either surface or grommet mount configurations, offering fit-and-forget maintenance-free operation and low amp draw. Lights have a tough, clear polycarbonate housing with encapsulated electronics. These flash lights are rated SAE J595 Class I, CE, and R10. Temperature range: -22°F to 122°F (-30°C to +50°C).

part no.	description
ECCO3811A	rectangle, quad flash, LED surface mount, amber
ECCO3811B	rectangle, quad flash, LED surface mount, blue
ECCO3811C	rectangle, quad flash, LED surface mount, clear
ECCO3811R	rectangle, quad flash, LED surface mount, red
ECCO3861A	oval, quad flash, LED grommet mount, amber
ECCO3861B	oval, quad flash, LED grommet mount, blue
ECCO3861C	oval, quad flash, LED grommet mount, clear
ECCO3861R	oval, quad flash, LED grommet mount, red

ECCO® Concealed Surface Mount LED Directional Light



These surface mounted lights are a high intensity, directional LED warning light specifically designed for vehicle headlight and tail light applications. The six 1-watt LED can be programmed to 16 different flash patterns. The in-line waterproof driver module eliminates need for a remote power supply. It is manufactured with a UV stabilized polycarbonate lens, nickel-plated housing and comes with a 9-ft cable.

part no.	description
ECCO9014A	surface mount, directional LED, amber
ECCO9014B	surface mount, directional LED, blue
ECCO9014C	surface mount, directional LED, clear
ECCO9014R	surface mount, directional LED, red

NEW

ECCO® Class I Dual Color LED Directionals



ECCOED3766AB



The dual color surface directional light offers the flexibility of two different color outputs within a single unit, comprised of 12 high intensity LEDs, six of each color. With the choice of 11 flash patterns and synchronization capability, it allows for an attention-getting multi-color warning system with half the number of lights typically required. Each model can be programmed to flash either color option individually or alternate colors. Meets SAE J595 Class I, California Title 13, R65, R10. Temperature rating of -22°F to +122°F (-30°C to +50°C).

part no.	description
ECCOED3766AB	Dual Color Amber/Blue LED Directional, Class I, 12 LEDs
ECCOED3766AC	Dual Color Amber/Clear LED Directional, Class I, 12 LEDs
ECCOED3766AG	Dual Color Amber/Green LED Directional, Class I, 12 LEDs
ECCOED3766AR	Dual Color Amber/Red LED Directional, Class I, 12 LEDs
ECCOED3766RB	Dual Color Amber/Blue LED Directional, Class I, 12 LEDs



Clear-View™ Crimp & Shrink Terminal & Heat Shrink Tube Kit – The Clear-Maxxx™

This kit features all three Clear-View™ butt connectors and Clear-View™ heat shrink in three different sizes. It contains 125 total pieces, including 20–18, 16–14, and 12–10 gauge butt connectors and 6" pieces of heat shrink. All are contained within a durable, lightweight, translucent carrying case (11" x 6-3/4" x 1-3/4").

For a complete listing of kit contents, see page 319.

part no.	description	pieces
818	Clear-Maxxx™ terminal kit	125



ECCO® Self Adhesive LED Warning Lights

Stick-A-LED™ warning lights are compact, high intensity auxiliary LEDs designed to provide a powerful warning signal with fast and easy installation. The self-adhesive, peel and stick backing allows placement on any flat surface. It requires only a single wiring hole and a simple two wire connection. Meets CE, R10, IP66 standards. Temperature rating of -22°F to +122°F (-30°C to +50°C).



part no.	description
ECCOED0002A	self adhesive, LED oval,light, amber
ECCOED0002B	self adhesive, LED oval,light, blue
ECCOED0002C	self adhesive, LED oval,light, clear
ECCOED0002R	self adhesive, LED oval,light, red
ECCOED0003A	self adhesive, LED triangle, amber
ECCOED0003B	self adhesive, LED triangle, blue
ECCOED0003C	self adhesive, LED triangle, clear
ECCOED0003R	self adhesive, LED triangle, red
ECCOED0004A	self adhesive, LED rectangle, amber
ECCOED0004B	self adhesive, LED rectangle, blue
ECCOED0004C	self adhesive, LED rectangle, clear
ECCOED0004R	self adhesive, LED rectangle, red



Scan for pricing or go to www.delcity.net/catalogpricing

ECCO® Dash and Window Mount LED Warning Lights



The dash and window mount LEDs compact and versatile. The high intensity directional LED warning lights are suitable for mounting anywhere on a vehicle. These lights are plugged into a 12V power outlet and comes with an on/off and flash pattern select switches. Meets SAE J595 Class I, CE, R10. California Title 13 (Amber, Blue & Red Configurations). Temperature rating of -22°F to +122°F (-30°C to +50°C).



part no.	description
ECCO3611A	single grille, deck/dash & window mount, amber
ECCO3611C	single grille, deck/dash & window mount, clear
ECCO3611B	single grille, deck/dash & window mount, blue
ECCO3611R	single grille, deck/dash & window mount, red
ECCO3611AC	single grille, deck/dash & window mount, amber/clear
ECCO3611RB	single grille, deck/dash & window mount, red/blue
ECCO3612AA	twin grill, deck/dash & window mount, amber/amber
ECCO3612CC	twin grill, deck/dash & window mount, clear/clear
ECCO3612AC	twin grill, deck/dash & window mount, amber/clear
ECCO3612AR	twin grill, deck/dash & window mount, amber/red
ECCO3612AB	twin grill, deck/dash & window mount, amber/blue
ECCO3612CR	twin grill, deck/dash & window mount, clear/red
ECCO3612RB	twin grill, deck/dash & window mount, red/blue

ECCO® Hide-A-LED Bullet Warning Lights



The Hide-A-LED Bullet is a concealed LED warning light that features two high-intensity 3-watt LEDs to deliver an exceptionally bright warning signal with up to 16 flash patterns. Available with 3/4" or 2" shaft lengths, the Bullet is designed to allow quick and easy installation in any headlight or tail light casing. Requiring only a single 1/2" hole, the Bullet's shape overcomes the problem of difficult installation in the highly compact, double wall design of modern vehicle casings. It's self-adhesive and requires no mounting hardware (can be secured with screws). An in-line waterproof driver module eliminates need for a remote power supply. 9-ft cable included.



part no.	description	amps	volts	lumens
ECCOED0010A	Hide-A-LED Bullet, 3/4" shaft, amber	0.7	12-24V DC	200
ECCOED0010C	Hide-A-LED Bullet, 3/4" shaft, clear	0.7	12-24V DC	460
ECCOED0010B	Hide-A-LED Bullet, 3/4" shaft, blue	0.7	12-24V DC	100
ECCOED0010R	Hide-A-LED Bullet, 3/4" shaft, red	0.7	12-24V DC	200
ECCOED0011A	Hide-A-LED Bullet, 2" shaft, amber	0.7	12-24V DC	200
ECCOED0011C	Hide-A-LED Bullet, 2" shaft, clear	0.7	12-24V DC	460
ECCOED0011B	Hide-A-LED Bullet, 2" shaft, blue	0.7	12-24V DC	100
ECCOED0011R	Hide-A-LED Bullet, 2" shaft, red	0.7	12-24V DC	200

lighting

Work Lights



Scan for pricing or go to www.delcity.net/catalogpricing

Whether you are hooking up your trailer, winching a vehicle or illuminating the field in front of you, Del City has a line of lamps to help you get your job done. Choose from LED, HID or halogen models for the light. Then pick the style style and light pattern to get the perfect fit for your application.

LED LIGHTS

Longer Life LED lamps have up to a 100,000 hour rated life, which results in lower long-term costs. While traditional incandescent lamps last 1–2 years before replacement is needed, LED lamps can have a life expectancy of up to 20 years.

Brighter Illumination LED lamps are brighter and illuminate faster with a lower current draw. Incandescent bulbs can lose up to 90% of their energy in light blocked by colored lenses; LEDs deliver 100% of their energy as colored light.

Greater Durability LED lamps are shock and vibration resistant. Most circuits are epoxy resin coated to resist moisture and corrosion. For added assurance, polycarbonate lenses and housings are sonically sealed (excluding 7650 & 7655).

LED Oval Worklamps



ECCOE92001

ECCOE92002

part no.	description	pattern	rating	volts	raw lumens	warranty
ECCOE92001	oval, 6-3 watt LED worklamp	flood	IP67	12-24V DC @ 0.7A	550	3
ECCOE92002	oval, 7-3 watt LED worklamp	spot	IP67	12-24V DC @ 0.9A	640	3

LED Round Worklamps



part no.	description	pattern	rating	volts	raw lumens	warranty
ECCOE92005	round, 8-3 watt LED worklamp	flood	IP67	12-24V DC @ 1.2A	1000	2
ECCOE92004	round, 6-3 watt LED worklamp	flood	IP67	12-24V DC @ 1.1A	800	2
7995	round 6-1 watt LED worklamp	flood	N/A	12.8V DC @ 0.12A	550	N/A
ECCOE92431*	round, 14-3 watt LED, extreme-duty worklamp	flood	IP67	12-24V DC @ 3.1A	2600	2

LED Square Worklamp



ECCOE92023



ECCOE92003

part no.	description	pattern	rating	volts	raw lumens	warranty
ECCOE92401	square, 4-3 watt LED, extreme-duty worklamp	flood	IP67	12-24V DC @ 0.9A	600	2
*ECCOE92421	square, 16-3 watt LED extreme-duty worklamp	flood	IP67	10-30V DC @ 2.7A	2600	2
ECCOE92008	square, 30-3 watt LED extreme-duty worklamp	flood	IP68	12-24V DC @ 1.2A	2300	2
ECCOE92006	square, 9-3 watt LED extreme-duty worklamp	flood	IP67	12-24V DC @ 1.6A	1350	2
ECCOE92007	square, 5-3 watt LED extreme-duty worklamp	flood	IP67	12-24V DC @ 1.0A	750	2

* CE rated



Scan for pricing
or go to
[www.delcity.net/
catalogpricing](http://www.delcity.net/catalogpricing)



ECCOE92020

LED Rectangle Worklamp

part no.	description	pattern	rating	volts	raw lumens	warranty
**ECCOE92411	rectangular, 6-3 watt LED worklamp	flood	IP 67	12-24V DC @ 1.3A	1000	2
*ECCOE92501	rectangular, 5-10 watt LED extreme-duty worklamp	flood	IP67	12-24V DC @ 3.2A	2900	2
ECCOE92301	rectangular, 6-10 watt LED extreme-duty worklamp	flood	-	12-24V DC @ 2.8A	3050	3
ECCOE92300	rectangular, 6-10 watt LED, extreme-duty glass lens worklamp	spot	-	12-24V DC @ 2.8A	3100	3

* CE rated

** EC & R10 rated, 2 year warranty



ECCOE92013

HID Square Worklamp

part no.	description	pattern	volts	raw lumens	warranty
ECCOE93005*	square, HID extreme-duty worklamp	flood	12-24V DC @ 3.0A	1600	2

* CE rated



ECCOE91082

Halogen Oval Worklamp

part no.	description	pattern	volts	raw lumens	warranty
ECCOE91082	oval halogen worklamp	flood	12V DC @ 5.2A	1100	1
ECCOE91085	oval halogen worklamp	spot	12V DC @ 5.2A	1150	1



ECCOE91002

Halogen Round Worklamp

part no.	description	pattern	volts	raw lumens	warranty
8595	round halogen worklamp	flood	12V DC @ 4.1A	900	1
ECCOE91002	round halogen worklamp	flood	12V DC @ 5.2A	1200	1



ECCOE91005

Halogen Square Worklamp

part no.	description	pattern	volts	raw lumens	warranty
ECCOE91005	square halogen worklamp	flood	12V DC @ 4.1A	1000	1
ECCOE91025	square, compact worklamp	flood	12V DC @ 5.2A	950	1
ECCOE91099	square, compact worklamp	flood	12V DC @ 5.2A	800	1
ECCOE91026	square, compact worklamp	spot	12V DC @ 5.2A	1000	1
ECCOE91102	square, compact worklamp	spot	12V DC @ 5.2A	750	1



Scan for pricing or go to www.delcity.net/catalogpricing



ECCOE91010

Halogen Rectangle Worklamp

part no.	description	pattern	volts	raw lumens	warranty
7895	rectangle, halogen worklamp	flood	12V DC @ 4.1A	1100	1
ECCOE91064	rectangular, twin beam extreme-duty worklamp	flood	12V DC @ 9.4A	1850	1
ECCOE91088	rectangular, twin oval beam extreme-duty worklamp	flood	12V DC @ 9.4A	1750	1
ECCOE91067	rectangular, twin beam extreme-duty worklamp	spot	12V DC @ 9.4A	2300	1
ECCOE91091	rectangular, twin oval beam extreme-duty worklamp	spot	12V DC @ 9.4A	2050	1



8595

Rubber Tractor Light

All-purpose Par 36 sealed beam tractor light features a rubber-coated housing that is resistant to moisture, vibration and road shock. Light features a mounted swivel base bracket and the lamp within is comparable to a #4411 bulb. Rated for 8–14V DC.

part no.	description
8595	tractor light



7895

Rectangular Flood Lamp

The tough EPDM, impact resistant housing is ideal to be utilized as auxiliary lighting or secondary reverse light. The polycarbonate lens provides a wide dispersal pattern and the dual swivel points allow for a diverse range of lamp positions. Hardware included. Rated to 8–14V DC.

part no.	description
7895	rectangular flood lamp

NEW

ECCO® Equinox™ Square 6 LED Worklamp



ECCOEW2101 ECCOEW2101A

A universal worklamp, the Equinox™ work lamps offer the latest technology and provide the brightest light for your application. Featuring aluminum housing, polycarbonate lens, IP67 rating and a 3 year warranty. Select from white or amber illumination.

part no.	description	pattern	rating	volts	raw lumens	warranty
ECCOEW2101	Equinox™ Square 6 LED Worklamp	flood	IP67	12-36V DC @ 1.8 A	1750	3
ECCOEW2101A	Equinox™ Square 6 LED Amber Worklamp	flood	IP67	12-36V DC @ 1.8 A	1750	3



NEW

ECCO® Equinox Square 8 LED Worklamp



ECCOEW2102

With a modern housing shape and exclusive ECCO grille recessed in the lens, Equinox is a distinctive universal work lamp that shines brightly in any work environment. The EW2102 model also features the Lo-GLO™, an illuminated ECCO logo that provides both a modern look and offers additional safety as an obstruction marker light. Featuring aluminum housing, IP67 protection rating and a 3 year warranty, the EW2102 has the added benefits of a UV hard coated lens and a Gore® vent for superior environmental protection.

part no.	description	pattern	rating	volts	raw lumens	warranty
ECCOEW2102	Equinox™ Square LED Worklamp	flood	IP67	12-36V DC @ 2.8 A	2100	3



NEW

ECCO® Rubber Round 6 LED Flood Light

The E92013 Series work lamp combines the latest long-life LED technology with the highly popular PAR36 rubber housing. Ideal for replacing outdated and under performing halogen models with a modern alternative to provide better work area illumination.

part no.	description	pattern	volts	raw lumens	warranty
ECCOE92013	Round Rubber PAR36 6 LED	Flood Beam	12-24V DC @ 0.9 A	650	1



Scan for pricing or go to www.delcity.net/catalogpricing

**Halogen Flood Lamps**

Illuminate almost any area with one of these sturdy halogen lamps. Free form lens refractor technology, creates 30% more illumination than competitive models, and a simple-to-remove lens cover allows easy access to replace the 55W, H3 bulb. The housing is manufactured from a UV heat stabilized plastic and the unique cable sealing system reduces harmful debris from getting inside. A dual swivel mounting bracket allows for multiple mounting positions and all chrome-plated stainless steel mounting hardware is included. Rated to 12V DC.

part no.	description
7490	rectangle halogen lamp, white
15000001	flush mount, rectangle halogen lamp, white
7495	rectangle halogen lamp, black

**LED Round Sealed Work Lamp**

This heavy-duty lamp is designed to endure the roughest terrains. It is manufactured with a powder-coated aluminum housing and polycarbonate lens. The 6 powerful LEDs provide a total of 280 lumens, 3,900 candles, with a minimal 1.24A draw.

part no.	description
7995	LED, crystal, 6 diode

**Marinco® Wireless Controlled Spotlight**

Marinco® spotlights are the most versatile and durable spotlights on the market. The housing features fully enclosed tilt function, double O-Ring sealing, UV resistant ASA polycarbonate construction and an IP56 weatherproof rating. Smart, wireless communication between the remote and the lights allow the controls and lights to be placed just about anywhere on your boat with universal 12 or 24 volt operation in a single design. Bright 100 Watt H3 Halogen bulb and optimized reflector and lens provide a bright and consistent light pattern. 3 year warranty.

part no.	description
19012118	white spotlight, 12/24V, 100W
19012119	black spotlight, 12/24V, 100W
19012120	chrome spotlight, 12/24V, 100W

Marinco® Wireless Control

Control your Marinco® spotlight with one-touch auto sweep and S.O.S. signal. These remotes are dual speed with micro-touch pointing accuracy and are built using a tough design that withstands harsh marine environments including moisture, salt, shock and vibration. They have auto programming, no dip switches and are reverse programmable for spotlights that are mounted upside down. 3 year warranty. All spotlights include 19012123.



part no.	description
19012123	bridge mount spotlight remote
19012124	hand-held spotlight remote
19012125	bridge mount, hard wired spotlight remote

Marinco® Replacement Bulb

Bright, H3 Halogen replacement bulbs for Marinco spotlights.

part no.	description
19012121	H3 replacement bulb, 12V, 100W
19012122	H3 replacement bulb, 24V, 100W





Scan for pricing or go to www.delcity.net/catalogpricing

NEW

ECCO® Heavy Duty Square 9 LED Spotlight



ECCOEW2310 ECCOEW2311



The ECCO® EW2310 Series work lamps offer the latest technology and the very brightest light for your application. This LED model offers over 80,000 hours of maintenance free life expectancy coupled with extremely low amp draw. High intensity 3600 lumen light output makes it an ideal choice for a wide variety of arduous applications. Features 12-24V DC operation, a choice of flood or spot beams, aluminum housing and a 3 year warranty.

part no.	description	pattern	volts	raw lumens	warranty
ECCOEW2310	Heavy-duty Square 9 LED Spotlight	Spot Beam	12-24V DC @ 5.3 A	5050	3
ECCOEW2311	Heavy-duty Square 9 LED Spotlight	Flood Beam	12-24V DC @ 5.3 A	4950	3

NEW

ECCO® Rectangular 5 LED Spot Beam



ECCOEW2320



ECCOEW2321



The EW2320 Series work lamps offer the choice of spot or flood illumination and the ability to be linked together either horizontally or vertically to suit individual needs. High intensity 2150 lumen light output and IP67 intrusion protection make this an extremely robust, bright and flexible work area lighting solution.

part no.	description	pattern	volts	raw lumens	warranty
ECCOEW2320	Rectangular 5 LED	Spot Beam	12-24V DC @ 2.2 A	2400	3
ECCOEW2321	Rectangular 5 LED	Flood Beam	12-24V DC @ 2.2 A	2400	3

NEW

ECCO® Square 9 LED Flood Beam, Swivel Mount



ECCOEW2450 ECCOEW2451



The EW2450 Series work lamps offer not only the choice of spot or flood illumination, but also offer latest technology and the very brightest white light for your application. This LED model offers over 80,000 hours of maintenance free life expectancy coupled with extremely low amp draw.

part no.	description	pattern	volts	raw lumens	warranty
ECCOEW2450	Square 9 LED, Swivel Mount	Spot Beam	12-24V DC @ 2.2 A	1400	3
ECCOEW2451	Square 9 LED, Swivel Mount	Flood Beam	12-24V DC @ 2.2 A	1350	3

NEW

ECCO® Mini Rectangular 6 LED Spot Beam



ECCOEW2440



ECCOEW2441



The compact EW2440 Series work lamps offer not only the choice of spot or flood illumination, but also the latest technology and the very brightest white light for your application. This LED model offers over 80,000 hours of maintenance free life expectancy coupled with extremely low amp draw.

part no.	description	pattern	volts	raw lumens	warranty
ECCOEW2440	Mini Rectangular 6 LED	Spot Beam	12-24V DC @ 1.2 A	1150	2
ECCOEW2441	Mini Rectangular 6 LED	Flood Beam	12-24V DC @ 1.2 A	1150	2

NEW

ECCO® Heavy-duty Square 9 LED Flood Light



ECCOEW2510 ECCOEW2511



EW2510 Series heavy-duty work lamps offer the latest technology and the very brightest white light for your application. These LED models offer over 80,000 hours of maintenance free life expectancy coupled with very low amp draw. A robust housing with vibration dampening bracket and high-intensity 4550 lumen output make these work lamps the ideal choice for a wide variety of arduous applications. Features 12-24 VDC operation, IP68 protection rating, a choice of flood or spot beams, aluminum housing and a 2 year warranty.

part no.	description	pattern	volts	raw lumens	warranty
ECCOEW2510	Heavy-duty Square 9 LED Flood Light	Spot Beam	12-24V DC @ 4.8 A	5150	2
ECCOEW2511	Heavy-duty Square 9 LED Flood Light	Flood Beam	12-24V DC @ 4.8 A	5000	2

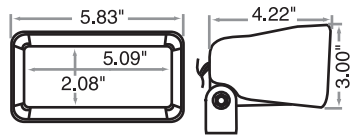
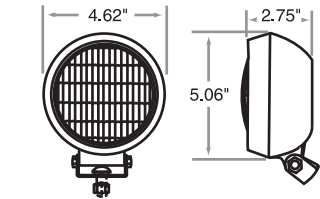
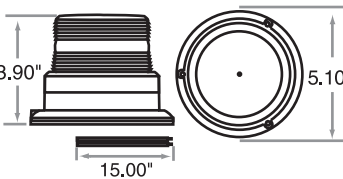
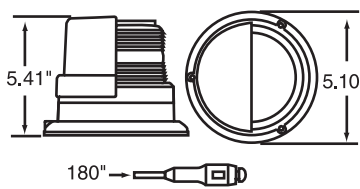
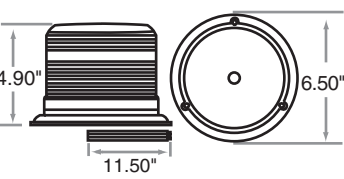
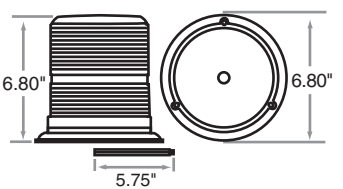
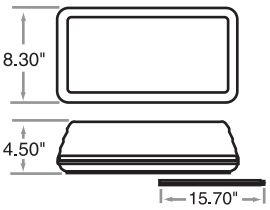
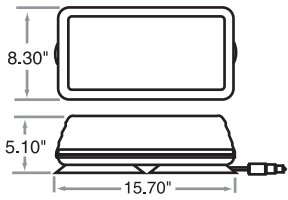
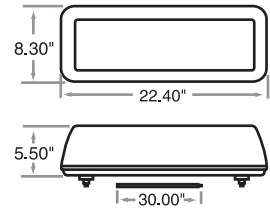
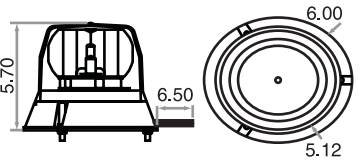
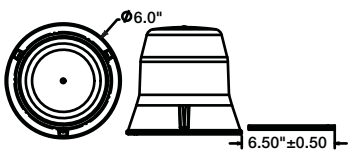
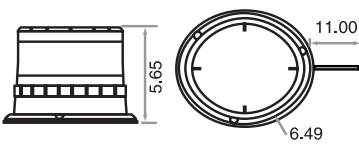
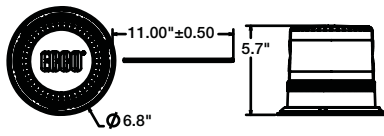
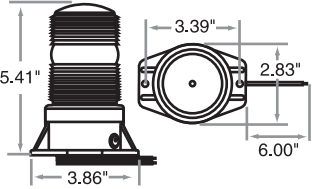
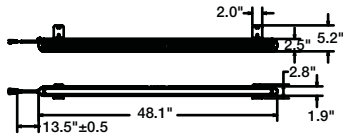
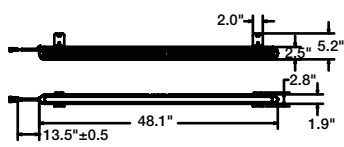
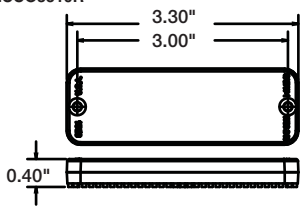
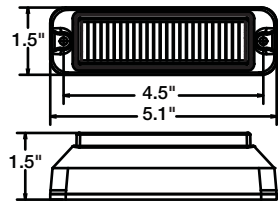
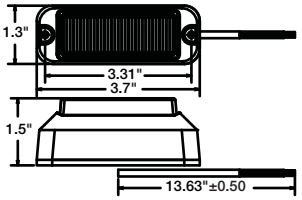
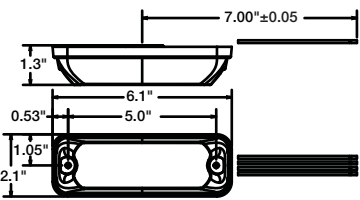
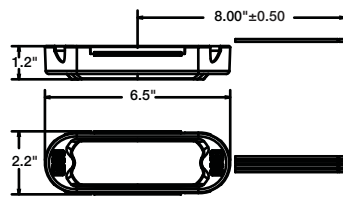

Scan for pricing or go to www.delcity.net/catalogpricing

<p>7895</p> 	<p>8595</p> 	<p>10015/ECCO7460A /ECCO7460CA/ECCO7460CC</p> 
<p>10020/ECCO7460AVM/ECCO7460CAVM/ ECCO7460CCVM</p> 	<p>10025/10030/10035DL</p> 	<p>10040</p> 
<p>10045</p> 	<p>10050</p> 	<p>10055</p> 
<p>10060</p> 	<p>10065</p> 	<p>10110</p> 
<p>10115</p> 	<p>10010DL</p> 	<p>ECCO3410LBA/ECCO3410A/</p> 
<p>ECCO3410LBA/ECCO3410A</p> 	<p>ECCO3510A/ECCO3510B/ECCO3510C/ ECCO3510R</p> 	<p>ECCO3715A /ECCO3515C</p> 
<p>ECCO3730A/ECCO3730C/ECCO3735A/ ECCO3735C</p> 	<p>ECCO3811A/ECCO3811B/ECCO3811C/ ECCO3811R</p> 	<p>ECCO3861A/ECCO3861B/ECCO3861C/ ECCO3861R</p> 



Scan for pricing or go to www.delcity.net/catalogpricing

<p>ECCO3912A/ECCO3911A/ECCO3930A/ ECCO3910A</p>	<p>ECCO3921A/ECCO3920A</p>	<p>ECCO3945A/ECCO3945C</p>
<p>ECCO3965A/ECCO3965C</p>	<p>ECCO5280A</p>	<p>ECCO5280AMG</p>
<p>ECCO5585 Series</p>	<p>ECCOE91005</p>	<p>ECCOE91064/ECCO91064</p>
<p>ECCOE91088</p>	<p>ECCOE91025/ECCOE91099</p>	<p>ECCOE92001</p>
<p>ECCOE93005</p>	<p>ECCOEB7930A/ECCOEB7930C/ECCOEB79335A/ ECCOEB7935C</p>	<p>ECCOED0001A/ECCOED0001B/ECCOED0001C/ ECCOED0001R</p>
<p>ECCOED0002A/ECCOED0002B/ECCOED0002C/ ECCOED0002R</p>	<p>ECCOED0003A/ECCOED0003B/ECCOED0003C/ ECCOED0003R</p>	<p>ECCOED0004A/ECCOED0004B/ECCOED0004C/ ECCOED0004R</p>
<p>ECCOED0007A</p>	<p>ECCOED0010A/ECCOED0010B/ECCOED0010C/ ECCOED0010R</p>	<p>ECCOED0011A/ECCOED0011C/ECCOED0011B/ ECCOED0011R</p>



Scan for pricing or go to www.delcity.net/catalogpricing

<p>ECCOEW2101/ECCOEW2101A</p>	<p>ECCOEW2102</p>	<p>ECCOEW2300</p>
<p>ECCO6465A /ECCO6465C</p>	<p>ECCO6465AMG/ECCO6465CMG</p>	<p>ECCO7160A/ECCO7160CA/ECCO7160CC</p>
<p>ECCO7160AVM/ECCO7160CAVM / ECCO7160CCVM</p>	<p>ECCO7660A/ECCO7660CA</p>	<p>ECCO7945A/ECCO7945AC</p>
<p>ECCO7945AVM/ECCO7945CVM</p>	<p>ECCO7950A/ECCO7950C</p>	<p>ECCO7950AVM/ECCO7950CVM</p>
<p>ECCO7965A /ECCO7965C</p>	<p>ECCO7965AVM /ECCO7965CVM</p>	<p>ECCO7970A/ECCO7970C</p>
<p>ECCO7970AVM/ECCO7970CVM</p>	<p>ECCO7975A/ECCO7980A</p>	<p>ECCO9014A/ECCO9014B/ECCO9014C/ ECCO9014R</p>
<p>ECCOE91002</p>	<p>ECCOE91005</p>	<p>ECCOEW2310</p>



Scan for pricing or go to www.delcity.net/catalogpricing

<p>ECCOEW2320</p>	<p>ECCOEW2401</p>	<p>ECCOEW2411</p>
<p>ECCOEW2421</p>	<p>ECCOEW2431</p>	<p>ECCOEW2440</p>
<p>ECCOEW2450</p>	<p>ECCOEW2501</p>	<p>ECCOEW2510</p>

BACK-UP ALARMS

Fixed Sound - Back-up alarm produces a standard fixed audio beeping sound at the alarms rated decibel level.

Switchable - Back-alarm can be manually switch between the alarms rated decibel level.

Smart Alarm - Back-up alarm automatically detects ambient sound and self-adjusts to produce 5 decibels louder up to stated decibel level.

Multi-Frequency - Emits sound at multiple frequencies attenuated above 400Hz so sound is perceived to dissipate quickly.



Scan for pricing
or go to
www.delcity.net/catalogpricing



ECCO® Compact Surface Back-up Alarm



ECCO's compact, surface-mount alarm provides a low-mount warning alarm specifically designed to offer a wide range of mounting options where space is limited. It is designed with rugged durability and is protected from vibration and moisture. ECCO's unique grill design meets the requirements of SAE J994 for high-pressure washing. Temperature range -40°F to +185°F (-40°C to +85°C).

part no.	description	dB	volts	SAE type
ECCO210	light-duty, compact fixed decibel	97	12V DC	C



9115

ECCO® Light-duty Back-up Alarms



ECCO's most compact and popular line of back-up alarms provides a cost-effective warning solution with ECCO quality and reliability. A glass-filled nylon housing with epoxy-encapsulated electronics provide exceptional durability and protection against moisture, dust and vibration. ECCO's Smart Alarm measures ambient noise and adjusts sound levels to create a volume that is safe without being annoying or contributing to noise pollution. Smart Alarms eliminate the need for constant manual adjustment and help prevent intentional alarm disconnection. These alarms feature a compact size and universal mounting bracket maximizes location options. The alarms are self-grounding and are sealed in epoxy for protection against dust, moisture and vibration. Temperature range: -40°F to +185°F (-40°C to +85°C).

part no.	description	dB	volts	SAE type
ECCO580	light-duty fixed decibel	87	12-80V DC	D
9115	light-duty fixed decibel	97	12V DC	C
ECCO520	light-duty fixed decibel	97	12-24V DC	C
ECCO585	light-duty fixed decibel	97	12-48V DC	C
ECCO530	light-duty fixed decibel	102	12-24V DC	F
9135	light-duty adjustable decibel	77-97	12-24V DC	N/A
ECCOSA950	light-duty adjustable decibel	82-102	12-24V DC	N/A



9135

ECCO® Forward Horn Alarms

ECCO offers a variety of different warning alarms for both back-up and non-back-up applications including combination alarm & lights, dual function, dual tone and selectable volume alarms. ECCO's Forward horns are specifically designed for use on SCR controlled electric vehicles or severe vibration IC vehicles.



ECCOFH577

part no.	description	dB	volts	SAE type
ECCODF532	medium-duty, fixed decibel	102	12-24V DC	F
ECCOFH575	medium-duty, forward horn, fixed decibel	107	12V DC	L
ECCOFH577	forward horn, fixed decibel	107	24-48V DC	N/A
ECCODT500	dual ton, fixed decibel	97	12-24V DC	N/A
ECCODT500FPLWC	dual ton, fixed decibel	102	12-24V DC	N/A



Scan for pricing or go to www.delcity.net/catalogpricing



ECCO5200

ECCO® Multi-Frequency Alarm

The Multi-Frequency back-up alarm provides a solution to potential noise pollution created by back-up alarms in confined or densely populated work areas. The Multi-Frequency alarm maintains a safe warning signal for those in the danger zone of backing vehicles while minimizing disturbance to work site neighbors. The Multi-Frequency alarm operates by emitting sound at multiple frequencies attenuated above 4000Hz so that the sound is perceived to dissipate more quickly than a conventional pure-tone alarm. These alarms feature universal mounting bracket maximizes location options and a lead wire. The alarms are sealed in epoxy for protection against dust, moisture and vibration. Temperature range: -40°F to +185°F (-40°C to +85°C).

part no.	description	dB	volts	SAE type
ECCOEC5050	light-duty, multi-frequency	87	12-24V DC	D
ECCO5200	light-duty, multi-frequency	97	12-24V DC	C
ECCO7020	medium-duty, multi-frequency	102	12-24V DC	B
ECCO7070	medium-duty, multi-frequency	107	12-24V DC	F



ECCO575

ECCO® Light-duty Back-up Alarm

This alarm provides a high dB(A) sound in a compact housing for use in less arduous environments where ambient noise level is high. ECCO specifically designed it to meet our quality standards, yet provide a cost-considerate product. The glass-filled nylon housing provides rugged durability and the epoxy-encapsulated circuit board protects the electronics from vibration and moisture. ECCO's unique grill design meets the requirements of SAE J994 for high-pressure washing. Universal mounting bracket maximizes location options. The alarms are reverse polarity, voltage spike and surge protected and work on positive and negative ground systems. The alarms are AMECA certified to SAE J994, Type B., e. Temperature range: -40°F to +185°F (-40°C to +85°C).

part no.	description	dB	volts	SAE type
ECCO575	light-duty, fixed decibel	107	12-24V DC	B



9110

ECCO® Medium-duty Back-up Alarms



Designed to meet all the harsh operational requirements of any fleets equipment, ECCO 600 Series alarms feature ECCO's unique reverse-mounted speaker design with unrivaled durability. Smart Alarms models measure ambient noise and adjust their sound level, creating a volume that is safe without being annoying or contributing to noise pollution. Smart Alarms eliminate the need for constant manual adjustment and help prevent intentional alarm disconnection. These alarms feature steel housing and extra heavy-duty construction for rugged applications. The alarms are reverse-mounted speaker designed to enhance sound and protect the speaker for longer life and are sealed in epoxy for protection against dust, moisture and vibration. Other features include: steam cleanable and pressure washable, voltage spike and surge protected, and reverse polarity protected. The alarms work on positive or negative ground systems. Temperature range: -40°F to +185°F (-40°C to +85°C).

part no.	description	dB	volts	SAE type
9110	medium-duty adjustable decibel	82-107	12-24V DC	N/A
9120	medium-duty decibel	107	12-36V DC	B
ECCOSA931	medium-duty, self adjusting	82-102	12-48V DC	N/A
ECCOSA980	medium-duty, self adjusting	82-102	36-80V DC	N/A



ECCO450

ECCO® Grommet Mount Heavy-Duty Back-up Alarms



The grommet mount back-up alarm helps reduce installation time by utilizing a standard 4.5" rear lighting grommet for mounting. It is epoxy sealed for protection against dust, moisture and vibration. CE, e. Temperature rating of -40°F to +185°F (-40°C to +85°C).

part no.	description	dB	volts	SAE type
ECCO450	heavy-duty fixed decibel	112	12-36V DC	A
ECCOSA940	heavy-duty self-adjusting decibel	87-112	12-24V DC	N/A

ECCO® Heavy-duty Back-up Alarms

ECCO830

Designed to meet all the harsh operational requirements of any fleets equipment, ECCO's 800 Series alarms feature ECCO's unique reverse mounted speaker design providing unrivaled durability. Smart Alarm models measure ambient noise and adjust their sound level, creating a volume that is safe without being annoying or contributing to noise pollution. Smart Alarms eliminate the need for constant manual adjustment and help prevent intentional alarm disconnection. These alarms feature steel housing and extra heavy-duty construction for rugged applications. The alarms are sealed in epoxy for protection against dust, moisture and vibration. Reverse mounted speaker enhances sound and protects the alarm from dust and moisture ingress. Temperature range: -40°F to +185°F (-40°C to +85°C).



Scan for pricing or go to www.delcity.net/catalogpricing

part no.	description	dB	volts	SAE type
ECCO830	heavy-duty fixed decibel	107	12-36V DC	B*
ECCO850	super-duty fixed decibel	112	12-36V DC	A
ECCO820	heavy-duty switchable decibel	87-107	12-36V DC	B, D
ECCO840	heavy-duty switchable decibel	97-112	12-36V DC	A, C
9140	heavy-duty switchable decibel	87-112	12-24V DC	N/A*

* no RV

ECCO® Heavy-duty Back-up Alarms

9145

The 9145 is a fixed decibel, heavy-duty back-up alarm. It is manufactured from heavy-duty, 22 gauge steel. It is sealed in epoxy to resist moisture, dust and vibration. The 9145 meets OEM design for heavy-duty construction applications and "crush" specifications. It is reverse polarity and voltage transient protected. It has a temperature rating of -40°F to +185°F (-40°C to +85°C).

part no.	description	dB	volts	SAE type
9145	super-duty fixed decibel	112	12-24V DC	A

OEM Design Back-up Alarms

ECCO876



ECCO777

OEM back-up alarms are designed to meet all the harsh operational requirements of any fleet. All alarms are manufactured from glass-filled nylon. All are sealed in epoxy to protect sensitive electronics from dust, moisture and vibration. Temperature rating of -40°F to +185°F (-40°C to +85°C).

part no.	description	dB	volts	SAE type
ECCO876	heavy-duty fixed decibel	112	12-36V DC	A
ECCO872	heavy-duty switchable decibel	97/112	12-36V DC	C, A
ECCOSA914	heavy-duty self-adjusting decibel	87-112	12-24V DC	N/A
ECCO777	heavy-duty switchable decibel	97-107-112	12-24V DC	A, B, C
ECCOSA920	heavy-duty self-adjusting decibel	97-112	12-24V DC	N/A

ECCO® Back-up Switches

9125

9130

Designed and manufactured for vehicles not equipped with back-up circuits. Item #9130 and ECCOSW30 have 360° of movement and are selectable to normally open or normally closed. Single pole, double throw (S.P.D.T.).

part no.	description
9125	light-duty back-up switch, 12 - 24V DC
9130	heavy-duty back-up switch 12-80V DC
ECCOSW30	heavy-duty back-up switch, 12-80V DC



Scan for pricing or go to www.delcity.net/catalogpricing



ECCOK7000Q

ECCO® 7 Inch LCD Quad View Color Camera System Kit

The 7" LCD high-resolution color monitor included with this system features split screen, quad view capability. It has excellent picture quality, even in low-light conditions using ECCO's standard color infrared camera. Kit includes: 1 ECCOM7000Q monitor, 1 ECCOC2000 Camera, 1 TC20 Cable. M7000Q monitor: 7.0" LCD monitor, 12-24 VDC, permanent mounting, E13, FCC, CE approved, 7.17" W x 4.88" H x 1.54" D. camera ECCOC2000: 1/4" Sony CCD color 500H x 582V pixels, 110° diagonal lens angle, IP68, E13, FCC, CE, salt-mist approved, 3.62" W x 3.19" H x 2.41" D. TC20 cable: 1.5 lbs, 20M or 65'.

part no.	description
ECCOK7000Q	7" LCD quad view color camera system kit
ECCOM7000Q	7" LCD quad view LCD color monitor for ECCOK7000Q system
ECCOC2000	color camera, 18 infrared LEDs
ECCOTC20	65' camera transmission cable, 4 pin



ECCOK7000W

ECCO® 7 Inch Weatherproof Quad View Camera System Kit

The 7" LCD high-resolution color monitor included with this system features split screen, quad view capability. It has excellent picture quality, even in low-light conditions using ECCO's standard color infrared camera. Kit includes: 1 ECCOM7000W monitor, 1 ECCOC2000 camera, 1 ECCOTC20 cable. monitor: 7.0" LCD weatherproof monitor, 12-24 VDC, permanent mounting, IP65, E13, FCC, CE approved, 7.87" W x 5.45" H x 2.99" D. camera ECCOC2000: 1/4" Sony CCD color 500H x 582V pixels, 110° diagonal lens angle, IP68, E13, FCC, CE, salt-mist approved, 3.62" W x 3.19" H x 2.41" D. ECCOTC20 cable: 1.5 lbs, 20M or 65'.

part no.	description
ECCOK7000W	7" LCD weatherproof quad view color camera system kit
ECCOM7000W	7" LCD weatherproof quad view LCD color monitor for ECCOK7000W system
ECCOC2000	color camera, 18 infrared LEDs
ECCOTC20	65' camera transmission cable, 4 pin



ECCOK7000

ECCO® 7 Inch LCD Color Camera System Kit

The 7" LCD high-resolution color monitor provides the optimal viewing area for mobile CCTV applications. It has excellent picture quality, even in low-light conditions using ECCO's standard color infrared camera. Kit includes: 1 ECCOM7000 monitor, 1 ECCOC2000 camera, 1 TC20-Cable. ECCOM7000 monitor: 7.0" LCD monitor, 12-24 VDC, permanent mounting, E13, FCC, CE approved, 7.0"W x 5.13"H x 1.16"D. camera C2000: 1/4" Sony CCD color 500H x 582V pixels, 110° diagonal lens angle, IP68, E13, FCC, CE, salt-mist approved, 3.62"W x 3.19"H x 2.41"D. TC20 cable: 1.5 lbs, 20M or 65'.

part no.	description
ECCOK7000	7" LCD color camera system kit
ECCOM7000	7" LCD color monitor for ECCOK7000 system
ECCOC2000	color camera, 18 infrared LEDs
ECCOTC20	65' camera transmission cable, 4 pin



ECCOK7000B

ECCO® 7 Inch LCD Color Camera Backup System Kit

A feature-packed 7.0" LCD high-resolution color monitor with internal controller and CMOS infrared color camera, the ECCOK7000B delivers excellent picture quality even in low-light conditions. Kit includes: 1 ECCOM7000B monitor, 1 ECCOC2013B camera, 1 ECCOTC20-4B cable. ECCOM7000B monitor: 7" LCD monitor, 12-24V, permanent mounting, FCC, CE, RoHS approved, 6.85" W x 4.49" H x 0.94" D. C2013B camera: 1/4" CMOS color NTSC 580H x 492V pixels, 120° diagonal lens angle, IP69K, FCC, CE, RoHS approved, 2.92" W x 3.01" H x 2.62" D. TC20-4B cable: 1.5 lbs, 20M or 65'.

part no.	description
ECCOK7000B	7" LCD color backup system kit
ECCOM7000B	7" monitor for ECCOK7000B system
ECCOC2013B	color camera for ECCOK7000B system
ECCOTC204B	65' camera transmission cable for ECCOK7000B system



Scan for pricing or go to www.delcity.net/catalogpricing



ECCOEC7003SVK

ECCO® 7 Inch LCD Touchscreen Color Camera System Kit

Provide optimal viewing and ease of use with the 7.0" LCD high-resolution touchscreen color monitor for mobile CCTV applications. It has excellent picture quality, even in low-light conditions using ECCO's standard color infrared camera. Anti-glare screen protector included. Kit Includes: 1 ECCOEC7003-SVM monitor, 1 ECCOEC2014-SVC camera, 1 ECCOECTC20-4SV cable. ECCOEC7003-SVM monitor: 7.0" LCD monitor, 12/24 VDC, permanent mounting, E13, FEE, CE, 7.28"W x 5.07"H x 1.06"D. EC2014-SVC camera: 1/3" Sony CCD color 500H x 580V pixels. ECTC20-4SV cable: 1.5 lbs, 20M or 65'

part no.	description
ECCOEC7003SVK	7.0" LCD touchscreen color camera system kit
ECCOEC7003SVM	7.0" touchscreen monitor for ECCOEC7003 system
ECCOEC2014SVC	color camera for ECCOEC7003SVK systems
ECCOECT204SV	65' camera transmission cable for ECCOEC7003SVK systems



ECCOEC5603SVK

ECCO® 5.6 Inch LCD Touchscreen Color Camera System

Provide optimal viewing and ease of use with the 7.0" LCD high-resolution touchscreen color monitor for mobile CCTV applications. It has excellent picture quality, even in low-light conditions using ECCO's standard color infrared camera. Anti-glare screen protector included. Kit Includes: 1 ECCOEC7003-SVM monitor, 1 ECCOEC2014-SVC camera, 1 ECCOECTC20-4SV cable. ECCOEC7003-SVM monitor: 7.0" LCD monitor, 12/24 VDC, permanent mounting, E13, FEE, CE, 7.28"W x 5.07"H x 1.06"D. EC2014-SVC camera: 1/3" Sony CCD color 500H x 580V pixels. ECTC20-4SV cable: 1.5 lbs, 20M or 65'

part no.	description
ECCOEC5603SVK	5.6" LCD touchscreen color camera system kit
ECCOEC5603SVM	5.6" touchscreen monitor for ECCOEC5603 system
ECCOEC2014SVC	color camera for ECCOEC5603SVK systems
ECCOECT204SV	65' camera transmission cable for ECCOEC5603SVK systems



Scan for pricing or go to www.delcity.net/catalogpricing



ECCOK3500

ECCO 3.5 Inch LCD Color Camera System Kit

A compact camera system that offers an ideal solution for non-commercial and light-duty applications where dashboard or cab space is limited. The flat 3.5" LCD color monitor provides a clear and easily viewable image without compromising space. Includes a suction cup bracket for temporary window or surface mounting. Kit includes: 1 ECCOM3500 monitor, 1 ECCOC2004 camera, 1 Y-Cable. ECCOM3500 monitor: 3.5" LCD monitor, 12-24 VDC, suction mounting, E13 certification, 4.03"W x 3.16"H x 1.18"D. ECCOC2004 camera: 1.4" Sony CCD color 500H x 582V pixels, 150° diagonal lens angle, IP68, E13, FCC, CE, salt-mist approved, 1.22" FL/1.06" body dia. 1.83" L. Y-cable: 5M/16', Y-harness (supplied with system), 8 pin male, 4 pin female s-video X2.

part no.	description
ECCOK3500	3.5" LCD color camera system kit
ECCOM3500	3.5" LCD color monitor for ECCOK3500 system
ECCOC2004	color camera, 0.22 LBS, lens angle 150°
ECCOTC205	65' camera transmission cable for ECCOK5000 system



ECCOK4200M

4.3 Inch LCD Color Camera Mirror System Kit

This compact camera system offers an ideal solution for non-commercial and light-duty applications where dashboard or cab space is limited. The LCD color monitor is embedded in the rear view mirror housing. Provides a clear, easily viewable image without compromising space. Kit includes: 1 ECCOM4200M monitor, 1 ECCOC2004 camera, 1 Y-Cable. ECCOM4200M monitor: 4.2" LCD, 12-24 VDC, suction mounting, E13 approved, 10.87" W x 3.58" H x 1.18" D. camera ECCOC2004: 1/4" Sony CCD color 500H x 582V pixels, 150° diagonal lens angle, IP68, E13, FCC, CE, salt-mist approved, 1.22" FL/1.06" body dia. x 1.83" L. Y-cable: 5M/16', Y-harness (supplied with system), 8 pin male, 4 pin female S-video X2.

part no.	description
ECCOK4200M	4.3" LCD color camera mirror system kit
ECCOM4200M	4.3" LCD color monitor for ECCOK4200M system
ECCOC2004	color camera, 0.22 LBS, lens angle 150°

NEW

ECCO® Wireless Modular System



ECCOEC1000-WMK

The EC1000-WMK will convert ECCO EC5603-K and EC7003-K camera systems to wireless, dramatically decreasing installation complexity and expense. Ideal for new installations or for retro-fitting where image transmission cables have been damaged.

part no.	description
ECCOEC1000-WMK	Wireless Modular System for Converting Wired to Wireless Systems

NEW

ECCO® Backup Camera System



ECCOEC5605-WK

ECCO wireless camera system utilizes ECCO's unique monitor and camera design. Comprising a feature-packed 5.6" LCD high-resolution touch screen color monitor and CMOS color infrared camera, the EC5605-WK delivers excellent picture quality even in low-light conditions. The compact monitor allows for unobtrusive installation without compromising viewable screen area. System is expandable up to 4 cameras.

part no.	description
ECCOEC5605-WK	5.6" Wireless Backup Camera System Kit, Monitor and Camera
ECCOEC5605-WM	5.6" Touch Screen Monitor for EC5605-WK System
ECCOEC2014-WC	Color Wireless Camera, 11 Infrared LEDs

ECCO® Color Camera - 9 Infrared LEDs

This dome, color camera has, audio and 9 IR LEDs that provide high definition night vision. The aluminum alloy housing provides a lightweight and corrosion resistant housing. A light sensor auto switches the camera to black and white in low light conditions. Plug: 4 pin.



part no.	description	power consumption	resolution	image	lens angle	dimensions
ECCOC2010	color camera, 9 infrared LEDs, 0.36 lbs	1.5W. mech vibration 10G	500(H) x 582(V)	1/4 Sony CCD	110°	2.68" Dia. x 1.34" L



ECCOC2002

ECCO® Color Camera - 9 Infrared LEDs

These eyeball, color camera has, audio and 9 IR LEDs that provide high definition night vision. The aluminum alloy housing provides a lightweight and corrosion resistant housing. A light sensor auto switches the camera to black and white in low light conditions.

part no.	description	power consumption	resolution	image	lens angle	dimensions
ECCOC2002	color camera, 9 Infrared LEDs, 0.47 lbs	1.5W, mech vibration 8G	500H x 582V	1/4 Sony CCD	110°	2.47" H x 3.03" W x 1.99" D



Scan for pricing or go to www.delcity.net/catalogpricing

ECCO® Color Camera - Lens Angle 150 Degrees

A compact flush or bracket mounted camera that is ideal for use where a small unobtrusive camera is required. The aluminum alloy housing provides a lightweight and corrosion resistant housing. Plug: 4 Pin.



part no.	description	power consumption	resolution	image	lens angle	dimensions
ECCOC2011	color camera, 0.44 lbs	1.2W	500(H) x 582(V)	1/4 Sony CCD	150°	1.42" Dia. x 1.77" L

Camera Transmission Cables

Replacement transmission cables for your ECCO® camera system. Offered in various lengths.



part no.	description
ECCOTC05	16' camera transmission cable, 4 pin
ECCOTC10	32' camera transmission cable, 4 pin
ECCOTC15	49' camera transmission cable, 4 pin

Transmission Adapters

These are standard transmission cables with special adapters fixed to each end. Tractor/Trailer 7 to 4 pin connector (monitor to curly = 5m/16', curly = 0.6m/2' -2.4m/8', camera to curly = 20m/65').



part no.	description
ECCOTCTT20	65' transmission adapter, 7 pin trailer - 4 pin camera
ECCOTCTT10	32' transmission adapter, 7 pin trailer - 4 pin camera

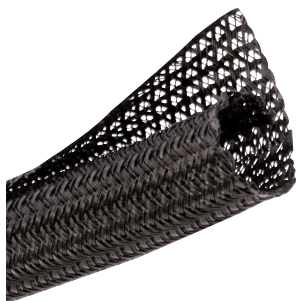

Braided Self-Wrap PET Sleeving

This sleeving simply self-closes around a group of wires. The semi-rigid braiding is stretchy and springy, allowing wires to be pulled out or new ones inserted repeatedly if necessary. It's flexible enough to bend to a tight radius without distorting or splitting open and, unlike rigid split loom, will not impair or affect the flexibility of the wires. To cut this sleeving, use a professional heat tool (#990070). The PET material is halogen free and meets UL 94V-0. It retains its shape and rigidity from -70°C to 125°C (-94°F to 257°F).

part no.	size I.D.	foot per box	lbs per box
851	1/8"	100'	1½
852	1/4"	100'	1½
854	1/2"	75'	2
855	3/4"	50'	2
856	1"	50'	3

battery cables & accessories



Scan for pricing or go to www.delcity.net/catalogpricing

Top Post Lead Battery Cables

Top quality materials are used to manufacture these cables. Unique terminal design and construction provides a positive connection for trouble-free installation and dependable service. All cables meet or exceed OEM standards for durability, strength and heat resistance. Extra heavy-duty cables used for farm, fleet and industrial purposes.



SPECIAL NOTE

If our catalog does not have the correct wire color or gauge size needed for your application, a custom battery cable can be manufactured to your specification. Minimum order quantities will apply.

6 gauge – black

part no.	length	stud size
112705DL	12"	3/8"
120705DL	20"	3/8"
124705	24"	3/8"
138705	38"	3/8"

4 gauge – red

part no.	length	stud size
115505DL	15"	3/8"
120505	20"	3/8"
124505	24"	3/8"
138505	38"	3/8"
148505	48"	3/8"
172505	72"	3/8"

Small Vehicle/Switch-to-Starter Cables

These cables are manufactured from battery cable that meets SAE J112 standards. Each terminal is tin plated and the cables termination point is covered with single wall shrink tube for added protection. Cables are ideal for solenoid switch to starter, golf carts, ATVs and other small cable applications.



6 gauge – black

part no.	length	stud size
309605	9"	5/16"
314605	14"	5/16"
412605	12"	3/8"
420605	20"	3/8"
424605	24"	3/8"

4 gauge – red

part no.	length	stud size
420405	20"	3/8"
424405	24"	3/8"

Grounding Cable

Grounding cables are manufactured with flat braided, tin-plated copper wire that is equivalent to a 4 gauge wire. Negative battery terminal and 3/8" lug are molded onto the strap for a complete cable.

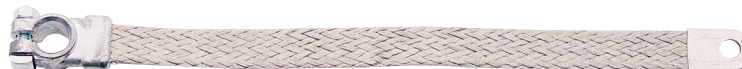

4 gauge

part no.	length	stud size
21445	14"	3/8"
219405	19"	3/8"



10½" plastic spool

Battery Cable – Type SGT

Battery cable is manufactured to SAE J-1127 specification. The Starter or Ground General Purpose Thermoplastic (SGT) cable has smooth thermoplastic polyvinyl chloride jacket to provide protection against cracking, abrasion, weather, oil and acids. Ideal use is to provide connection from battery to power or ground. Temperature rating: -40°C to 105°C (194°F to 221°F). Rated to 60V DC.

Please specify color with a 2-digit suffix; see special note box below.



Scan for pricing or go to www.delcity.net/catalogpricing

Use With
battery terminals
& lugs
PAGES 269-276



25' coil size

part no.	gauge	lbs per coil
52162	6	3
52142	4	4
52122	2	6
52112	1	8
52102	1/0	10
52002	2/0	12
52302	3/0	15
52402	4/0	20

100' spool size

part no.	gauge	lbs per spool	spool diameter
55161	6	12	10½"
55141	4	17	10½"
55121	2	27	10½"
55111	1	30	10½"
55101	1/0	39	10½"
55001	2/0	49	10½"
55301	3/0	62	10½"
55401	4/0	82	11½"

500' spool size

part no.	gauge	lbs per spool	spool diameter
55168	6	58	11½"
55148	4	83	15½"
55128	2	127	17½"
55118	1	150	17½"
55108	1/0	198	24"
55008	2/0	236	19½"
55308	3/0	316	23½"
55408	4/0	421	23½"

specification guide

gauge	stranding	nominal O.D.
6	133/0.0137	0.310"
4	133/0.0171	0.375"
2	133/0.0218	0.438"
1	133/0.0243	0.480"
1/0	133/0.0275	0.525"
2/0	133/0.0309	0.575"
3/0	361/0.0210	0.661"
4/0	361/0.0239	0.726"

Special Note

Please specify a color by applying a 2-digit suffix to the part number (corresponding to your color preference):

01 – red **05** – black

Example: when ordering a 25-ft spool of 6-Ga Battery Cable, **52162**, in red please order **5216201**.

INFORMATION

We recommend using dual wall adhesive shrink tubing for protection against corrosion. See page 41-45 for desired size and style. To choose proper size, follow these steps:

1. Choose heat shrink ratio and grade that is desired.
2. Identify desired gauge of battery cable and corresponding nominal OD from specification chart.
3. Choose the appropriate "inside diameter as supplied" heat shrink based on "inside diameter after recovery".
4. Be sure that "inside diameter after recovery" is slightly smaller than outside diameter of battery cable.

suggested ampacity for battery cable

gauge	10-ft	20-ft	30-ft	40-ft	50-ft	60-ft	80-ft	100-ft
6	200	100	50	50	50	36	36–24	24–20
4		200–150	100	100	50	50	50	36
2			200–150	150	100	100	50	50
1				200	150	100	100	50
1/0					200	150	100	100
2/0						200	150	100
3/0							200	150
4/0								200

battery cables & accessories



Scan for pricing or go to www.delcity.net/catalogpricing



990014

Battery Cleaner

Clean and protect the battery connection from corrosion. The cleaner penetrates quickly loosens, and neutralizes all acid deposits. The protective spray is lead free and fights battery corrosion to prolong the life of your battery.

part no.	description	size
990014	battery terminal cleaner	15 oz
990016	battery terminal protector	10 oz



Battery Carrier

Lift group 65 batteries from 4½" to 7½". The steel handle and adjustable arm have rubber pads riveted and glued to each end to provide superior grip. The carrier features a non-slip vinyl hand grip and can carry up to 13 lbs.

part no.	description
9900420	side grip battery carrier tool



9900433



9900431

Battery Fillers

Perfect for filling batteries, the bulb filler holds 6 ounces and is compact sized at a length of 9 inches overall. The container holds up to 2¼ quarts and features an automatic shut off and double action valve tip that prevents "after" drips.

part no.	description	size
9900433	bulb type battery filler	6 oz
9900431	battery fill container	2.125 quart



5369DL



5372

Booster Cables

These tangle free cables are a must for any dead battery situation. They are manufactured from extremely flexible bonded cable and will remain flexible in most extreme climates. The cable clamps are color-coded for easy identification and work with top and side post terminals.

part no.	length (ft)	gauge	insul. color	clamp (amps)	package
5367	12	4	white/black	400	retail box
5368	16	4	white/black	400	retail box
5369DL	20	4	white/black	400	retail box
5372*	16	4	white/black	500	retail box
5378DL*	20	2	red/black	500	retail box

* Parrot style clamp

Copper Die Cast Battery Terminals

Terminals can be crimped or soldered. All size terminals can be crimped with crimping tool 990000 (refer to page 278). Includes 1/4" bolts; bolts and nuts shipped as loose pieces. Rated up to 48V DC.



Scan for pricing or go to www.delcity.net/catalogpricing

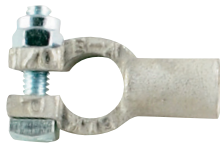

straight barrel

part no.	cable size	polarity	part no.	cable size	polarity
909105	6 ga	positive & negative	909165	2/0 ga	positive
909115	4 ga	positive & negative	909175	2/0 ga	negative
909125	2-1 ga	positive	909185	3/0 ga	positive
909135	2-1 ga	negative	909195	3/0 ga	negative
909145	1/0 ga	positive	909485	4/0 ga	positive
909155	1/0 ga	negative	909495	4/0 ga	negative



parallel (flag)

part no.	cable size	polarity	part no.	cable size	polarity
909205	1/0 ga	positive	909225	2/0 ga	positive
909215	1/0 ga	negative	909235	2/0 ga	negative

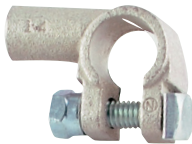

left elbow

part no.	cable size	polarity	part no.	cable size	polarity
909425	1/0 ga	positive	909445	2/0 ga	positive
909435	1/0 ga	negative	909455	2/0 ga	negative

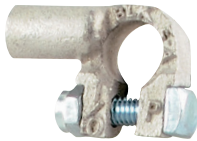

right elbow

part no.	cable size	polarity	part no.	cable size	polarity
909325	1/0 ga	positive	909345	2/0 ga	positive
909335	1/0 ga	negative	909355	2/0 ga	negative

Lead Battery Terminals

Manufactured with a lead alloy composed of antimony that ensures the terminal will have the tensile strength and hardness to meet today's heavy electrical demand. Terminals are 25-50% more dense than competitive product. Bolts (1/2") and nuts included. Rated up to 48V DC.



straight

part no.	cable size	type
901065	2-4/0 ga	positive & negative



universal

part no.	cable size	type
908885	6-1 ga	positive & negative



truck battery

part no.	cable size	type
901045	6-1 ga	positive



ordinance bolt type

part no.	stud size	type
901075	3/8"	positive
901085	3/8"	negative

battery cables & accessories



Scan for pricing or go to www.delcity.net/catalogpricing

FUSION® Battery Terminals

Fusion® battery terminals provide a more consistent quality, faster installation, less confusion and an overall reduced cost of installation process. Fusion® terminals and lugs are come loaded with pre-measured flux and solder in a solderable tin plated copper connector. Simply clamp connector into a vise, strip cable to expose 7/8" of wire, heat and insert, and cool to solidify.



straight barrel

part no.	cable size	polarity	part no.	cable size	polarity
91940164	6 & 4 ga	positive	91940264	6 & 4 ga	negative
91940121	2 & 1 ga	positive	91940221	2 & 1 ga	negative
91940110	1/0 ga	positive	91940210	1/0 ga	negative
91940120	2/0 ga	positive	91940220	2/0 ga	negative
91940130	3/0 ga	positive	91940230	3/0 ga	negative
91940140	4/0 ga	positive	91940240	4/0 ga	negative



left elbow

part no.	cable size	polarity	part no.	cable size	polarity
-	6 & 4 ga	Positive	-	6 & 4 ga	Negative
91944121	2 & 1 ga	Positive	91944221	2 & 1 ga	Negative
91944110	1/0 ga	Positive	91944210	1/0 ga	Negative
91944120	2/0 ga	Positive	91944220	2/0 ga	Negative
91944130	3/0 ga	Positive	91944230	3/0 ga	Negative
91944140	4/0 ga	Positive	91944240	4/0 ga	Negative



right elbow

part no.	cable size	polarity	part no.	cable size	polarity
-	6 & 4 ga	Positive	-	6 & 4 ga	Negative
91945121	2 & 1 ga	Positive	91945221	2 & 1 ga	Negative
91945110	1/0 ga	Positive	91945210	1/0 ga	Negative
91945120	2/0 ga	Positive	91945220	2/0 ga	Negative
91945130	3/0 ga	Positive	91945230	3/0 ga	Negative
91945140	4/0 ga	Positive	91945240	4/0 ga	Negative



flag

part no.	cable size	polarity	part no.	cable size	polarity
-	6 & 4 ga	Positive	-	6 & 4 ga	Negative
91941121	2 & 1 ga	Positive	91941221	2 & 1 ga	Negative
91941110	1/0 ga	Positive	91941210	1/0 ga	Negative
91941120	2/0 ga	Positive	91941220	2/0 ga	Negative
91941130	3/0 ga	Positive	91941230	3/0 ga	Negative
91941140	4/0 ga	Positive	91941240	4/0 ga	Negative

Use With
shrink tube

PAGES 41-44





Scan for pricing or go to www.delcity.net/catalogpricing

Brass Battery Terminals

Brass construction provides corrosion protection and low resistance connections. Using brass battery terminals, heat shrink, and lugs on existing or new wire allows you to specially configure any battery cable. 11/2" bolts and nuts shipped as loose pieces.



straight barrel

part no.	cable size	type
906115	6-4 ga	positive & negative lead plated
906095	2-1 ga	positive & negative lead plated
906085	1/0 ga	positive & negative lead plated
906105	2/0-3/0 ga	positive & negative lead plated



strap

part no.	cable size	type
906065	4-2 ga	positive & negative lead plated



split barrel

part no.	cable size	type
906055DL	1-1/0 ga	positive & negative lead plated
906705	2/0-3/0 ga	positive lead plated
906715	2/0-3/0 ga	negative lead plated



wingnut (for all wire sizes)

part no.	wing stud dimension	type
901275	3/8"	positive lead plated
901285	5/16"	negative lead plated

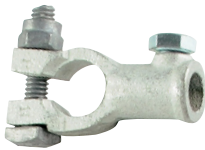

solderless

part no.	cable size	type
901035	6-1 ga	positive & negative tin plated

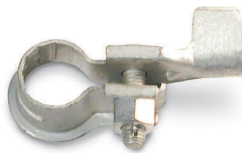

Lead-free OEM Style Battery Terminals

Ideal replacement for light and medium duty. Zinc-plated copper alloy. Ribbed barrel for added wire gripping. Rated up to 48V DC.

part no.	description	type
909065	8-6 ga	positive
909075	8-6 ga	negative
909085	4-1 ga	positive
909095	4-1 ga	negative



Battery Direct Connect

Wire direct to the battery for less interference. Terminate up to four electronic instruments on each set of terminals. Complete with two 14-16 gauge and two 12-10 gauge quick connect terminals. Positive molded in red, negative molded in black. One piece, no screws or parts; easy to install - no tools required.

part no.	description
901055	battery direct connect

battery cables & accessories



Scan for pricing or go to www.delcity.net/catalogpricing



603



604



605



909685

Battery Bolts and Nuts

Replace your worn-out bolts or stud connection points with these zinc-plated styles. They provide a strong and secure installation point for your next installation job. Use 605 to extend positive post to provide additional power hook-ups. Rated up to 48V DC.

part no.	description	size
603DL	shoulder head nut	5/16" x #18 x 1 1/2"
604DL	side terminal bolt	3/8" x #16 x 1"
605DL	side terminal accessory power connection	3/8" x #16 x 1"
909685	battery terminal fastener for 3/8" - 16NPT stud type mount batteries	3/8" x #16 x 1"



9900404



9900406



9900412

Battery Tools

The perfect tools for battery installation and removal. These tools can be purchased either individually or together in a kit and convenient carrying pouch. Ratcheting tools in various lengths for loosening or tightening side terminals, pliers, removal tools and cleaners.

part no.	size	description	handle length
9900400	5/16"	ratcheting side terminal wrench	4"
9900402	5/16"	ratcheting side terminal wrench	8"
9900404	-	battery terminal removal tool	-
9900406	10 mm	ratcheting side terminal wrench	4"
9900408	-	battery terminal spreader pliers	-
9900410	-	angle nose battery pliers	-
9900412	-	battery maintenance kit with pouch	-



906845

Standard Bare Copper Lugs

These lugs are perfect for large gauge applications for power draw or grounding. They are versatile enough to either crimp or solder to wire. They feature a burr-free appearance for an aesthetically pleasing finish. Amp ratings are suggested and are dependent on length of run of wire. See page 278 for crimp tools and pages 39-41 for shrink tube. Rated up to 48V DC.

1/4" stud (.250) clearance (.336)

part no.	amp	cable size
906515	70	6/4 ga
906525	90	2 ga
906535	125	1 ga
906545	150	1/0 ga
906555	175	2/0 ga

3/8" stud (.375) clearance (.405)

part no.	amp	cable size
906815	70	6/4 ga
906825	90	2 ga
906835	125	1 ga
906845	150	1/0 ga
906855	175	2/0 ga
906865	225	3/0 ga
906875	225	4/0 ga

5/16" stud (.313) clearance (.336)

part no.	amp	cable size
906615	70	6/4 ga
906625	90	2 ga
906635	125	1 ga
906645	150	1/0 ga
906655	175	2/0 ga
906665	225	3/0 ga
906675	225	4/0 ga

1/2" stud (.500) clearance (.525)

part no.	amp	cable size
907825	90	2 ga
907835	125	1 ga
907845	150	1/0 ga
907855	175	2/0 ga
907865	225	3/0 ga
907875	225	4/0 ga

Use With crimping tools PAGE 278



Tinned Plated Copper Lugs



Help stop corrosion before it starts. These tin plated copper lugs reduce corrosion caused by harsh environments. They can be installed by crimping or soldering. All lugs are burr-free to provide a professional look. See page 278 for crimp tools and pages 39–41 for shrink tube. Rated up to 600V.



Scan for pricing or go to www.delcity.net/catalogpricing

1/4" stud (.250) clearance (.336)

part no.	amp	cable size
916505	40	6 ga
916515	70	4 ga
916525	90	2 ga
916535	125	1 ga
916545	150	1/0 ga
916555	175	2/0 ga

3/8" stud (.375) clearance (.405)

part no.	amp	cable size
916805	40	6 ga
916815	70	4 ga
916825	90	2 ga
916835	125	1 ga
916845	150	1/0 ga
916855	175	2/0 ga
916865	225	3/0 ga
916875	225	4/0 ga

5/16" stud (.313) clearance (.336)

part no.	amp	cable size
916605	40	6 ga
916615	70	4 ga
916625	90	2 ga
916635	125	1 ga
916645	150	1/0 ga
916655	175	2/0 ga
916665	225	3/0 ga
916675	225	4/0 ga

1/2" stud (.500) clearance (.336)

part no.	amp	cable size
918815	70	4 ga
918825	90	2 ga
918835	125	1 ga
918845	150	1/0 ga
918855	175	2/0 ga
918865	225	3/0 ga
918875	225	4/0 ga

FUSION® Copper Lugs– Standard



Fusion copper lugs provide for a more consistent quality, faster application, less confusion, and overall less costly process. Fusion terminals and lugs are pre-measured and loaded with correctly metered flux and solder in a solderable tin plated copper connector. Simply clamp connector into a vise, strip cable to expose 7/8" of wire, heat, insert, and cool to solidify. Heat shrink recommended to provide additional corrosion resistance.

1/4" stud

part no.	cable size
-	6 & 4 ga
91912114	2 & 1 ga
91911014	1/0 ga
91912014	2/0 ga
91913014	3/0 ga
91914014	4/0 ga

5/16" stud

part no.	cable size
-	6 & 4 ga
91912156	2 & 1 ga
91911056	1/0 ga
91912056	2/0 ga
91913056	3/0 ga
91914056	4/0 ga

3/8" stud

part no.	cable size
-	6 & 4 ga
91912138	2 & 1 ga
91911038	1/0 ga
91912038	2/0 ga
91913038	3/0 ga
91914038	4/0 ga

1/2" stud

part no.	cable size
-	6 & 4 ga
91912112	2 & 1 ga
91911012	1/0 ga
91912012	2/0 ga
91913012	3/0 ga
91914012	4/0 ga

battery cables & accessories



Scan for pricing or go to www.delcity.net/catalogpricing



Heavy-duty Copper Lugs

A heavy-duty, tinned copper lug that delivers maximum voltage when needed. Crimp with 990000 (4-4/0 gauge) or 990005 (6-1 gauge) crimping tools only, refer to page 278. Length: 23/16". Rated to 600V AC.

5/16" stud (.313) clearance (.336)

part no.	cable size	color code
907315	4 ga	gray
907325	2 ga	green
907335	1 ga	pink

3/8" stud (.375) clearance (.405)

part no.	cable size	color code
907415	4 ga	gray
907425	2 ga	green
907435	1 ga	pink
907445	1/0 ga	black
907455	2/0 ga	orange
907465	3/0 ga	purple
907475	4/0 ga	yellow

1/2" stud (.500) clearance (.525)

part no.	cable size	color code
907535	1 ga	pink
907545	1/0 ga	black
907555	2/0 ga	orange
907565	3/0 ga	purple
907575	4/0 ga	yellow

Use With shrink tube PAGES 41-44



FUSION® Copper Lugs– Heavy Wall

Fusion heavy wall copper lugs provide for a more consistent quality, faster application, less confusion and overall, a less costly process. Fusion terminals and lugs are pre-measured and loaded with correctly metered flux and solder in a solderable tin plated copper connector. Simply clamp connector into a vise, strip cable to expose 7/8" of wire, heat and insert, and cool to solidify. Heat shrink recommended to provide additional corrosion resistance.



3/8" stud

part no.	cable size
91926438	6 & 4 ga
91922138	2 & 1 ga
91921038	1/0 ga
91922038	2/0 ga
91923038	3/0 ga
91924038	4/0 ga

1/2" stud

part no.	cable size
91926412	6 & 4 ga
91922112	2 & 1 ga
91921012	1/0 ga
91922012	2/0 ga
91923012	3/0 ga
91924012	4/0 ga

Anti-rotational Copper Crimp Lugs

Designed for top post and side mount batteries. Stackable for multiple battery hook-ups. Stacked terminals can lock at 24 different positions for easier cable routing. 36 "teeth" bite into the metal so the terminal will not rotate. Terminals of different gauge sizes will easily stack and lock to each other. Lugs crimp with 990000 (all sizes) or 990005 crimping tools (refer to page 278).



3/8" stud size

part no.	cable size	color code	part no.	cable size	color code
919005	6 ga	gray	919045	1/0 ga	black
919015	4 ga	gray	919055	2/0 ga	orange
919025	2 ga	green	919065	3/0 ga	purple



Copper Compression Lugs

These tin-plated compression lugs are manufactured from copper material to provide maximum current flow. They feature a viewing area to ensure that the wire is properly seated into the terminal. The color-coding of the barrel ensures that they are used with the proper gauge size. Sized for class B&C AWG cable. To accommodate FLEX wire, increase lug size to next larger size. Use 990000 and 990005 crimp tools (refer to page 278). Rated up to 600V AC.

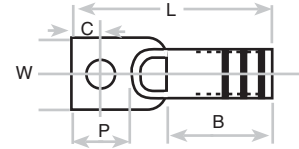

Scan for pricing or go to www.delcity.net/catalogpricing



Use With crimping tool PAGE 278

part no.	cable size	FLEX	stud size	color code	barrel I.D.	dimensions in inches				
						W	L	C	P	B
917615	8	8	1/4"	red	.179	.486	1.375	.320	.680	.500
917635	6	—	1/4"	blue	.203	.411	1.375	.320	.680	.500
917645	6	—	5/16"	blue	.203	.532	1.570	.352	.875	.500
917655	6	—	3/8"	blue	.203	.593	1.570	.414	.875	.500
917675	4	6	1/4"	gray	.250	.486	1.414	.320	.680	.500
917685	4	6	5/16"	gray	.250	.486	1.609	.352	.875	.500
917695	4	6	3/8"	gray	.250	.593	1.609	.414	.875	.500
917705	2	—	1/4"	brown	.312	.599	1.591	.320	.680	.625
917715	2	—	5/16"	brown	.312	.599	1.786	.352	.875	.625
917725	2	—	3/8"	brown	.312	.599	1.786	.414	.875	.625
917735	1	2	1/4"	green	.359	.673	1.830	.320	.875	.625
917745	1	2	5/16"	green	.359	.673	1.830	.352	.875	.625
917755	1	2	3/8"	green	.359	.673	1.830	.414	.875	.625
917765	1/0	1	1/4"	pink	.390	.738	1.981	.320	.875	.750
917775	1/0	1	5/16"	pink	.390	.738	1.981	.352	.875	.750
917785	1/0	1	3/8"	pink	.390	.738	1.981	.414	.875	.750
917805	2/0	1/0	1/4"	black	.437	.811	2.021	.320	.875	.750
917825	2/0	1/0	3/8"	black	.437	.811	2.021	.414	.875	.750
917835	2/0	1/0	1/2"	black	.437	.811	2.396	.546	1.250	.750
917855	3/0	2/0	1/4"	orange	.484	.885	2.064	.320	.875	.750
917860	3/0	2/0	3/8"	orange	.484	.885	2.064	.414	.875	.750
917865	3/0	2/0	1/2"	orange	.484	.885	2.439	.546	1.250	.750
917905	4/0	3/0	3/8"	purple	.547	0.999	2.241	.414	.875	.875
917915	4/0	3/0	1/2"	purple	.547	0.999	2.616	.546	1.250	.875



Heavy Die Cast Copper Crimp Lugs

Cast copper alloy provides a thicker and stronger connection. Ideal for large volume users. Lugs crimp with 990000 (all sizes) or 990005 (6–1 gauge only); refer to page 278.

3/8" stud size

part no.	cable size	color code	part no.	cable size	color code
909705	6 ga	gray	909745	1/0 ga	black
909715	4 ga	gray	909755	2/0 ga	orange
909725	2 ga	green	909765	3/0 ga	purple
909735	1 ga	pink	909775	4/0 ga	yellow

1/2" stud size

part no.	cable size	color code	part no.	cable size	color code
909815	4 ga	gray	909855	2/0 ga	orange
909825	2 ga	green	909865	3/0 ga	purple
909835	1 ga	pink	909875	4/0 ga	yellow
909845	1/0 ga	black			

Use With solder slugs PAGE 279



battery cables & accessories



Scan for pricing or go to www.delcity.net/catalogpricing



Anti-rotational Copper In-Line Terminals

100% cast copper alloy in-line terminal. Machine finished. Use 990000 crimp tool to terminate (see page 278).

3/8" stud size

part no.	cable size	color code
909035	1/0 ga	black
909045	2/0 ga	orange
909055	3/0 ga	purple

Use With
battery cable
PAGE 21



Butt Connectors

Use for standard cable crimp connectors. Manufactured from copper alloy with tin plating. Use crimp tool 990000 for a secure mechanical crimp (page 278).

part no.	gauge	style	stock	pkg qty
224005	8	brazed barrel	.050	25
225005	6	brazed barrel	.050	25
226005	4	brazed barrel	.075	25
227005	2	solid barrel	.075	10
211005	1	solid barrel	.030	10
212005	1/0	solid barrel	.030	10
213005	2/0	solid barrel	.038	10
214005	3/0	solid barrel	.050	10



FUSION® Butt Splices

Fusion heavy wall copper lugs provide for a more consistent quality, faster application, less confusion and overall, a less costly process. Fusion terminals and lugs are pre-measured and loaded with correctly metered flux and solder in a solderable tin plated copper connector. Simply clamp connector into a vise, strip cable to expose 7/8" of wire, heat and insert, and cool to solidify. Heat shrink recommended to provide additional corrosion resistance.

part no.	cable size
91910100	1/0 ga
91910200	2/0 ga
91910300	3/0 ga
91910400	4/0 ga

Copper Compression Lugs

Copper conductors only. Compression splices are made from seamless copper tubing for maximum current flow. Tin-plated with a wire stop to ensure proper cable insertion. Color coded for home building to visually designate correct cable size. Sized for class B&C AWG cable. To accommodate FLEX wire, increase lug size to next larger size. Use 990000 and 990005 tools to crimp (refer to page 278). Rated up to 600V AC.



part no.	cable size	FLEX	color code	barrel I.D.	length
237105	8	8	red	.179	1.125
237205	6	—	blue	.203	1.750
237305	4	6	gray	.250	1.750
237405	2	—	brown	.312	1.875
237505	1	2	green	.359	1.875
237060	1/0	1	pink	.390	1.875
237070	2/0	1/0	black	.437	2.000
237080	3/0	2/0	orange	.484	2.125
237090	4/0	3/0	purple	.547	2.125

Insulators

Battery terminal insulators provide added protection against corrosion and harmful chemicals on battery and alternator cables. Improves appearance and provides prolonged cable life.



Scan for pricing or go to www.delcity.net/catalogpricing

straight insulators



part no.	gauge	color
901645	8-6	red
901655	8-6	black
901715	1/0	red
901725	1/0	black
901735	2/0	red
901745	2/0	black

marine insulators



part no.	gauge	color
901555	6	red
901565	6	black
901575	3/0	red
901585	3/0	black

5/8" stud terminal insulators



part no.	gauge	color
901915	2-2/0	red
901925	2-2/0	black
901935	2/0-3/0	red
901945	2/0-3/0	black

testing clip insulators



part no.	amp	color
148001	25 amp	red
148005	25 amp	black

alligator clip insulators



part no.	description
145501	red, insulator only for alligator clip
145505	black, insulator only for alligator clip

Testing Clips



These steel clips are designed specifically for battery and testing equipment applications in various sizes and ratings from 10 to 50 amps.

part no.	description	style	amp
1475	2" long, 7/16" jaw spread	universal	10
148511	2 ²⁷ / ₃₂ " long, 3/4" jaw spread	positive	25
148515	2 ²⁷ / ₃₂ " long, 3/4" jaw spread	negative	25
149511	4" long, 1" jaw spread	positive	50
149515	4" long, 1" jaw spread	negative	50

battery cables & accessories



Scan for pricing or go to www.delcity.net/catalogpricing



Crimping Tool

A heavy-duty tool for crimping solderless connectors 8–4/0 gauge (standard copper lug). Can be used with either a hammer or a vice. Spring loaded lever.

part no.	description	crimps gauges
990015	hammer/vice crimper	8-4/0
NEW 990017	impact wrench/ratchet crimper	8-4/0



Junior Crimping Tool

Designed for 8–1/0 gauge die cast copper battery terminals and heavy wall copper lugs. Adjustable crimp dies are permanently attached. Features 15" insulated handles.



part no.	description	crimps gauges
990005	junior crimping tool	8–1/0 ga
8000047	replacement kit	–



Die Cast Terminal Crimping Tool

Designed for all die cast copper battery terminals or lugs. Crimps 6–4/0 gauge. This tool has 26" insulated red handles and a lock button for rotating dies. A chart for selecting the correct die setting is included.



part no.	description	crimps gauges
990000	die cast terminal crimping tool	6–4/0 ga
8000020	replacement die	–



Heavy-duty Crimper

Can be used to crimp battery terminals sizes 4–4/0 gauge and copper lugs 6–4/0 gauge. The permanently attached crimp head adjusts to the correct size and compresses the lug creating a "V-shaped" crimp. This tool has 20" handles with rubber grips and has an adjustment chart located on the front and back identifying the correct head height for crimping.

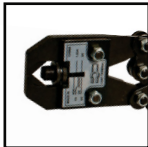

part no.	description
990001	heavy duty v-style crimping tool



Die Cast Terminal Crimping Tool

Designed exclusively for standard copper lugs, 6–4/0 gauge. Features 14" handles and is 18" in length. Includes 3 replaceable crimp dies.



INFORMATION

Die A – 6–4 gauge	Die C – 1–2 gauge
Die B – 1/0–2/0 gauge	w/o die insert– 3/0–4/0 gauge

part no.	description	crimps gauges
990065	die cast terminal crimping tool	4/0–6 ga



Battery Terminal Solder Slugs

A fast and economical method for attaching a battery terminal to a cable. Rough sealed connection for optimum performance. Slugs are color-coded for gauge to industry standards.



Scan for pricing or go to www.delcity.net/catalogpricing

INFORMATION

HOW TO USE:

1. Strip cable so the exposed copper reaches the battery terminal bottom.
2. Apply several drops of flux to the exposed copper where the battery cable has been stripped back.
3. Place the proper size slug in the battery terminal & secure terminal in vice.
4. Heat the base of the battery terminal with slug inside using a propane torch or similar tool. As the battery terminal is heated, apply gentle downward pressure on the cable. Allow time for the connection to cool.
5. Protective clothing and eye wear should be worn at all times.

part no.	slug size	color	part no.	slug size	color
900905	4 ga	gray	900945	2/0 ga	orange
900915	2 ga	green	900955	3/0 ga	purple
900925	1 ga	pink	900965	4/0 ga	yellow
900935	1/0 ga	black			



Liquid Flux

Flux removes oxidation in the copper and solder to assist the metals in their bonding process. Use one drop of liquid flux on the stripped copper wire to assist in your connection. Large cable sizes will require a few additional drops.

part no.	description
8920	liquid flux, 2 oz no clean



Solder Bar

This bar is ideal for larger soldering projects. The most common applications are for battery and welding cable terminal connections.

part no.	tin/lead	weight (lb.)	length
8915	60/40	1	12"



"44" Rosin Core Solder

Offers excellent wetting action and the flux is completely non-corrosive. Flux is electrically non-conductive. Excellent for electrical/electronic work. Qualified products listed under specification QQ-S-571 Type Wrap.

part no.	tin/lead	unit spool (lb.)	diameter	gauge
8900	60/40	1	.025"	25
8901	60/40	1	.031"	21
8902	60/40	1	.062"	16
8903	63/37	1	.031"	21
8904	63/37	1	.062"	16
8905	60/40	1	.093"	13
8906	40/60	1	.093"	13

battery cables & accessories

Dual Power Cable Links™

Available in 50, 175 and 350 amp ratings for use to 600 volts continuous AC or DC operation. Mechanical keys molded into connectors of the same color only will mate. Different color housings may be selected to identify other voltages, thus preventing the mismatching of the power supply to the electrical output. The single piece housing and modular construction provide industrial quality and durability with minimum inventory. Spring-loaded, silver plated, contoured contacts have a self-wiping cleaning action which ensures greater conductivity and longer life. Housing does not include connector; pieces are sold separately.



Scan for pricing or go to www.delcity.net/catalogpricing



INFORMATION

Two (2) housings (same color) and four (4) contacts required for complete connection.

50 amp housing

part no.	description	housing color
5632	housing with spring	black
5633	housing with spring	gray
5634	housing with spring	red
905050	insulator	red

175 amp housing

part no.	description	housing color
5635	housing with spring	gray
5636	housing with spring	blue
5637	housing with spring	yellow
5638	housing with spring	red
905175	insulator	red

350 amp housing

part no.	description	housing color
5639	housing with spring	gray
5640	housing with spring	blue
5641	housing with spring	red
5642	housing with spring	yellow
905350	insulator	red

50 amp connector

part no.	wire size
5614	10/12 ga
5615	8 ga
5613DL	6 ga

175 amp connector

part no.	wire size
5628	4 ga
5627	2 ga
5626	1/0 ga

350 amp connector

part no.	wire size
5643	2/0 ga
5644	3/0 ga
5645	4/0 ga

Use With

crimper
PAGE 278



ASSEMBLY INSTRUCTIONS

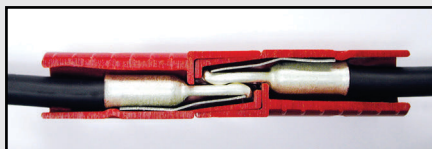

TABLE A

connector series	wire strip length (in)
50	9/16"
175	1 1/8"
350	1 3/8"

Two Dual Power Cable Links™ with single-piece housings. For all models: 50, 175 and 350 amps.

For installation in accordance with national and local electrical codes.

Assemble contacts to the cables according to the equipment manufacturer's assembly instructions. The following instructions are supplied as a reference.

- Strip cable to dimensions in Table A.
- Crimp or solder connector to cable. Note: Soldering recommended for cables with solid or minimal conductor stranding (ex. THHN type wire).
- Observing proper polarity, place connector in housing with notched side of tongue next to spring.
- Push connector and cable into housing until connector tang snaps over end of spring; tug slightly to make sure connector is locked into place.

battery cables & accessories



Scan for pricing or go to www.delcity.net/catalogpricing



Heavy Spring 500 Amp Battery Clamp – Parrot Type

These zinc plated steel, PE coated handle battery cable clamps are ideal for replacement of a worn or damaged clamp on your battery booster cables, or they can be used to create your own battery booster cables. Cable installs with attached bolt and open barrel terminal and is rated up to 500 amps.

part no.	description	packaged
142501	red handled battery clamp	bulk
142505	black handled battery clamp	bulk
1426	battery cable clamps	2/bag



Standard Spring 500 Amp Battery Clamp – EZ Reach Type

These copper coated steel, PVC coated handle battery cable clamps are ideal for replacement of a worn or damaged clamp on your battery booster cables, or they can be used to create your own battery booster cables. Cable installs directly to the open barrel terminal clamp head and is rated up to 500 amps.

part no.	description	packaged
1523	vinyl coated battery clamps	2/bag



Pigmy Clips

These copper plated, PVC insulated handle battery clips are ideal for replacement of a worn or damaged clamp on your tester or battery charger. Wire installs into open barrel type handle and is covered by the insulator. Each clamp is 3" long with a 1-1/8" jaw spread and is rated up to 50 amps.

part no.	description	packaged
144501	red, pigmy clip	bulk
144505	black, pigmy clip	bulk
1443	red & black pigmy clips	2/bag



Alligator Clips

These steel clips can be used in home, auto or work shop applications. Clamp is 1 15/16" long with a 1/2" jaw spread and can be used with insulators. Each is rated up to 10 amps.

part no.	description	packaged
1465	alligator clip	bulk
1463	alligator clips	2/bag
145501	red, insulator	bulk
145505	black, insulator	bulk



Testing Clips

These steel clips are designed specifically for battery and testing equipment applications in various sizes and ratings from 10 to 50 amps.

part no.	description	style	amp
1475	2" long, 7/16" jaw spread	universal	10
148511	2 27/32" long, 3/4" jaw spread	positive	25
148515	2 27/32" long, 3/4" jaw spread	negative	25
149511	4" long, 1" jaw spread	positive	50
149515	4" long, 1" jaw spread	negative	50



Battery Box and Relocation Kit

Battery relocation kits contain all of the needed components to help you to relocate your custom or collector car battery from the engine compartment to the trunk or rear area of the vehicle. Used for automotive restoration, marine and heavy machinery. The UV protected battery box has a universal size, fitting most traditional battery group sizes and types. Kit comes with a 30' positive (red) and a 3' negative (black) 2 gauge battery cable with top post connector, a plastic battery box that is adjustable for multiple battery group sizes, and mounting hardware. Box meets US Coast Guard regulations 183, 420, & ABYCE 10.7. Rated to -30°F (-34°C).

part no.	description
9900437	battery box relocation kit
9900439	battery box

battery cables & accessories



Scan for pricing or go to www.delcity.net/catalogpricing



Picture may vary from actual product. Visit delcity.net

Battery Jump Pack

Never worry about a low or dead battery. This lightweight iStart™ fits into the small storage areas and is ready at the flip of a switch. The built-in flashlight helps illuminate dark work areas and the 22 inch, 8 gauge flexible cables can reach most batteries under the hood of the vehicle. A 12V DC power outlet allows for emergency charging or power supply of the 7 amp hour battery. The LED battery status indicator provides a quick visual on power status of the jump pack.

part no.	description
992000	battery jump pack



Picture may vary from actual product. Visit delcity.net

Battery Booster Rescue Pack™ Inverter and Compressor

Battery booster rescue packs provide the perfect solution to jump start any vehicle. These booster packs are designed with many standard features that provide "safe jumpstarting." Each unit offers 55" cables, heavy-duty clamps with LED lights to illuminate dark areas, 12 volt receptacle outlet, an internal battery status gauge and a two function lamp for work area illumination or emergency indication. Booster pack is rated for up to 400/900 cranking amps and has an added air compressor with air gauge, a 120V power inverter and a USB outlet to recharge your computer or MP3 player.

part no.	description
991060	battery jump pack



2 Amp Battery Maintainer/Charger

Store a battery indefinitely, keep it factory fresh without fear of overcharging or boiling electrolytes, or maintain and charge a battery in a stored vehicle with this 2 amp, 12V charger for 12-volt systems. Use on boats, cars, lawn tractors, motorcycles, personal watercraft, ATVs and snowmobiles to prevent dead batteries. Complete with a 4' DC output with ring terminals and a 6-ft AC cord. Reverse polarity protected. Input voltage: 100–130V AC / 50–56Hz; Output voltage: 12V. Weight: 1.5 lbs.

part no.	description
991500	2 amp battery charger



3 Amp Battery Maintainer/Charger

Store a battery indefinitely, without fear of overcharging or boiling electrolytes or use as a full-time maintenance charger to keep your 12V battery fresh and ready to go anytime. 3 amp, 12V Charger for 12-volt systems. Maintains 12V flooded or gel cell batteries rated between 5 & 250 amp hours; also can be used to maintain a charged battery up to 500 amp hours. Ideal for boats, cars, tractors, motorcycles, personal watercraft, ATVs, etc. Complete with a 6" AC cord and 4' DC output with alligator clips. Fully potted, water and vibration resistant. Input voltage: 100–130V AC / 50–60Hz; Output voltage: 12V. Weight: 1.5 lbs.

part no.	description
991505	3 amp battery charger



6 Amp Battery Charger

Waterproof, portable 6 amp 12V battery charger/maintainer. Complete with a 6" AC cord and 4' DC outputs with alligator clips. Fully potted, shockproof, water and vibration-resistant LED power indicators and overload protection. Reverse polarity protected. Input voltage: 100–130V AC / 50–60Hz; Output voltage: 12V. Weight: 4 lbs.

part no.	description
991510	6 amp battery charger



Scan for pricing or go to www.delcity.net/catalogpricing



991515



991535

Battery Charger

This on-board, solid state, 3-stage battery charger offers a single 10, 20 or 35 amp, 12V DC output to recharge your battery to its optimal level. The charger is encapsulated in an epoxy potting compound that provides superior protection against water damage and is reverse polarity protected. Full recovery time is 6 to 8 hours based on an approximate time to restore a 100 amp hour deep cycle battery at 60% discharge. Input cable is 6' long with AC receptacle attached and voltage rating is 110 to 120 volts 60Hz AC with a maximum draw of 2 amps at 115V AC. Output cables are 4' long with 3/8" ring terminals attached and rating is 10 amps at 12V DC. Charger dimensions are 5.1" x 7.75" x 2.4" and approximate weight is 6 lbs.

part no.	description
991515	10 amp battery charger
991520	20 amp battery charger
991535	35 amp battery charger



992501



992502

Battery Isolators

Battery isolators are specifically designed to efficiently utilize the energy produced by the alternator and distribute the power evenly to each battery. Isolators are connected between the alternator(s) and the batteries, and allow primary and secondary batteries to charge together but isolate each battery during operation. They utilize internal high current diodes cooled by a heat sink to manage the isolation process. These isolators are designed to be used with negative ground alternator systems and with batteries of the same voltage level. Rated for 12 to 48 volt systems.

part no.	description
992501	battery isolator – 1 alternator/2 batteries
992502	battery isolator – 2 alternator/2 batteries



Dual Battery Disconnect/Selector Switch

Allows for selection of either battery, both batteries in parallel, or complete disconnect of both batteries. The Alternator Field Disconnect (AFD) allows selection of any position, including "off" without damaging the alternator or electrical system. Three hole surface mounting. Diameter: 5.500", height: 2.625".

4-position battery selector switch

circuit				stud size	description	rating
A	B	C	D	.375		
OFF	1	BOTH	2	5408	battery selector switch	230A @ 6–36V DC 345A intermittent



Heavy-duty Battery Disconnect/Selector Switch

Allows for selection of either battery, two batteries in parallel or complete disconnect. Features Alternator Field Disconnect (AFD) allowing selection of any position, including "off", without damage to alternator or electrical system. Manufactured with a glass-filled polycarbonate case. Diameter: 5.50", height: 3.50".

4-position battery selector switch

circuit				stud size	description	rating
A	B	C	D	.625		
OFF	1	BOTH	2	5404	battery selector switch	360A @ 6–36V DC 600A intermittent

battery cables & accessories



Scan for pricing or go to www.delcity.net/catalogpricing



990010

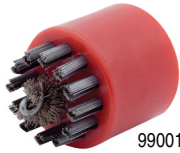

990011

Battery Terminal and Post Brush

Removes corrosion from posts and terminals. The top post brush cleans both the battery connection post and terminal. The side post cleaner is designed to clean the battery connection and has a molded housing that can be installed onto a 1/4" ratchet head.

part no.	description
990010	top post battery brush
990011	side terminal cleaner brush



Battery Protection Kit

Have all the necessary components at your fingertips to clean and protect your battery terminals. Kit includes both liquid and brush cleaner, protective spray, color-coded protective washers and hand wipes for clean-up.

For a complete listing of kit products, see page 331.

part no.	description
990012	battery protection kit



Solder Pellet & Triple Wall Shrink Tube Battery Kit – The Guardian™

Ensure you have all the necessary accessories for your next battery terminal replacement job. There are 14 different components, including color-coded solder pellets (4 AWG to 4/0 AWG), liquid flux and adhesive-lined, 3:1 shrink tube in both red and black, cut to 1.5" lengths. All items are packaged in a durable, lightweight and translucent carrying case (11" x 6-3/4" x 1-3/4"). **For a complete listing of kit contents, see page 328.**

part no.	description	pieces
652	the Guardian™ battery kit	48



Battery Hardware Kit

Replacing a corroded lug or terminal never seemed so easy! Included in this kit is 5 pcs each of 6 different standard copper lugs 6–2/0 gauge, 5 pcs each of side terminal power accessory, and 2 pcs each of universal lead and 6 different copper crimp terminals (8–4/0 gauge). All contained within a rugged, gray metal scoop box (13-5/16" x 9 1/4" x 2"). **For a complete listing of kit contents, see page 328.**

part no.	description	pieces
650	battery hardware kit	49



Solder Pellet, Terminals & Triple Wall Shrink Tube Battery Kit – The Terminalator™

This kit contains all the necessary items to repair and seal your battery cable to terminal connections. Twenty-four different items, including battery terminals in 1–2, 1/0 & 2/0 gauge and 3/8", battery terminals in 1–2, 1/0 & 2/0 gauge and 3/8" battery lugs in 4, 2–1, 1/0 & 2/0 gauge with industry standard color coding, solder pellets in 4, 1, 1/0 & 2/0 AWG with industry color coding, liquid flux and 3:1 dual wall adhesive lined black & red shrink tube ranging from 1/2", 3/4" & 1" I.D. in 1.5" cut lengths. All are packaged in a gray metal scoop box (18" x 12" x 3"). **For a complete listing of kit contents, see page 328.**

part no.	description	pieces
654	the Terminalator™ battery cable kit	89



Scan for pricing or go to www.delcity.net/catalogpricing



9901406



9903803

Flexible Head Ratchets

Flex head, locking head ratchets feature an extra long shaft to provide more leverage when operating the ratchet. The flexible head can angle 180° to tighten or loosen sockets in confined spaces. Each ratchet meets and exceeds ANSI torque requirements. Limited manufacturer LIFETIME WARRANTY on ratchet head assembly.

part no.	description	handle length
9901406	1/4" locking flex head ratchet	12"
9903803	3/8" locking flex head ratchet	18"
9901206	1/2" locking flex head ratchet	24"
9901105	1/4" and 3/8" locking flex head ratchet set	-



9901106

Extra Long Shaft Ratchet Set

A three piece set that includes one each of the 1/4", 3/8" and 1/2" ratchets, each featuring a seventy-two tooth reversible ratcheting head and extra long shaft to provide leverage for loosening or tightening bolts. Each ratchet includes a manufacturer's limited LIFETIME WARRANTY on ratchet head assembly and exceeds ANSI torque requirements.

part no.	description	handle length
9901106	1/4", 3/8" & 1/2" extra long ratchet set	12", 18", 24"



9901402



9901101

Extendable Shaft Ratchets

Features a seventy-two tooth reversible ratcheting head and provides extra leverage for loosening or tightening bolts. The unique, extendable locking shafts are manufactured of durable, heavy-duty chrome vanadium and feature a comfort grip, chemical resistant handle. The three piece set includes a 1/4", 3/8" and 1/2" ratchet packaged in a convenient high density foam tool box tray. Includes a manufacturer's limited LIFETIME WARRANTY on ratchet head assembly. Each ratchet exceeds ANSI torque requirements.

part no.	description	handle length
9901402	1/4" drive extendable ratchet	6"-8 1/4"
9903801	3/8" drive extendable ratchet	8 1/2"-12 1/2"
9901202	1/2" drive extendable ratchet	12"-17 1/4"
9901101	1/4", 3/8" & 1/2" extendable ratchet set	-



Monster Extendable Shaft Ratchet

A 3/4" reversible ratchet featuring a twenty-four tooth head and extendable shaft that provides extra leverage for loosening or tightening bolts. Its unique, extendable locking shafts are manufactured of durable, heavy-duty chrome vanadium and feature a diamond pattern knurled handle to ensure a secure grip. The 3/4" ratchet extends from 25" to 40". Includes a manufacturer's limited LIFETIME WARRANTY on ratchet head assembly and exceeds ANSI torque requirements.

part no.	description	handle length
9934900	3/4" drive extendable ratchet	25"-40"



9901205



9901104

Extendable Shaft/Flexible Head Ratchets

These extendable, locking shaft ratchets feature a seventy-two tooth, flexible ratcheting locking head that can angle 180° to tighten or loosen sockets in confined spaces. The extendable locking shafts allow for extra leverage when working with sockets or bolts. Ratchets meets and exceeds ANSI torque requirements. Limited manufacturer LIFETIME WARRANTY on ratchet head assembly.

part no.	description	handle length
9901205	1/2" drive locking flex head, extendable ratchet	13 1/2"-19 1/4"
9901405	1/4" drive locking flex head, extendable ratchet	6 3/4"-8 3/4"
9901104	1/4", 3/8" & 1/2" drive locking flex head, extendable ratchet set	-



Scan for pricing or go to www.delcity.net/catalogpricing



9900920



9900919



9900906



9900900

Razor Scrapers

Perfect for any sticky situation. The scrapers utilize a single edge steel razor blade that can be easily replaced when worn. The 4" compact scraper features a plastic body with slight contour for use in tight spaces. The Monster 6" and 19" scrapers feature a rugged aluminum body and the 19" has a poly foam grip that can store up to 15 blades. If you need a variety of sizes, the Monster kit is the best option as it contains the 4" plastic, 8" and 13" aluminum scrapers, and 100 razor blades in a convenient plastic case.

part no.	description	handle length
9900914	scraper	4" plastic
9900916	monster scraper	6" aluminum
9900919	monster extra long scraper	19" aluminum
9900920	monster scraper kit w/spare blades	4", 8", 13"

Kiwi Pliers 2 Piece Set

The Kiwi pliers are similar to needle nose pliers but feature an angle that provides for better hand alignment. The curved handles provide a more comfortable and powerful hand grip with less effort. The internal spring helps to open the pliers' jaws. Manufactured from heat treated long lasting quality steel.

part no.	description
9907100	6" short nose & 8" long nose

Super Wrist Magnet

A wrist band that has 6 super strong neodymium magnets within it to hold nuts, bolts, tools or other steel hardware. It attaches around your wrist with a Velcro® strap and is rated to hold up to 6 lbs of steel parts.

part no.	description
9900922	super wrist magnet

Telescoping Magnetic Tools

Pick up nuts, bolts, tools and any other hard to reach metal items that are just out of reach. Each features a neodymium rare earth magnet and comfort grip rubber handle. Constructed of aluminum, the telescoping shaft with locking collar conveniently collapses to fit into tool box drawers or storage compartments.

part no.	description	weight capacity	handle length
9900905	monster telescoping magnet	10 lbs	up to 36"
9900907	monster swivel telescoping magnet	10 lbs	up to 38"
9900906	super monster telescoping magnet	20 lbs	up to 38"

Telescoping Hood Props

Provide an economical solution to worn hydraulic hood or lift gate cylinders. Each prop is constructed of tubular aluminum and adjusts like a telescope with an exclusive double locking system. A special guide channel ensures that the lock button will line up every time and the twist collar allows additional strength. The rubber bumpers on each end protect against scraping or chipping of paint and they conveniently collapse to fit into tool box drawers or storage compartments.

part no.	description	handle length
9900901	telescoping hood holder/prop	23"-40"
9900900	monster telescoping hood holder/prop	25"-60"



Scan for pricing or go to www.delcity.net/catalogpricing



990010



990011

Battery Terminal and Post Brush

Removes corrosion from posts and terminals. The top post brush cleans both the battery connection post and terminal. The side post cleaner is designed to clean the battery connection and has a molded housing that can be installed onto a 1/4" ratchet head.

part no.	description
990010	top post battery brush
990011	side terminal cleaner brush

Hybrid Tool Kit



A five piece tool kit designed specifically for hybrid vehicles. The kit includes a 3/8" drive insulated ratchet, 3/8" drive 6" extension, 3/16" slotted insulated screwdriver, two Phillips head screwdrivers and a nylon protective/carry pouch. The tools are rated up to 10,000 volts, CAT III for maximum protection. Includes a manufacturer's limited LIFETIME WARRANTY.

part no.	description
9900924	5 piece hybrid tool kit w/pouch

Sealed Connector Tools

Designed for the positive crimping of sealed connector terminals, these high quality tools are built for long-lasting and dependable service. The removal tools provide for easy removal of terminals. Ratcheting tools assure a perfect crimp every time.



906475

part no.	description
906475	Weather Pack Removal Tool



906485



906495



990174

part no.	description	gauge
906485	Weather Pack self-oriented crimper	20-14
906495	Weather Pack crimper	20-14
990174	Weather Pack and Metri-Pack crimper	22-14



908475

part no.	description
908475	Metri-pack Removal Tool



908485



908495

part no.	description	gauge
908485	Metri-pack crimper	20-14
908495	Packard crimper	12-10

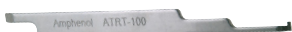

14114100

part no.	description
14114100	AT Series Removal Tool



990170



990172

OEM Type Crimping Tools – Open

Crimps 20–12 gauge OEM type (open barrel) automotive terminals. Five crimping stages. Five dies make rollover crimps on both stranding (electrical crimp) and insulation (strain relief crimp). For crimping terminal numbers: 929895, 929875, 950275, 925725 (see page 89).

part no.	description	crimps gauges
990170	open barrel crimping tool	22–12 ga
990172	heavy-duty crimping pliers	12 ga

hand tools



Scan for pricing or go to www.delcity.net/catalogpricing



Crimping Tool – Non-Insulated/Insulated

An excellent tool for multiple uses. The pliers are a wire cutter, bolt cutter, crimping nest for insulated or non-insulated terminals. Can also strip 22–10 gauge solid or stranded wire. Cuts screw sizes: 4–40, 6–32, 8–32, 18–24, 18–32.

part no.	description	crimps gauges
990198	crimping tool	22–10 ga



Crimping Tool – Non-Insulated/Insulated

Crimps 26–10 gauge insulated and 22–10 gauge non-insulated terminals. Scissor action strips stranded 26–10 AWG and solid 18–8 AWG wire. Two convenient wire cutting stations. Cuts and rethreads 4–40, 6–32, 8–32, 10–24, and 10–32 machine screws. Crimps 7–8mm ignition terminals. Included in kits no. 277 and 809 (see kit section beginning on page 90-98).

part no.	description	crimps gauges
990141	multi-purpose hand crimp tool	22–10 ga, 26–10 ga



Crimping Tool – Non-Insulated/Insulated

For 22–8 gauge non-insulated terminals, 22–14 gauge insulated terminals. Crimps 7mm and 8mm ignition terminals. Strips and cuts wire and also cuts screws. Color-coded crimping nest.

part no.	description	crimps gauges
990145	crimping tool	22–8 ga, 22–14 ga



990163

Ratchet Crimping Tool – Open/Insulated

Tool 990163 crimps both standard and reinforced (double crimp) terminals in 22–10 gauge. Tool 990168 crimps OEM (open barrel) terminals in 22–12 gauge. Both tools will not disengage until uniform crimp is completed or quick release lever is triggered. Dies have printed key for proper crimp nest.

part no.	description	crimps gauges
990163	ratchet crimping tool	22–10 ga
990168	OEM ratchet crimping tool	22–12 ga



990168



990165

Crimping Tools – Insulated

For crimping insulated terminals. Each tool must be fully closed before it will allow itself to open, ensuring a proper crimp.

part no.	description	crimps gauges
990165	ratchet crimping tool	16–8 ga
990160	ratchet crimping tool	22–10 ga



990160

Crimping Tool – Insulated

Crimps 22–10 gauge barrel and insulation terminals and connectors. Also crimps nylon and vinyl-insulated, butted or brazed seam and standard or short barrel terminals. Spring-loaded locator orients, positions and holds terminal and connector. Must be fully closed before tool allows itself to open, to ensure a proper crimp.

part no.	description	crimps gauges
990130	ratchet crimping tool	10–22 ga

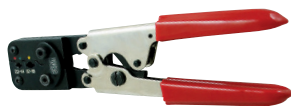

Crimping Tool – Non-Insulated/Insulated

Five-station ratchet tool is a single crimp tool with three stations for insulated 22–10 gauge terminals and two stations for non-insulated 22–10 gauge terminals. The five-station feature allows the tool to serve as a low cost ratchet tool for electrical maintenance and construction.

part no.	description	crimps gauges
990135	ratchet crimping tool	22–10 ga





Scan for pricing or go to www.delcity.net/catalogpricing



Crimping Tool – Shrink Tube

Each cavity is designed to deliver the crimping force that ensures a solid connection without causing damage to heat shrink. Ratcheting mechanism delivers the proper amount of force to each connector. Crimps 24–10 gauge.

part no.	description	crimps gauges
990020	heat shrink, solder sleeve crimping tool	24–10 ga



Crimping Tool – Shrink Tube

This tool not only crimps standard insulated 22–10 gauge terminals, but a breakthrough in design now offers a 4th crimp station for 8 gauge. Each crimp nest is properly coded to gauge size. The long, cushioned handle allows a comfortable, easy and uniform crimp every time. A new mating design ensures that the dies do not slip from side to side. Perfect for all electrical installation jobs.

part no.	description	crimps gauges
990025	ratchet crimping tool	22–8 ga



4 crimp nests



release switch

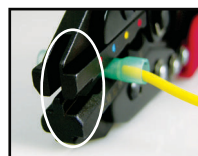

mating mechanism



Crimping Tool

A heavy-duty tool for crimping solderless connectors 8–4/0 gauge (standard copper lug). Can be used with either a hammer or a vice. Spring loaded lever.

part no.	description	crimps gauges
990015	hammer/vice crimper	8-4/0
NEW 990017	impact wrench/ratchet crimper	8-4/0



Junior Crimping Tool

Designed for die cast copper battery terminals and heavy wall copper lugs. Adjustable crimp dies are permanently attached. Features 15" insulated handles.



part no.	description	crimps gauges
990005	junior crimping tool	8–1/0 ga
8000047	replacement kit	–



Heavy Duty Die Cast Terminal Crimping Tool

Designed for all die cast copper battery terminals or lugs. Crimps 6–4/0 gauge. This tool has 26" insulated red handles and a lock button for rotating dies. A chart for selecting the correct die setting is included.



part no.	description	crimps gauges
990000	die cast terminal crimping tool	6–4/0 ga
8000020	replacement die	–



Die Cast Terminal Crimping Tool

Designed exclusively for standard copper lugs. Features 14" handles and is 18" in over-all length. Includes three (3) replaceable crimp dies.



INFORMATION

Die A – 6–4 gauge	Die C – 1–2 gauge
Die B – 1/0–2/0 gauge	w/o die insert– 3/0–4/0 gauge

part no.	description	crimps gauges
990065	die cast terminal crimping tool	4/0–6 ga

hand tools



Scan for pricing or go to www.delcity.net/catalogpricing



Crimping Tool

Can be used to crimp battery terminal sizes 4–4/0 gauge and copper lugs 6–4/0 gauge. The permanently attached crimp head adjusts to the correct size and compresses the lug creating a “V-shaped” crimp. This tool has 20” handles with rubber grips and has an adjustment chart located on the front and back identifying the correct head heights for crimping.

part no.	description	crimps gauges
990001	heavy duty V-style crimping tool	4–4/0 ga, 6–4/0 ga



909555

Professional Grade Ergo Strippers

These wire strippers feature nick-resistant, stainless steel blades & Dual Grip™ ergonomically-shaped handles. The 909550 also crimps #22–#10 gauge insulated terminals. The 909560 features a contoured grip for ease of use. All feature an extended handle to allow for a closer grip to the stripping area.

part no.	description	strip gauges
909550	ergo multi stripper	20–10 ga
909555	ergo multi tool - crimp & strip	22–10 ga
909560	contour ergo multi stripper	20–10 ga



Multi-purpose Wire Stripper

Precision ground cutting edges and a cushion grip with spring return. Looping hole aids in wire pulling and termination. A high precision joint to ensure smooth operation. Anti-glare black oxidation surface treatment for better vision. Three different functions: shears, multi-diameter wire stripper and pliers.

part no.	description	strip gauges
990630	wire stripper	20–10 ga



Multi-purpose Wire Stripper

Precision ground cutting edges and a cushioned grip. Looping hole aides in wire pulling and termination. A high precision joint to ensure smooth operation. Anti-glare black oxidation surface treatment for better vision. Three different functions: shears, wire stripper and pliers.

part no.	description	strip gauges
19015155	multi-purpose wire stripper	20-10 ga
19015156	multi-purpose crimp tool	22-10 ga



Multi-purpose Wire Stripper

Strips copper and aluminum in both solid and stranded wire from 22–10 gauge. Cuts and rethreads bolts 4-40, 5-40, 6-32, 8-32, 10-24 and 10-32. Crimps solderless & ignition terminals. Plier nose for pulling and looping wire.

part no.	description	strip gauges
990143	multi-purpose tool	20–10 ga



Multi-purpose Wire Stripper

Precision ground cutting edge with crimping stations for insulated and non-insulated terminals. Can cut both copper and aluminum wires. The tapered nose allows for cutting in tight locations.

part no.	description
19015157	light-duty crimping pliers



Self-Adjusting Wire Stripper

Self-adjusting wire stripper for 26–10 gauge wire. Crimps insulated, non-insulated and ignition terminals.

part no.	description	strip gauges
990225	self-adjusting wire stripper	26–10 ga



Scan for pricing or go to www.delcity.net/catalogpricing



Spring-Loaded Wire Stripper

Spring-loaded stripper to automatically remove wire insulation without crushing ends. Comfortable no-slip plastic handle to secure a firm grip. Strips 18–10 gauge wire.

part no.	description	strip gauges
990230	spring-loaded wire stripper	18–10 ga



Cable Stripper

This heavy-duty cable stripper removes cable jackets either cutting lengthwise or spiral form.

part no.	description	strip gauges
940405	rotary cable stripper	8 ga–400 MCM



Copper Cable Cutter

Designed to cut copper cable. Made of high quality 1/4" hardened steel. Length: 83/4". Does not cut steel.

part no.	description	cuts gauges
990240	battery cable cutter	8–3/0 ga



Heavy-duty Copper Cable Cutter

Designed to cut copper cable, this cutter has a 22" handle. Does not cut steel.

part no.	description	cuts gauges
990235	heavy-duty copper cable cutter	8–4/0 ga
990236	heavy-duty bench mount cable cutter	8–4/0 ga



Light-duty Flameless Heat Gun

A competitively priced tool that can be held by hand or stand alone. Quickly and efficiently shrinks PVC, polyolefin, dual wall, crimpable shrink tubing and no-crimp solder terminals. Solid state construction: powerful dual set, 600°F/1000°F 1200W and 10 amps self-standing. Perfect for shrink tubing. Includes shrink tube reflector. For light-duty use only.

part no.	description
990110	flameless heat gun



Mini-Torch

Economical, self-igniting mini-torch. Temperature range up to 1300°C (2500°F). Includes a refillable fuel cell. Meets Consumer Products Safety Commission (CPSC) Child Safety Requirements. Does not include butane.

part no.	description
945000	economical butane mini torch



Butane Power Torch

This versatile heat tool is fast and lightweight. Perfect for heat shrinkable connectors and tubing, soldering and a variety of other applications. The tank capacity will provide approximately 70 minutes of continuous usage. Does not include butane.

part no.	description
946005	butane power torch



Portable Heat Tool

Convenient butane powered flameless heat tool and soldering iron kit that is self-igniting and cordless. Kit comes complete with heat shrink attachment, soldering and heat tips, protective cap, spanner and open wrenches, as well as installation and application instructions. Tank holds 1oz 28ml (15.8gm) of butane and can operate up to 2 hours on #3 setting. Temperature ranges vary from 482°F up to 1202°F, depending on application tip usage. Part number 990100 holds 20ml of butane with a heat rating up to 950°F.

part no.	description
990105	portable heat tool



Scan for pricing or go to www.delcity.net/catalogpricing



Circuit Alert™ Voltage Sensor

A tri-directional voltage sensor with a momentary On/Off switch. Includes a snap-on pocket clip. A red light and rhythmic sound activate if a voltage greater than 50V AC is present. Fits all Circuit Alert™ tools.

part no.	description
989300	Circuit Alert™ volt sensing module



Circuit Alert™ Wire Stripper

Strips #10–18 gauge solid or stranded wire. Bolt cutting station cuts bolts & reforms threads. Stainless steel material provides maximum corrosion resistance. Knurled pliers nose and looping stations. Dual grip positions. A red light and rhythmic sound is activated if a voltage greater than 50V AC is present. Detachable circuit tester.

part no.	description	strip gauges
989400	Circuit Alert™ wire stripper	10–18 ga



Circuit Alert™ Voltage Stripper & Crimper

Strips #8–20 AWG solid or stranded wire. Bolt cutting station cuts bolts & reforms threads. Stainless steel material provides maximum corrosion resistance. Knurled pliers nose and looping stations. Dual grip positions. A red light and rhythmic sound is activated if a voltage greater than 50V AC is present. Detachable circuit tester.

part no.	description	crimp & strip gauges
989405	Circuit Alert™ wire stripper	8–20 ga



Circuit Alert™ Wire Stripper, NM Romex™

Strips 14–2 & 12–2 NM cable. Bolt cutting station cuts bolts & reforms threads. Stainless steel material provides maximum corrosion resistance. Knurled pliers nose and looping stations. Dual grip positions. A red light and rhythmic sound is activated if a voltage greater than 50V AC is present. Detachable circuit tester.

part no.	description	strip gauges
989410	Circuit Alert™ wire stripper, NM romex	14–2 ga, 12–2 ga



Circuit Alert™ Voltage Sensing Long Nose Pliers

All in one tool! Allows you to cut wire and cable, crimps terminals, twists connectors, strips wire and tests for voltage. Built-in wire stripper is designed for #18 stranded wire. Knurled plier jaws and precision cutting blades. Forged steel construction for long life. Diagonal cutting head. A red light and rhythmic sound is activated if a voltage greater than 50V AC is present. Detachable circuit tester.

part no.	description
989205	Circuit Alert™ long nose pliers, 8"



Circuit Alert™ Voltage Sensing Linesmens Pliers

All in one tool! Allows you to cut wire and cable, crimp terminals, hammer staples and test for voltage. Cross knurled jaws and precision hardened cutting blades. Forged steel construction for long life. Diagonal cutting head. A red light and rhythmic sound is activated if a voltage greater than 50V AC is present. Detachable circuit tester.

part no.	description
989210	Circuit Alert™ linesmens pliers, 9"



Circuit Alert™ Voltage Sensing Screwdrivers

Drives both screws and wire connectors. Non-magnetic bit lock system. Bits can be stored in the insulated shaft and handle. A red light and rhythmic sound is activated if a voltage greater than 50V AC is present. Detachable circuit tester. Includes #2 phillips and 1/4" flathead bits.

part no.	description
989500	Circuit Alert™ 3-in-1 screwdriver



Scan for pricing or go to www.delcity.net/catalogpricing



Circuit Alert™ Voltage Sensing Screwdrivers

Drives both screws and wire connectors. Non-magnetic bit lock system. Bits can be stored in the insulated shaft and handle. A red light and rhythmic sound is activated if a voltage greater than 50V AC is present. Detachable circuit tester. Includes #1 & #2 phillips, 3/16" & 1/4" slotted, R1 & R2, #10 & #15 torx and 1/4" hex bits.

part no.	description
989510	Circuit Alert™ 10-in-1 screwdriver



Circuit Alert™ Voltage Sensing Electrician's Knife

Change the blade quickly with the push of a button. Heavy-duty blade with metal blade support. Strips wires up to 12 gauge. Includes NM cable ripper for #12/2 and #14/2 cable. Convenient blade storage compartment. A red light and rhythmic sound is activated if a voltage greater than 50V AC is present. Detachable circuit tester.

part no.	description
989100	Circuit Alert™ utility knife, with wire stripper

LED Pocket Light Stick



A rugged, pocket sized light that features six super bright LEDs. Three AAA batteries provide up to 11 hours runtime and 36 Lumens to illuminate hard to reach, tight areas. This light provides both a floodlight effect and directional illumination pattern. Added features include a molded plastic clip to stay in your pocket, and a water resistant housing.

part no.	description
75606	pocket LED light stick, 6 diode

LED UV Pocket Light Stick



A rugged, pocket sized light that features six super bright UV LED's. Three AAA batteries provide up to 11 hours runtime. Housing is a bright safety color and is water resistant.

part no.	description
75608	UV LED light stick, 6 diodes



75630

LED Rechargeable Work Light

Features a new wide angle LED technology with 30 super brilliant 100,000 hour floodlight style LEDs, which provides a light output of 140 lumens. Housed within its rugged ABS industrial grade housing and grip with lens guard, is a NiMh battery pack that can run up to 10 hours per charge (1,000 charge cycles). Added features include a LED low battery indicator, super strong polycarbonate high strength swivel hook and 120 volt "smart" charger.

part no.	description
75630	LED rechargeable work light, 10 hour 30 diode

LED 2-in-1 Rechargeable Worklight / Flashlight



This 2-in-1 tool can be used as a flashlight or freestanding worklight with its handy magnetic base. The flashlight illuminates 6 bright LEDs with a touch of the button. Simply extend the handle of the flashlight and a 30 LED worklight automatically provides illumination perfect for use under-the-hood automotive repair, on benchtops, or in any other work area.

part no.	description
75661	LED 2-in-1 rechargeable worklight & flashlight

Cordless Work Light 



This cordless, rechargeable work light allows for "take-n-go" freedom with the convenience of charging while working or in the car. The work light illuminates up to 4 hours on 1 charge. Includes 13 watt halogen bulb, 120V AC plug and car charger.

part no.	description
75664	rechargeable cordless work light

hand tools



Scan for pricing or go to www.delcity.net/catalogpricing



Trouble Lights

All models meet OSHA specifications. 13A, 125V, 1625W. On-off switch and side outlet. Metal hood. Maximum 75 watt bulb. U-Ground NEMA 5-15.

part no.	description	gauge/conductor
75544	25' cord/SJT	16/3
75546	50' cord/SJT	16/3



Portable Fluorescent Work Lights

Shatter-resistant housing and non-glare reflector. Hanging hook swivels 360°. A starter switch is built into the handle. Cord is 18/2 SJT with a plug-in ballast. Energy saving fluorescent bulb included.

part no.	description
75562	25' fluorescent work light
75566	25' fluorescent work light

Indoor/Outdoor Extension Cords

Single outlet extension cords. Type SJTW-A extra flexible cords. All-weather with oil restraint -40°C (-40°F), 300V rating: 15A, 125V, 1875W.



part no.	description	gauge/conductor
75518	25' cord	14/3
75520	50' cord	14/3
75524	25' cord	12/3
75526	50' cord	12/3

Expandable Tubing Hot Knife

Expandable sleeving should be cut with a hot knife cutting tool or similar heated blade to keep the material fibers together. This bench mount 110 volt AC tool enables the operator to draw flexible sleeving down across the knife blade under tension. Both hands are then free to seal and flare ends. Must be used in a well ventilated area. Instructions printed on the tool.



Use With
expandable
sleeving
PAGE 36-37



part no.	description
990070	expandable tubing hot knife

Fish Tape

Ideal for short fishing runs in existing structures. Special steel wire does not curl up when extended allowing the tape to be easily fed over suspended ceilings, down walls and under carpeting. Ergonomic handle is positioned to function as a pulling grip and a convenient reel handle to allow quick retrieval of tape. Aerodynamic tip reduces friction, requiring less force and decreasing hang-ups.



part no.	description
990360	Cable Snake™ fish tape, 25'

Fish Tapes

Tape is wound directly into housing; no need to snap retaining tapes. Exclusive hand trigger assembly helps wind tape tightly as it automatically wipes off excess lubricant. Form fitting finger grips around reel fit the hand comfortably. Shatter-proof reel stands up to on-the-job abuse. Four viewing ports on reel tell at a glance how much tape remains. Easy disassembly for fast replacement of tape. Includes fish tape ball that glides through tricky bends without sticking or snagging. 250 lb. pulling strength.



part no.	description	size	reel diameter
990365	fish tape, 50'	1/8" x .060	8 7/16"
990385	fish tape, 100'	1/8" x .060	12"
990395	fish tape, 240'	1/8" x .060	12"



Rack for Metal Boxes

Heavy-duty steel racks holds up to four (4) metal scoop boxes. Baked gray hammerstone finish. Order boxes separately.

part no.	descriptions	fits box no.	fits kit no.	weight (lbs)
990275	4 drawer rack for 135/8" x 9 1/4" x 2" boxes h: 11 1/4", w: 15 1/4", d: 11 3/4"	990250	650	22
		990265		
990280	4 drawer rack for 18" x 12" x 3" boxes h: 15", w: 20", d: 15 3/4"	990255	275, 276, 277 75045, 75043	37
		990270		



Scan for pricing or go to www.delcity.net/catalogpricing



Scoop Boxes

Ideal for organizing and storing small parts. Rounded bottoms to make scooping out parts quick and easy. Model 990260, 990261 and 80660 are high strength clear polyethylene plastic; all other models are constructed of steel. Models 990250 and 990255 have one larger compartment for hand tool storage.



part no.	descriptions	number of compartments	weight (lbs)
80660	6 7/8" x 3 9/16" x 1 7/16"	12	1
990250	13 5/16" x 9 1/4" x 2"	21	4
990255	18" x 12" x 3"	21	4
990260	11" x 6 1/2" x 1 1/4"	13	1
990261	11" x 6 1/2" x 1 1/4"	18	1
990265	13 5/16" x 9 1/4" x 2"	24	4
990270	18" x 12" x 3"	24	4

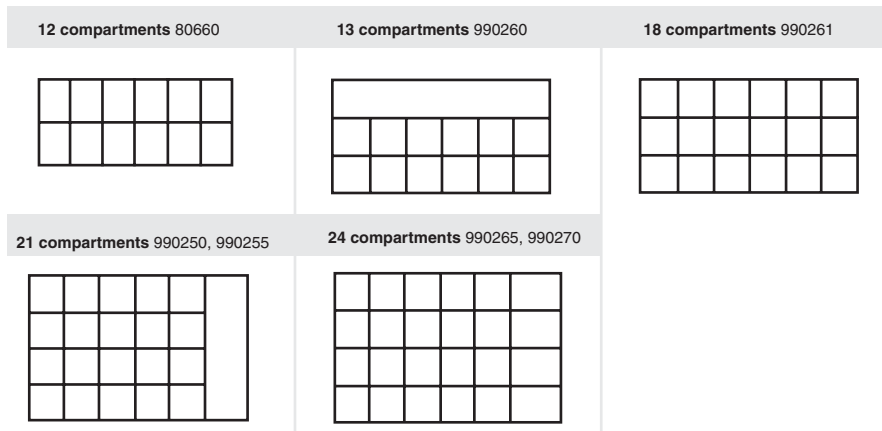

NEW

Mobile Wire Cart

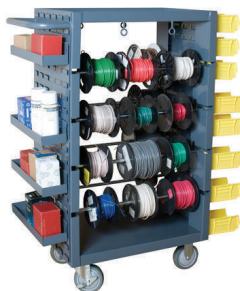

Perfect for maintenance facilities, garages and construction sites, the mobile wire spool and product rack provides efficiency and space to your work environment. The mobile cart allows for multiple types of wire or other spooled items such as loom to be organized and readily available. It features four 5" x 1-1/4" polyurethane casters (2 fixed, 2 free), two louvered side panels for 4" x 5" plastic (part number 9900811) and 4" x 8" metal bins (part number 9900813). It is manufactured from heavy-duty, all welded 14 gauge steel and has a 1,200 lb capacity. 26" W x 18" D x 46" H.

part no.	description
9900810	mobile wire cart (bins not included)
9900811	yellow plastic bins, 4" X 5"
9900812	yellow plastic bins, 4" X 8"
9900813	adjustable metal shelf, 4" X 18"
9900814	mobile wire cart w/bins



Scan for pricing or go to www.delcity.net/catalogpricing

NEW

Automotive Electrician's Tote



This kit contains a large assortment of the most commonly used products when working on a installation job. The bottom drawer is compartmentalized to keep small items easy to find and organized. Kit includes terminals, cable ties, shrink tube, wire, tools and tape.

For a complete listing of kit contents, see page 328.

part no.	description	pieces
9900800	automotive electricians kit	618

NEW

Table Top Wire Rack & Terminal Kit



This versatile wire rack comes with a sliding top drawer that houses 18" x 12" x 2" size scoop box that comes with an assortment of terminals. Rack can hold a wide combination of 100' to 500' spools of assorted wires. It is manufactured from heavy-duty powder coated steel for durability. Available with and without terminals.

part no.	description
9900815	table top wire rack & terminal kit
9900816	table top wire rack only

LED Pocket Light Stick



A rugged, pocket sized light that features six super bright LEDs. Three AAA batteries provide up to 11 hours runtime and 36 Lumens to illuminate hard to reach, tight areas. This light provides both a floodlight effect and directional illumination pattern. Added features include a molded plastic clip to stay in your pocket, and a water resistant housing.

part no.	description
75606	pocket LED light stick, 6 diode

LED 2-in-1 Rechargeable Worklight / Flashlight



This 2-in-1 tool can be used as a flashlight or freestanding worklight with its handy magnetic base. The flashlight illuminates 6 bright LEDs with a touch of the button. Simply extend the handle of the flashlight and a 30 LED worklight automatically provides illumination perfect for use under-the-hood automotive repair, on benchtops, or in any other work area.

part no.	description
75661	LED 2-in-1 rechargeable worklight & flashlight



Hand Caddy

Convenient hand carrying or dispensing of small quantities of reeled wire. Rugged construction from 5/8" .083 steel tubing; epoxy coated to reduce chipping and peeling. Holds up to 8 reels, each 7" diameter by 5" wide; or 4 reels, each 7" diameter by 6" to 10" wide.

part no.	description	dimensions
75567	hand caddy	22½"(L) x 13½"(W) x 9½"(H)



Scan for pricing or go to www.delcity.net/catalogpricing



Spool Caddy Cart

Transport and dispense reels of building wire, coaxial and multi-conductor cables. Hand caddy model 75567 is included. The caddy is easily attached to and detached from cart for maximum capacity and flexibility. Constructed of 5/8" .083 steel tubing; holds up to 300 lbs. Semi-pneumatic steel wheels are much more durable than plastic wheels. Special patented channel allows up to two caddies to attach to cart.

part no.	description	dimensions
75570	spool caddy cart	22½"(L) x 16"(W) x 43"(H)



Wire Spool Rack

For convenient storing and dispensing of wire. Heavy-duty steel with gray finish. Keyhole slots for wall mounting. Four plated steel tubes to hold heavy spools as large as 10" in diameter. Recommended for : 33/4", 61/2", and 81/2" spools.

part no.	description	dimensions
990285	heavy-duty wire rack	26"(L) x 5¾"(W) x 36½"(H)



Knockout Set

Four-point design allows slugs to drop out of the die automatically without splitting. Perfect for chassis builders, metal fabrication and other OEM/MRO applications. Durable punches make holes in up to 12 gauge stainless steel and 10 gauge mild steel.

part no.	description	pipe sizes	hole size O.D.
992100	knockout set	½", ¾", 1", 1¼"	7/8", 1⅜", 1⅞", 1⅞"



Ratchet Wrench Knockout Set

Four-point design allows slugs to drop out of the die automatically without splitting. Perfect for chassis builders, metal fabrication and other OEM/MRO applications. Durable punches make holes in up to 12 gauge stainless steel and 10 gauge mild steel. Includes a handy ratchet mechanism for application ease. The complete set punches holes from 1/2" to 2".

part no.	description	pipe sizes	hole size O.D.
992102	knockout set	½" – 2"	7/8" – 2⅜"

specialty testers



Scan for pricing or go to www.delcity.net/catalogpricing



Battery & Alternator Voltage Analyzer

Excellent for checking automotive, marine and industrial 12 volt equipment. Strong steel tip effortlessly pierces wire insulation for testing. Easily finds broken wires in circuit as bulb will stop glowing at dead point.

part no.	description
990200	battery & alternator voltage analyzer



Tru-Spark™ Ignition Firing Indicator

Quickly and accurately tests DIS and other ignition systems for the presence of secondary voltage. Tests without piercing or removing spark plug wires. Sensitivity adjustment dial. High visibility 360° indicator. High impact ABS housing. Designed to meet the needs of the professional service technician.

part no.	description
991200	Tru-Spark™ ignition firing indicator



12V DC Automotive Tester

Quickly indicates alternator output and status of battery charge. LED lights show normal, low or flat level of battery charge. Durable case with magnetic strip on back adheres to any steel surface for safe operation.

part no.	description
991085	12V DC automotive tester



Hydrometers

Provide an easy visual inspection that identifies if the acids or solutions are in their proper state. The windshield washer hydrometer tests methanol and the antifreeze hydrometer tests ethylene glycol on a temperature scale from -51°C to 0°C (-60°F to 32°F), suggesting that the solutions are properly mixed to prevent freezing. The battery hydrometer tests battery acid and suggests a low, fair, or good rating in the range of 1.100–1.100sg. Hydrometers are made of plastic with rubber squeeze bulb that can extract up to 4 oz.

part no.	description
9900932	antifreeze hydrometer, ethylene glycol tester
9900435	battery hydrometer, acid tester



Refractometer

Provide the most accurate way of testing the concentration of acid and ethylene glycol or propylene glycol levels in antifreeze. Each refractometer comes complete with screwdriver, eyedropper, and padded case. The refractometer has an adjustable lens focus as well as a calibration adjustment screw and it reads in both Fahrenheit and Centigrade.

part no.	description
9900930	handheld refractometer, glycol tester



Trailer Connector Tester

LED trailer connector tester confirms and analyzes tail light, turn signal and ground connections from your vehicle.

part no.	description
73095	4-way trailer connector tester
73097	7-way flat trailer connector tester



Scan for pricing or go to www.delcity.net/catalogpricing



9900501



9900502

Battery Load Tester

Can be used with conventional and maintenance-free lead acid batteries. Both test 6 and 12 volt batteries and provide analog test readings. The 9900501 features copper plated clamps, tests completely in 10 seconds and has operating instructions displayed on back of tester. The 9900502 features a pistol grip, insulated heavy-duty copper clamps and performs state of charge, battery load, starter and charging system diagnostic tests.

part no.	description
9900501	analog battery load tester
9900502	pistol grip load tester, 125A



9900601

Automotive Memory Savers

A device for saving all drivability codes and memory settings in a vehicle that needs to have its battery disconnected. It's a self sealed contained unit requiring no additional source of power and includes a 12V 5 amp/hour sealed lead acid battery, as well as, LED that indicates connection to battery circuit. The unit is protected by a 4A circuit breaker and connects to a vehicle with a direct wired OBD2 connector. The OBD2 connector and 12 volt plug end is connected by a coiled cord that stretches up to eight feet. It's designed to be used with an alternate power source, such as a battery booster pack.

part no.	description
9900601	automotive memory saver battery unit



Analog Earth Resistance Tester



Verify the effectiveness of any ground type with this rugged test instrument. The low 2mA current prevents the tripping of Earth leakage breakers while under test. Earth resistance value reads directly from scale plate. The Earth Resistance Tester is self powered, no hand crank needed. It is very compact, lightweight and portable for on-the-go testing. Identify battery capacity with the quick battery check. Meets IP54 standards. Operates from (6) AA batteries.

part no.	specifications	range
19103287	OHM	0-12, 120, 1200Ω
	AC voltage	0-30V
	mid-scale	5Ω/x1, 50Ω/x10, 500Ω/x100
	accuracy	+3% FS
	battery check	yes
	test button lock	yes



Digital Insulation Tester



Verify the integrity of wire insulation and connectivity of wire runs with this compact test unit. The auto null function to subtract the test lead resistance. Use the test button release to automatically discharge any charge stored within the circuit under test. It also features an audible live circuit warning beeper. Manufactured to meet dust and drip proof IP54 standards. Tester also features test button lock and auto discharge. Operates from (8) AA batteries.

part no.	specifications	range
19103218	MegΩ/DC test voltage	0-20M, 200M, 2000M, 250V 0-20M, 200M, 2000M, 500V 0-20M, 200M, 2000M, 1000V
	continuity	0-20, 200, 2000Ω
	accuracy	± 1.5% rdg ±5dgt @ 20MΩ ± 1.5% rdg ±5dgt @ 200MΩ ± 1.0% rdg ±3dgt @ 2000MΩ
	continuity accuracy	± 1.5% rdg ±5dgt (20Ω) ± 1.5% rdg ±3dgt (200/2000Ω)
	live circuit warning	buzzer

specialty testers

Analog Insulation Tester



Test the continuity and wire insulation of long wire runs. The enhanced multi-colored scales are designed for easy reading. Earth resistance is read directly from scale plate and is self-powered. It is a compact and portable unit that features a live circuit neon indicator plus audible warning signal, quick battery check and front panel zero ohm adjustment. Meets IP54 standards. Operates from (6) AA batteries.

part no.	specifications	range
19103232	DC test voltage	250V, 500V, 1000V
	OHM	0-3/500Ω
	AC voltage	0-600V
	mid-scale	1MΩ/250V; 2MΩ/500V; 4MΩ/100V
	accuracy	±5%rdg; ±1.5% of scale length
	live circuit warning	lamp & buzzer
	test button lock	yes
	zero OHM adjust	yes
	battery check	yes
	auto discharge	yes



Test Box

Provide diagnostics for RV step service. Tester isolates step function from RV power and wiring, allowing you to pin-point the problem, then replace the parts needed.

part no.	description
909518000	KWIK TEST control unit test box



Temp Check™ Pocket Infrared Thermometer

This digital thermometer features a 6:1 distance to spot ratio and has a laser sight to pin-point accurate results. Toggle between Fahrenheit and Celsius with the ability to hold both minimum and maximum readings in max mode. Conserve battery life with auto power off.

part no.	specifications	range
19065233	temperature range	(-31 to 689°F) -35 to 365°C
	emissivity	fixed
	laser sighting	yes
	lock mode	yes
	low battery indicator	yes
	auto off	yes



Digital Thermometer

Safely and accurately measure surface temperatures of non-reflective materials. Lightweight and easy to use with a backlit display. Spot ratio 8:1. Temperature range: -35°C to 365°C (-31°F to 689°F).

part no.	description
992205	infrared digital thermometer



Scan for pricing or go to www.delcity.net/catalogpricing

Phase Sequence and Open Phase Indicator



Verify proper wiring and connection in 3-phase motor applications. Alligator clips feature color-coded insulation for added protection, a visual rotation indication and LED indication of phase wiring. The housing is manufactured from shock resistant plastic, is compact and lightweight for easy handling. Withstands 5500V AC for 1 minute.

part no.	specifications	range
19107018	AC voltage	110–600V
	push switch button	yes
	road operating range	yes
	visual indication	yes
	color coded clips	yes



Scan for pricing or go to www.delcity.net/catalogpricing



5-in-1 Multi Scanner



Simplify the installation of electrical boxes, switches and outlets with this stud and AC voltage finder. Choose from 3 modes: stud, metal or AC voltage scan. The metal scan can detect metal pipes or objects to a maximum depth of 2.5" through .5" thick drywall and wood studs, up to .75" depth. It also can detect AC voltage (50–600V AC) to a maximum depth of 3.5" through .5" thick drywall. A built-in metal tip allows for marking when stud, metal object or AC voltage is found. An added feature integrates a 3-wire circuit analyzer with GFCI test functionality. Rubber over-mold provides a comfort grip when in use. Audible and visual indication. Operates from one 9-volt battery.

part no.	specifications	range
19064816	operational voltage	120V AC
	non-contact AC voltage	50–600V
	frequency	60Hz
	circuit analyzer	yes
	GFCI	yes
	metal detection	yes
	metal studs	yes



Circuit Breaker Finder



Quickly locate AC circuit breakers or fuses to ensure a safe working condition. Power interruption is not needed and is safe for use near sensitive electronic equipment. Audible sound and visual LED indicators are used for the alert. Includes both transmitter and receiver. Receiver operates from one 9 volt battery.

part no.	specifications	range
19064830	operational voltage	120V
	frequency	60Hz
	plug-in transmitter	yes
	insulated leads	yes
	socket adapter	yes



Heavy-duty Voltage Tester



This Heavy-duty Voltage Tester tests voltages ranging from 120–600V AC/DC and has a solenoid vibration and polarity indication built in. This tester features heavy-duty 36" Sta-Flex cold weather leads, integral probe storage that allows snap-in leads to be spaced in the proper placement to fit into a standard outlet for easy, single hand testing, wire lead strain reliefs, and a special over-molded grip.

part no.	specifications	range
19000611	AC voltage	120–600V
	DC voltage	120–600V
	frequency	50–60Hz
	polarity	yes
	vibration	yes
	continuity	–
CAT rating	III 600V	

specialty testers



Scan for pricing or go to www.delcity.net/catalogpricing



Volt Doctor™ Voltage-Continuity Tester



This voltage and continuity tester is designed for the most demanding applications. It can test voltages from 120–600V AC/DC. It incorporates voltage indication through both solenoid and bright visual indicators. There is audible and visual indicators when used to test continuity. It also features heavy-duty 36" Sta-Flex cold weather leads, integral probe storage that allows snap-in leads to be spaced in the proper placement to fit into a standard outlet for easy, single hand testing, wire lead strain reliefs, and a special over-molded grip. Continuity function operates from (2) LR44 button cell batteries.

part no.	specifications	range
19064762	AC voltage	120–600V
	DC voltage	120–600V
	frequency	50–60Hz
	polarity	yes
	vibration	yes
	continuity	yes
	CAT rating	III 600V



Volt Check™ Voltage-Continuity Tester



Volt Check™ is a multi-function tool that tests voltage and continuity, senses AC voltages in the range from 24–600V AC and DC voltages from 6–220V DC. It has a non-contact sensor that senses 50–1000V AC only. Smart Meter Technology automatically adjusts the tester to voltage, continuity, or range and also allows you to test for AC current with a non-contact Circuit Alert™ tester that is built into the tip of the tester. Other features include, 36" yellow and black Sta-Flex cold weather leads, built in probe storage, convenient magnetic back that attaches to any metal surface. Operates on (3) AAA batteries.

part no.	specifications	range
19061000	contact AC voltage	24–600V
	non-contact AC voltage	50–600V
	DC voltage	6–220V
	frequency	50–60Hz
	polarity	yes
	continuity	yes
	audible	yes
CAT rating	III 1000V, IV 600V	

specialty testers

Heavy-Duty, Voltage-Continuity Tester



Heavy-duty voltage and continuity tester designed for any number of job site applications. Test voltage from 80–480V AC/DC (4-range indication). This versatile tester performs dual function voltage and continuity. The Sta-Flex, 36" cold weather snap-in leads are spaced to fit the standard outlets for "hands free" operation. An over-mold of the heavy-duty construction allows for durability and comfortable use. Four Hi-Vis indicators allow for accurate outputs. Features an integrated probe storage. Operates from (2) LR44 batteries.

part no.	specifications	range
19064748	AC voltage	80–480V
	DC voltage	80–480V
	frequency	60Hz
	polarity	yes
	continuity	yes
	CAT rating	III 600V



Scan for pricing or go to www.delcity.net/catalogpricing

Circuit-Alert™ Non-contact Voltage Tester



Tests from 50–600V AC. Visual (flashing) and audible (beeping) indicators signal presence of voltage. Built-in "safe-test" feature assures batteries are operating properly. Compact design; batteries included.

part no.	description
990995	Circuit Alert™ non-contact voltage tester

Non-Contact Volt Sensor™



Verify the presence of AC voltage prior to working on any application. This Non-Contact Voltage Detector senses voltage from 50–1000V AC, and features an audible and 360° visual indication. Other features include operating on a single AAA battery (included), a patented battery test feature and convenient pocket clip that attaches to any tool belt.

part no.	specifications	range
19006504	AC voltage	50–1000V
	frequency	50–60Hz
	adjustable	–
	CAT rating	III 1000V, IV 600V

Adjustable Non-Contact Volt Sensor™



The adjustable Volt Sensor allows for sensitivity adjustments in multiple-wire applications when precision and safety are crucial. The voltage sensitivity can be adjusted from 12–1000V AC. When voltage is found, there is an audible beep and 360° visual indicator illuminated. Operates from a single AAA battery.

part no.	specifications	range
19064793	AC voltage	12–1000V
	frequency	50–60Hz
	adjustable	yes
	CAT rating	III 1000V, IV 600V

GFCI Receptacle Tester & Circuit Analyzer



Tests ground fault breakers by overloading circuit and tripping GFCI. Tests for seven conditions: ground fault interruption, open ground, open neutral, open hot, hot/ground reverse, hot/neutral reverse and correct wiring. The succession of yellow and red lights provide indication of circuit status or specifies which wire is defective. Tester trips GFCI between 6–9mA.

HOW IT WORKS

Simply plug tester into any circuit protected by ground fault receptacle (110–125 volts AC) and press black button to overload circuit.

part no.	description
990980	GFCI receptacle tester & circuit analyzer



Scan for pricing or go to www.delcity.net/catalogpricing



Stop Shock™ GFCI Circuit-Ground Analyzer



Advanced circuitry detects hazardous ground conditions not identified by standard outlet testers. Tests standard 3-wire and GFCI protected 120V outlets. The neon lamps indicate 7 common wiring conditions with a legend printed on the bottom of the tester. GFCI function tests GFCI and standard outlets wired in series with GFCI outlets (e.g. multiple outlets in kitchen or bath). The comfort, over-mold grip and compact, ergonomic design allow for easy insertion and removal.

part no.	specifications	range
19064687	operational voltage	120V AC
	frequency	60Hz



GFCI Outlet Tester



Tests standard 3-wire and GFCI protected 120V outlets. The neon lamps indicate 7 common wiring conditions with a legend printed on the bottom of the tester. GFCI function tests GFCI and standard outlets wired in series with GFCI outlets (e.g. multiple outlets in kitchen or bath). The comfort, over-mold grip and compact, ergonomic design allow for easy insertion and removal from outlets. Ideal when multiple tests are needed.

part no.	specifications	range
19006302	operational voltage	120V AC
	frequency	60Hz



Range Voltage Tester



Tests for voltage from 80–480V AC/DC. This testers patented, snap-in leads are spaced proportionately to fit directly into a standard outlet while they rest in its integral probe storage. This design allows for single hand testing.

part no.	specifications	range
19006204	AC voltage	80–480V
	DC voltage	80–480V
	frequency	60Hz
	pocket clip	yes
	CAT rating	II 600V



Single Range Voltage Tester



Tests for voltage from 80–250V AC/DC. This tester's patented, snap-in leads are spaced proportionately to fit directly into a standard outlet while they rest in its integral probe storage. This design allows for single hand testing.

part no.	specifications	range
19064717	AC voltage	80–250V
	DC voltage	80–250V
	frequency	60Hz
	pocket clip	yes
	CAT rating	II 300V



Screwdriver-Voltage-Continuity Tester



The three function voltage & continuity tester with screwdriver tip tests voltages from 12–250V AC/DC, as well as, for continuity. This tester features a compact design, 360° visual indication, a screwdriver tip that works with many common screw sizes. Operates with (2) LR44 button cell batteries.

part no.	specifications	range
19006401	AC voltage	12–250V
	DC voltage	12–250V
	continuity	yes



Heavy-Duty Continuity Tester



Test for breaks in non-energized wires or cords. The heavy-duty tip easily pierces most coverings and features a 36" flexible lead with insulated alligator clip. A bright 360° indicator provides visual confirmation. Operates from (2) AAA batteries.



Scan for pricing or go to www.delcity.net/catalogpricing

part no.	specifications	range
19064878	pocket clip	yes
	visual indication	yes



Circuit Breaker Finder

Identifies individual branch circuits at the panel box without interrupting power. Easy to use transmitter has an operating range of 80-140V AC max to ground. Audible and visual transmitter and indicators. Operating temperature: 0°C to 50°C (32°F to 122°F).

part no.	description
19104444	circuit breaker finder

specialty testers



Scan for pricing or go to www.delcity.net/catalogpricing



4 Function Digital Multimeter



The manual range digital multimeter is a compact multimeter designed to exceed the expectations of professional electricians. It is capable of testing for AC & DC volts, resistance and battery test. The ergonomic design features a rubber grip and is benchmark proven for durability against impact, heat, vibration and crush. Operates from one 9 volt battery.

part no.	specifications	range	accuracy
19006200	DC voltage	200mV, 20, 200, 600	200mV & 600V (1.2%+2dgt) 20V 200V (1.0%+2dgt)
	AC voltage	200/500	2.5%+5dgt
	resistance	200, 2K, 20K, 200K, 2M	200Ω (1.5%+2dgt) 2K 20K 200K 2M (1.2%+2dgt)
	battery testing	(1.5V) 2000mV/(9V) 20V	1.0%+2
	CAT rating	III 600V	-



7 Function Digital Multimeter



This multimeter automatically determines the resolution based on the application. Digital screen provides clear and easy viewing. It tests AC & DC voltage, resistance, battery testing, temperature diode testing and continuity. The compact, lightweight design features an impact resistant housing with rubber overmold. Operates from (2) AAA batteries.

part no.	specifications	range	accuracy
19065264	DC voltage	200mV, 2V, 20V, 200V, 600V	200mV & 600V (1.0%+5dgt) 2V 20V 200V (0.5%+5dgt)
	AC voltage	200mV, 2V, 20V, 200V, 500V	500V (1.5%+5dgt) 2V 30V 200V (0.8%+5dgt)
	resistance	200, 2K, 200K, 2M, 20M	200Ω 20M (1.5%+2dgt) 2K 20K 200K 2M (1.0%+2dgt)
	battery testing	1.5V (2V)	-
	temperature	-40°F to 752°F	8%+5dgt
	diode test	yes	-
	continuity	yes	-
	CAT rating	III 600V	-



8 Function Digital Multimeter



Test up to 8 different functions and view results in the industry leading LCD display size. The data hold feature captures reading on the display and the test lead input icons ensure correct lead placement. Test AC & DC volts, AC & DC draw, resistance, battery & diode testing and continuity. Housing features a protective rubber boot over the rugged housing. Operates from one 9 volt battery.

part no.	specifications	range	accuracy
19065271	DC voltage	200mV, 2V, 20V, 200V, 1000V	200mV 2V 20V 200V (0.5%+2dgt) 1000V (0.8%+3dgt)
	AC voltage	2V, 20V, 200V, 750V	2V 20V 200V (0.8%+ 5dgt) 750V (1.0%+5dgt)
	DC amps	200uA, 2mA, 20mA, 200mA, 10A	200μA 2000μA 20mA 200mA (0.8%+2dgt) 10A (1.2%+5dgt)
	AC amps	200uA, 2mA, 20mA, 200mA, 10A	200μA 2000μA 20mA 200mA (1.0%+5dgt) 10A (1.2%+5dgt)
	resistance	200, 2K, 20K, 200K, 2M, 20M	200 2K 20K 200K 2M (0.8%+3dgt) 20M (1.2%+5dgt)
	battery testing	(1.5V) 2000mV/(9V) 20V	-
	diode test	yes	-
	continuity	yes	-
	CAT rating	III 600V, II 1000V	-



9 Function Digital Multimeter

This 9 function multimeter features one of the largest displays available in the industry. It has functions capable of testing for AC & DC volts, AC current, DC current, resistance, diode testing, continuity (audibly), capacitance, frequency and many other features. Additionally, this multimeter is ergonomically styled with rubber gripping areas and is benchmark proven for durability against impact, heat, vibration and crush.



Scan for pricing or go to www.delcity.net/catalogpricing

part no.	specifications	range	accuracy
19006450	DC voltage	400mV, 4V, 40V, 400V, 1000V	400mV (0.8%+3dgt) 4V 40V 400V (0.8%+1dgt) 1000V (1.0%+3dgt)
	AC voltage	4V, 40V, 400V, 750V	4V 40V 400V (1.0%+ 5dgt) 750V (1.2%+5dgt)
	DC amps	400µA, 4000µA, 40mA, 400mA, 4A, 10A	400µA 4000µA (1.0%+2dgt) 40mA 400mA (1.2%+3dgt) 4A 10A (1.5%+5dgt)
	AC amps	400µA, 4000µA, 40mA, 400mA, 4A, 10A	400µA 4000µA (1.2%+2dgt) 40mA 400mA (1.5%+3dgt) 4A 10A ±(2.0%+3dgt)
	frequency	10Hz–10MHz	0.1% +3dgt
	capacitance	40nF, 400nF, 4µF, 40µF, 100µF	40nF (3%+10dgt) 400nF, 4µF, 40µF (3%+5dgt) 100µF (4%+5dgt)
	resistance	400, 4K, 40K, 400K, 4M, 40M	400 4M (1.2%+2dgt) 4K 40K 400K (1.0%+2dgt) 40M (1.5%+2dgt)
	diode test	yes	–
	continuity	yes	–
	CAT rating	III 600V, II 1000V	–



10 Function Digital Multimeter

This auto range digital multimeter features a large backlit display screen and non-contact voltage detection. It has functions capable of testing for AC & DC volts, AC current, DC current, resistance, diode testing, continuity (audibly), capacitance, frequency, non-contact AC voltage detection and many other features. Additionally this multimeter is ergonomically styled with rubber gripping areas and is benchmark proven for durability against impact, heat, vibration and crush.

part no.	specifications	range	accuracy
19006600	DC voltage	40mV/400mV/4V/ 40V/400V/1000V	40mV (1.2%+5dgt) 400mV (0.8%+3dgt) 4V 40V 400V (0.8%+1dgt) 1000V (1.0%+3dgt)
	AC voltage	40mV/400mV/4V/ 40V/400V/750V	40mV (1.2%+5dgt) 4V 40V 400V (1.0%+ 5dgt) 400mV 750V (1.2%+5dgt)
	non contact AC voltage	80–1000V AC	–
	DC amps	400µA/4000µA/40mA/ 400mA/4A/10A	400µA 4000µA (1.0%+2dgt) 40mA 400mA (1.2%+3dgt) 4A 10A (1.5%+5dgt)
	AC amps	400µA/4000µA/40mA/ 400mA/4A/10A	400µA 4000µA (1.2%+2dgt) 40mA 400mA (1.5%+3dgt) 4A 10A ±(2.0%+3dgt)
	resistance	400Ω/4K/40K/400K/4M/40MΩ	400 4M (1.2%+2dgt) 4K 40K 400K (1.0%+2dgt) 40M (1.5%+2dgt)
	capacitance	40nF/400nF/4µF/40µF/ 400µF/4000µF	40µF (3.0%+10dgt) 400µF 4µF 40µF (3.0%+5dgt) 400µF 4000µF (4.0% +5dgt)
	frequency	100Hz–10MHz	0.1%+3dgt
	diode test	yes	–
	continuity	yes	–
CAT rating	IV 600V, III 1000V	–	

specialty testers



Scan for pricing or go to www.delcity.net/catalogpricing



True RMS 10 Function Digital Multimeter



Review data with one of the largest backlit display screens and non-contact voltage detection. This multimeter has functions capable of testing for AC & DC volts, AC current, DC current, resistance, diode testing, continuity (audibly), capacitance, frequency, non-contact AC voltage detection and many other features including True TRMS test proven for durability against impact, heat, vibration and crush. Operates from one 9 volt battery.

part no.	specifications	range	accuracy
19006650	DC voltage	40mV/400mV/4V/ 40V/400V/1000V	40mV (1.2%+5dgt) 400mV (0.8%+3dgt) 4V 40V 400V (0.8%+1dgt) 1000V (1.0%+3dgt)
	AC voltage	40mV/400mV/4V/40V/ 400V/750V	40mV (1.2%+5dgt) 4V 40V 400V (1.0%+ 5dgt) 400mV 750V (1.2%+5dgt)
	non contact AC voltage	80–1000V AC	–
	DC amps	400uA/4000uA/40mA/ 400mA/4A/10A	400uA 4000uA (1.0%+2dgt) 40mA 400mA (1.2%+3dgt) 4A 10A (1.5%+5dgt)
	AC amps	400uA/4000uA/40mA/ 400mA/4A/10A	400uA 4000uA (1.2%+2dgt) 40mA 400mA (1.5%+3dgt) 4A 10A ±(2.0%+3dgt)
	resistance	400Ω/4K/40K/400K/ 4M/40MΩ	400 4M (1.2%+2dgt) 4K 40K 400K (1.0%+2dgt) 40M (1.5%+2dgt)
	capacitance	40nF/400nF/4uF/40uF/ 400uF/4000uF	40uF (3.0%+10dgt) 400uF 4uF 40uF (3.0%+5dgt) 400uF 40000uF (4.0% +5dgt)
	frequency	100Hz–10MHz	0.1%+3dgt
	diode test	yes	–
	continuity	yes	–
CAT rating	IV 600V, III 1000V	–	



Pocket Pro® Digital Multimeter



This auto ranging pocket-sized multimeter tests both AC and DC voltages. It is overload protected on all ranges and includes a booklet type case. It can test resistance, continuity, diodes and has an automatic power off. Operates from (2) LR44 batteries.

part no.	specifications	range	accuracy
19102211	DC voltage	400mV/4V/40V/400V/450V	0.5%+3dgt
	AC voltage	400mV/4V/40V/400V/450V	1%+3dgt
	resistance	400Ω/4K/40K/400K/ 4000K/40MΩ	400–4000K (1%+3dgt) 40M (2.0%+3dgt)
	diode test	yes	–
	continuity	yes	–



5 Function Analog Multimeter

Check up to five different functions with this manual range multimeter. It's capable of testing AC & DC voltages, DC current, resistance and decibels. The analog multimeter provides accurate needle deflection. The compact, lightweight design allows for easy carrying in the toolbox. Operates from one AA battery.



Scan for pricing or go to www.delcity.net/catalogpricing

part no.	specifications	range	accuracy
19200382	DC voltage	0-10/50/150/300V	4.0%
	AC voltage	0-10/50/150/300V	5.0%
	DC current	0-0.5/50/150 mA	4.0%
	resistance	0-1MΩ	4.0%
	decibels	yes	-20dB to +56dB
	CAT rating	II 300V	-



Six Function, 19 Range Multimeter

Tests AC/DC voltage, DC current, continuity, resistance, decibels and batteries. Fuse overload protection, except for 10 amp. Includes two safety test leads, instruction manual and battery. Audible continuity check.

part no.	specifications	range
991070	DC voltage	2.5, 10, 50, 250, 1000 volts
	AC voltage	10, 50, 250, 750 volts
	DC current	5, 50, 250mA, 10 amps
	resistance	10 megohms
	decibels	-8dB to +62dB on AC volt range
	battery test	1.5 V AA and 9 V
	accuracy	DC voltage ±4%, AC voltage ±5% resistance ±4% arc of full scale
	sensitivity	20,000 Ohms/V DC, 8000 Ohms/V AC



Five Function, 19 Range Digital Multimeter

Tests AC/DC voltage, DC current, resistance and diode check. Easy to read LCD with 31/2 digit display. Fuse overload protection, except for 10 amp. Battery is included.

part no.	specifications	range
991050	DC voltage	200m, 2000m, 20, 200, 1000 volts
	AC voltage	200, 750 volts
	DC current	10 amps
	resistance	2 megohms
	accuracy	DC voltage ±.7%, AC voltage ±1.2% DC current ±1.5%, resistance ±1%



Scan for pricing or go to www.delcity.net/catalogpricing



13 Function, 39 Range Automotive Digital Multimeter

3.5 digital LCD display with a max reading of 3200. Overload protection on all ranges. Rubber holster with built-in tilt stand. Includes test leads, batteries and temperature probe. Tach and Dwell functions. Computer safe.

part no.	specifications	range
992220	DC voltage	320mV/3.2/32/320/600V
	AC voltage	3.2/32/320/600V
	DC/AC current	320u/3200uA/32m/320mA/10A
	frequency	320/3200/32KHz
	resistance	320/3.2K/32K/320K/3.2M/32 ohm
	RPM (tach)	600–3200, 6000–12000RPM
	dwell ranges	4 cyl 0–90°, 5 cyl 0–72°, 6 cyl 0–60°, 8 cyl 0–45°



6 Function Digisnap™ Digital Snap-Around



The oversized, tear drop shape jaws allow for non-contact current readings of 2000A AC/DC. Features include a data hold capability to maintain reading on display, min/max function to hold either minimum or maximum reading on the display and peak hold function to display in-rush current. The auto power off helps save battery life. Includes carrying case and operates on AAA batteries.

part no.	specifications	range	accuracy	resolution	overload protection
19101870	DC voltage	400/1000	±1%	100mV	1200V AC/DC
	AC voltage	400/750V	1.5%	100mV	1200V AC/DC
	DC current	400/2000A	±1.5%rdg ± 2dgt	100mA	2400A AC/DC
	AC current	400/2000A	1.5%±2dgt (0–1000A) 3%±2dgt (1001–2000A)	100mA	2400A AC/DC
	resistance	400/4000Ω	±1.5%rdg ± 2dgt	100mΩ	600V AC/DC
	cont buzzer	0–600 Ohms	buzzer sounds @ 100 ohms or less	–	–
	CAT rating	III 1000V, IV 600V	–	–	–



True RMS 6 Function Digisnap™ Digital Snap-Around



The oversized, tear drop shape jaws allow for non-contact current readings of 1000A. Features include a data hold capability to maintain reading on the display, min/max function to hold either minimum or maximum reading on the display and peak hold function to display in-rush current. The auto power off helps save battery life. Includes a carrying case and operates on AAA batteries.

part no.	specifications	range	accuracy	resolution	overload protection
19102365	DC voltage	40/400/1000	±1%rdg ± 2dgt	10mV	1200V AC/DC
	AC voltage	40/400/750V	2.0%	100mV	1200V AC/DC
	DC current	400/2000A	±1.5%rdg ± 2dgt	100mA	2400A AC/DC
	AC current	400/2000A	1.5%± 3dgt (0–1700A)/ 3.5%±3dgt (1701–2000A)	100mA	2400A AC/DC
	resistance	400/4000Ω	±1.5%	100mΩ	600V AC/DC
	cont buzzer	0–600 Ohms	buzzer sounds @ 100 ohms or less	–	–
	CAT rating	II 750VAC/ 1000DC, III 600V	–	–	–



True RMS 10 Function Digital Snap-Around

The precise true RMS circuitry incorporates an integrated non-contact voltage detection. It can read up to 1000A. Features include a data hold capability to maintain reading on display, min/max function to hold either minimum or maximum reading on the display and peak hold function to display in-rush current. Capacitance and temperature measurement are also included. The auto power off helps save battery life. Includes carrying case and operates on AAA batteries.



Scan for pricing or go to www.delcity.net/catalogpricing

part no.	specifications	range	accuracy	resolution	overload protection
19100989	DC voltage	600mV/6/60/600V	1% ±3dgt	100µV	720V AC/DC
	AC voltage	6/60/600V	1.5% ± 4dgt	1mV	720V AC/DC
	DC current	600/1000A	±1.5%rdg ± 5dgt	100mA	1200A AC/DC
	AC current	600/1000A	2%±5dgt	100mA	1200A AC/DC
	resistance	600/6K/60K/600K/6M/60MΩ	1% ±5dgt (600~6MΩ) 5% ±8dgt (6M~60M)	100mΩ	600V AC/DC
	frequency	10/100/1000/10K	0.5%±5dgt	—	—
	diode test	yes	—	—	—
	cont buzzer	0–600 Ohms	buzzer sounds @ 100 ohms or less	—	—
	capacitance	40nF–4000µF	2.5%±20dgt (400nF–40µF) NA (40nF, 40µF–4000µF)	—	—
	temperature	50° to 700°C/ 58° to 1292°F	°C ±5°/ °F±9°	—	—
CAT rating	IV 600	—	—	—	



7 Function Digital Snap-Around

This digital meter is rated for 600A, non-contact current readings. The integrated snap-around jaw also detects voltage without contact. Readings can be held on the display with min/max function. The auto power off helps save battery life. Includes carrying case and operates on AAA batteries.

part no.	specifications	range	accuracy	resolution	overload protection
19100927	DC voltage	600mV/6/60/600V	1% ±3dgt	100µV	720AC/DC
	AC voltage	6/60/600V	1.3% ± 4dgt	1mV	720AC/DC
	AC current	600A	1.5%rdg ± 5dgt	100mA	720AC
	resistance	600/6K/60K/600K/6M/60MΩ	1% ±5dgt (600~6MΩ) 5% ±8dgt (6M~60M)	100mΩ	600AC/DC
	frequency	10/100/1000/10K	0.5%	—	—
	diode test	yes	—	—	—
	cont buzzer	0–600 Ohms	buzzer sounds @ 100 ohms or less	—	—
	CAT rating	IV 600	—	—	—



Line Splitter

For use with any clamp meter. It features a 1X and 10X measuring capability. Probe slots for voltage measurement.

part no.	specifications	range
19107100	operational voltage	120V AC
	AC current	15A
	frequency	50/60Hz



Scan for pricing or go to www.delcity.net/catalogpricing



6 Function Digital Snap-Around



Tester incorporates a lightweight design and an integrated non-contact voltage detection capable of 400A current reading. Features include a data hold capability to maintain reading on display and auto power shut-off to help save battery life. Includes carrying case and operates on AAA batteries.

part no.	specifications	range	accuracy	resolution	overload protection
19103386	DC voltage	400/600V	1.5%	100mV	720VAC/DC
	AC voltage	400/600V	2%	100mV	720VAC/DC
	DC current	40/400	3%±8dgt (0-40A) 4%±6dgt (40-400A)	10mA	480A
	AC current	40-400	3%±8dgt (0-40A) 4%±6dgt (40-400A)	10mA	480A
	resistance	400/4000Ω	2%	100mΩ	300VAC/DC
	cont buzzer	0-600 Ohms	buzzer sounds @ 100 ohms or less		
	CAT rating	II 600, III 300V AC	-	-	-



5 Function Digital Snap-Around



Tester incorporates an integrated non-contact voltage detection capable of 400A current reading. Features include a data hold capability to maintain reading on display and auto power shut-off to help save battery life. Includes carrying case and operates on AAA batteries.

part no.	specifications	range	accuracy	resolution	overload protection
19105526	DC voltage	400/600V	1.5%	100mV	720VAC/DC
	AC voltage	400/600V	2%	100mV	720VAC/DC
	AC current	40-400	2%	10mA	480A
	resistance	400/4000Ω	2%	100mΩ	300VAC/DC
	cont buzzer	0-600 Ohms	buzzer sounds @ 100 ohms or less		
CAT rating	II 600, III 300V AC	-	-	-	



Analog Clamp Meter



This digital meter is rated for 600A, non-contact current readings. The large viewing window allows for accurate readings. Data can also be held to keep reading in place. Broad frequency response (50-400Hz). Operates on one AA battery.

part no.	specifications	range	accuracy
19101900	AC voltage	150/300/600V	±3% of FS
	AC current	6/20/60/200/600A	±3% of FS
	resistance	2K	±3% of scale length



Scan for pricing or go to www.delcity.net/catalogpricing



Wire Tracker™ Wire Tracer



A must-have tester for audio/video installers and data com technicians. A multi-purpose wire tracer for identifying wires such as coax, CAT 5, speaker, phone, or any non-energized (non-live) wires, adapter plugs include: RJ-45, RJ-11, coax, automotive fuse blade, and insulated clamps. The adjustable sensitivity positively identifies a single wire when multiple wires are routed in close proximity. Auto off function included with transmitter to save battery life. Audible and visual indication. Operates from (2) AAA batteries (transmitter) and (4) LR44 batteries (receiver).

part no.	specifications	range
19064854	audible	yes
	visual	yes
	receiver storage	yes
	belt clip	yes
	tracer	yes



Cable Test Plus

Test both twisted pair and coax cable installations with the cable test plug. The remote UTP/STP and coaxial tests jacks, detecting opens, shorts, miswires and reversals. Both tester and in T568A and T568B configurations. The rubber overmold construction provides a comfortable grip and longer life. The tester and remote conveniently snap together for transportation and storage. Wiring reference chart included.

part no.	specifications	range
19065332	continuity, opens, and miswires	yes
	shorts & reversals	yes
	coax	yes
	shield continuity	yes



Dual Telephone Line Tester

Tests the status of single or dual phone lines. The tri-color LED's indicate line status and flexible lead comes with standard RJ11 phone plug.

part no.	specifications	range
19065219	pocket clip	yes
	visual indication	yes
	single & dual line test	yes

RV accessories

Cordsets



Manufactured with the highest, marine-grade quality material whose unique features are not found on other cordsets. The cordsets are constructed from heavy-duty, super flexible, 10-gauge marine-grade cable that is rated to 30 amps. They feature watertight, molded plugs and connectors for added safety and durability and nickel plated contacts to resist corrosion. All models include a standard threaded ring for use on ordinary threaded inlets. All cordsets are UL and CSA rated and feature a 5-year manufacturer warranty.



25SPP.RV

part no.	description	style
25SPP.RV	25' 125V @ 30A power cord plus cordset	RV
30SPP.RV	30' 125V @ 30A power cord plus cordset	RV
50SPP.RV	50' 125V @ 30A power cord plus cordset	RV
19014100	25' 125/250V @ 50A power cord plus cordset	RV
19012100	50' 125V @ 30A power cord plus cordset	marine
19012103	50' 50A, 125/250V power cord plus cordset	marine

Right Angle Cordsets

Allow for right angle detachable connections to provide minimal cordset protrusion from inlets for more clearance in tight RV spaces. It is manufactured with the highest, marine-grade quality material whose unique features are not found on other power cords. The cordset is constructed from heavy-duty, super flexible, 10-gauge marine-grade cable that is rated to 30 amps. It features watertight, molded plugs and connectors for added safety and durability and nickel plated contacts to resist corrosion. The right angle cordset includes a standard threaded ring for use on ordinary threaded inlets.



30RPCRV

part no.	description
30RPCRV	30A right angle cordset

Inlets

Industry standard power hook-ups for RVs. They all feature robust construction and are manufactured from corrosion resistant material to ensure longevity. Inlets are offered in two basic styles, stainless steel and glass-filled nylon. Stainless steel inlets are solid cast marine-grade 316 stainless steel and include a heavy-duty cap strap for strength and durability. The nylon inlets provide more selection.



150BBI.RV

part no.	description	rating
150BBI.RV	RV round, black	15A @ 125V
150BBIW.RV	RV round, white	15A @ 125V
200BBI.RV	RV round, black	20A @ 125V
200BBIW.RV	RV round, white	20A @ 125V
303SSEL-BRV	RV round, stainless steel	30A @ 125V
304EL-BRV	RV square contoured , white	30A @ 125V
301ELRV	RV round, white	30A @ 125V
19014102	RV square, white	50A @ 125/250V
19012102	marine square, white	50A @ 125

Pigtail Adapters

Allow you to connect from your RV receptacle to one inlet or equipment of dissimilar power configuration.



104SPPRV

part no.	description	rating	
		to	from
104SPPRV	locking female to straight blade male	125V @ 30A	125V @ 15A
150SPPRV	3-pole, 4-wire locking female to male	125/250V @ 50A	125V @ 15A
1PCMRV	locking female to 2-pole, 3-wire male	125V @ 30A	125V @ 30A
124ARV	locking female to 2-pole, 3-wire male	125/250V @ 50A	125V @ 30A
124ARV-25	locking female to 2-pole, 3-wire male, 25'	125/250V @ 50A	125V @ 30A



Scan for pricing or go to www.delcity.net/catalogpricing



1RPCRV

Right Angle Adapter

Converts your existing 30A detachable power cord from a straight connection to a right angle connection. Its connection provides minimal cordset protrusion from inlets for more clearance in tight RV spaces. The GripLock™ handle design allows for easy hook-up and correct blade alignment with the inlet, even in darkness. The right angle adapter includes sealing collar for maximum moisture protection between connector and cordset.

part no.	description	rating	
		to	from
1RPCRV	locking female to locking male	125V @ 30A	125V @ 30A



Scan for pricing or go to www.delcity.net/catalogpricing

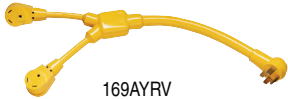

169AYRV

"Y" Adapters

Allow you to split one 50A 125/250V 3-Pole, 4-Wire pedestal receptacle between two 30A 125V female inlets.

part no.	description	rating		Style
		to	from	
169AYRV	"Y" adapter, female 2-pole, 3-wire, to 3-pole, 4-wire	2 - 125V @ 30A	125/250V @ 50A	RV
19012108	"Y" adapter, female to male	2 - 125V @ 50A	125/250V @ 50A	RV
19012117	"Y" Adapter, 50A, 125/250V Male to 2-30A Female (1 MIN)	2 - 125V @ 50A	125/250V @ 50A	marine
19012111	Reverse "Y" Adapter, 50A, 125/250V Male to 2-30A Female (1 MIN)	125/250V @ 50A	2 - 125V @ 30A	marine



126A

Generator Adapters

Allow you to connect a standard RV cordset to different types of electrical receptacles found on portable generators. These adapters are manufactured to be weather resistant and durable. Installation is easy. Simply attach the female side of the adapter to the male plug of the cordset and plug the male adapter to the portable generator receptacle.

part no.	description	rating	
		to	from
126A	generator adapter, male 3 prong, straight blade	female: 125V @ 30A	male: 125V @ 20A
127A	generator adapter, male 3 prong, locking	female: 125V @ 30A	male: 125V @ 20A
128A	generator adapter, male 4 prong, locking	female: 125V @ 30A	male: 125/250V @ 20A
125A	generator adapter, male 3 prong, locking, UL approved	female: 125V @ 30A	male: 125V @ 30A
172ARV	1' generator adapter, male 4 prong, locking	female: 125V @ 30A	male: 125/250V @ 30A



Straight Blade Adapters

Allow you to connect two dissimilar power configurations. They feature an extra wide grip handles and 10/3 heavy-duty marine-grade cable. Color-coded plugs and connectors take the guesswork out of connecting the correct electrical ends. Straight blade adapters are not water resistant. 5-year manufacturer warranty.

part no.	description	rating	
		to	from
1530ARV	straight blade adapter	female: 125V @ 30A	male: 125V @ 15A
3015ARV	straight blade adapter, male 2-pole, 3-wire	female: 125V @ 15A	male: 125/250V @ 30A
5030ARV	straight blade adapter, male 3-pole, 4-wire	female: 125V @ 30A	male: 125/250V @ 50A



305CRV

Female Connectors



Designed to be used with power inlets from ParkPower®. They are manufactured from high quality, corrosion resistant material for long life. Connectors are UL and CSA rated.

part no.	description	rating
305CRV	female connector	125V @ 30A
6364CRV	female connector	125/250V @ 50A
5369CR	female connector	125V @ 20A

RV accessories

Male Plugs

Designed for use with 10 gauge, 30 amp RV cable. They are constructed of extremely tough, glass-filled nylon material for weather resistance. The wide grip handle allows users to safely and easily remove the plug from the outlet. A cord strain relief firmly secures the cable connection and prevents wire disconnects over time. Matches standard RV outlets. Meets NEMA standard TT-30P.



30MPRV

part no.	description	rating
30MPRV	right angle male replacement plug	125A @ 30A
19012106	straight, 3-pole, 4-wire	125/250V @ 50A



Power Pedestal Electrical Outlet Receptacle

This 50 Amp power pedestal 125/250V outlet receptacle is designed to replace or add an additional outlet in a dockside or campground power pedestal. The outlet can be used in most manufacturers' power pedestals.

part no.	description	rating
19012112	dockside receptacle, 3-pole, 4-wire	125/250V @ 50A



103RV

Weatherproof Covers

Protect the connection of a female connector and an RV inlet. The Easy Lock™ system quickly locks the cover to the inlet in just 1/8 of a turn. The threaded sealing ring will fit a standard threaded inlet. Both covers will work with ParkPower® 305CRV.

part no.	description	rating
103RV	weatherproof cover w/sealing ring	125V @ 30A
103ELRV	weatherproof cover w/Easy Lock™ sealing ring	125V @ 30A



12VRCRV

12 Volt Power Products

Manufactured from corrosion resistant marine-grade material. These products feature the unique interconnecting system that securely locks the plug and receptacle, providing a positive connection and moisture resistant seal. This system is exclusive to ParkPower®. The plug and receptacle feature optimized metal connection points of maximum connectivity. All products are compatible with standard 12V plugs and receptacles.

part no.	description
12VRCRV	deluxe 12 volt receptacle
12VADRV	deluxe 12 volt dual outlet cord
12VPGRV	deluxe 12 volt plug
12VXTRV	deluxe 12 volt extension cord
12VPKRV	deluxe 12 volt receptacle & plug
12BKT	SealLink® mounting bracket
19012104	deluxe 12V snap-in receptacle
19012107	deluxe 12V receptacle with old style ring
19012113	deluxe 12V receptacle and mounting pad



TV97

TV Outlet, USB Port And HDTV/Internet Cable Cord

Provides all the necessary components to stay connected while getting not too far away from it. The cable TV outlet has a spring-loaded lift cover, a weatherproof closure and fits FS and FD boxes. The USB port features a USB cable with weatherproof cap and includes 6 feet of USB port cable. The HDTV/Internet cable has weatherproof F-type connections on both ends. The 50 foot yellow cable cord is rated to 75 ohms, with a 3GHz, RG6 quad shield and gasket sealed.



USBA6

part no.	description
TV97	cable TV outlet
USBA6	USB port
TVHDRV	HDTV/internet cable



30ARVKIT

Conversion Kit

An easy way to upgrade your existing, hard-wired RV. It converts the 30A hard-wired power hook-up, to a detachable hook-up. The conversion kits features the Easy Lock™ system and is manufactured from corrosion resistant material. Kit includes the following ParkPower® items: inlet 304EL-BRV, 30A female connector 305CRV, comfort grip 103RV weatherproof cover, mounting adapters and gaskets, metal ring cover, electrical box and strain relief.

part no.	description	rating
30ARVKIT	conversion kit	30A



Scan for pricing or go to www.delcity.net/catalogpricing



CURT16245

Q-Series 5th Wheel Hitches

Feature a spherical axial bearing that ensures smooth, quiet towing. The dual jaws provide a 360° pin contact to reduce clanking and the coupling indicator is visible from vehicle cab. Other features include: self-aligning head; lockable; two pin head removal; mounts to industry standard rails; includes plastic lube plate and carbide powder coat finish. 10-year, limited manufacturer's warranty.

part no.	description	towing capacity (lbs)	height
CURT16245	5th wheel	24,000	13"–17"
CURT16246	5th wheel and rails*	24,000	13"–17"
CURT16545	5th wheel head (use w/roller)	24,000	N/A
CURT16546	5th wheel head and roller	24,000	17.5"–21.5"
CURT16646	5th wheel head, roller & rails*	24,000	17.5"–21.5"
CURT16130	5th wheel	20,000	13"– 17"
CURT16131	5th wheel & rails*	20,000	13"–17"
CURT16530	5th wheel head (use w/roller)	20,000	N/A
CURT16536	5th wheel head & roller	20,000	17.5"–21.5"
CURT16636	5th wheel head, roller & rails*	20,000	17.5"–21.5"

* rail part # CURT16200



Scan for pricing or go to www.delcity.net/catalogpricing



CURT16115

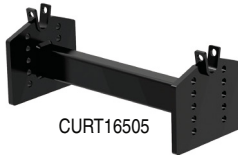

CURT16505

E-Series 5th Wheel Hitches

Feature a dual pivot head and offer the ease of single handle operation. Position height with four point adjustment. Other features include: two pin head removal; 10° lateral movement; anti-rattle skid plate; mounts to industry standard rails and carbide powder coat finish. 5-year, limited manufacturer's warranty.

part no.	description	towing capacity (lbs)	height
CURT16115	5th wheel	16,000	13" to 17"
CURT16116	5th wheel & rails*	16,000	13" to 17"
CURT16515	5th wheel head (use w/roller)	16,000	N/A
CURT16516	5th wheel head & roller	16,000	14" to 17"
CURT16616	5th wheel head, roller & rails*	16,000	14" to 17"

* rail part # CURT16200

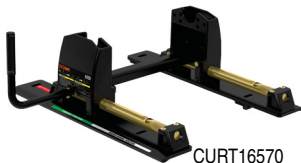

CURT16570

5th Wheel Rollers

Help eliminate clearance problems during slow-speed turns with non-binding rods. It provides 12" of travel from front to back. Other features include: true rolling units; mounts to industry standard rails and carbide powder coat finish. 10-year (24,000 and 20,000 lb models) and 5-year (16,000 lb model) limited manufacturer's warranty.

part no.	description	gross towing weight (lbs)
CURT16570	5th wheel roller	24,000
CURT16550	5th wheel roller	20,000
CURT16560	5th wheel roller	16,000
CURT16505	adapts 16K head (CURT16116 or CURT16115) to CURT rollers	N/A

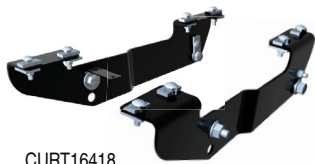

CURT16418

Custom 5th wheel bracket kits

Allows you to get your 5th wheel hitch properly mounted to your vehicle. These kits help reduce overall installation time by 50%. Other features include: reduces or eliminates drilling; for use with CURT16104/CURT16204 rails; mounting hardware included.

part no.	description
CURT16412	2007–2012 GM 5th wheel bracket kit*
CURT16418	1997–2007 GM 5th wheel bracket kit*

* Use with base rails CURT16104 or CURT16204.

RV accessories

Universal 5th wheel base rails

Allows for universal hitch installation. Available in either glossy or carbide finish. These base rails can be used with all Curt and competitive 5th wheels, rollers, bent plate goosenecks and Spyder goosenecks.

part no.	description	finish
CURT16100	2 universal 5th wheel base rails (includes rails, brackets & hardware)	gloss
CURT16104	2 universal 5th wheel base rails only (brackets & hardware kit not included)	gloss
CURT16200	2 universal 5th wheel base rails (includes rails, brackets & hardware)	carbide
CURT16204	2 universal 5th wheel base rails only (brackets & hardware kit not included)	carbide
CURT16101	universal brackets and hardware	gloss

* Some vehicles require custom brackets

RV Trailer Hitches

Feature weathertite construction, which prevents rusting from the inside out by sealing the main body of the hitch. The receiver tube has an open back end to allow for easy cleaning and for dirt and moisture to pass through and not get trapped as is common with other brands of hitches. They can be adjusted to fit the frame rails from 51" to 72". Hitch balls and mounts sold separately.

part no.	description	GTW/TW lbs	WD lbs
CURT13701	fits frames up to 51" wide	5,000/500	6,000/600
CURT13702	fits frames up to 51" wide	5,000/500	6,000/600
CURT13703	fits frames up to 72" wide	3,500/350	N/A

RV Bumper Hitches

Easily bolts to your square bumper channel. Ideal for not only RVs, but also towable campers. Hardware included.

part no.	description	GTW/TW lbs
CURT19100	fits 4" square channel bumper	3,500/350
CURT19101	fits 2" square channel bumper	3,500/350

Weight Distribution and Sway Control Bars

Allow for better control over braking and steering when hauling heavy loads. Powder coat finish helps resist corrosion and rust. Not to be used with surge brakes.

part no.	description/style	GTW/TW lbs
CURT17300	trunnion bar	10,000/600
CURT17301	trunnion bar	10,000/800
CURT17302	trunnion bar	10,000/1,000
CURT17330	short trunnion bar	10,000/600
CURT17331	short trunnion bar	10,000/800
CURT17332	short trunnion bar	10,000/1,000
CURT17000	round bar	10,000/600
CURT17001	round bar	10,000/800
CURT17002	round bar	10,000/1,000
CURT17200	sway control kit	—

X5 5th Wheel Adapters

Allow a quick changeover from gooseneck to 5th wheel rail in minutes. It drops into Curt double-lock, providing a secure 5th wheel base rails.

part no.	description	GTW/TW lbs
CURT16210	round shank, Curt products	20,000
CURT16310	square shank, competitive brands	20,000



Scan for pricing or go to www.delcity.net/catalogpricing

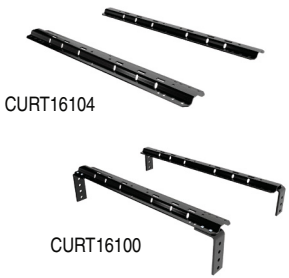



CURT45534

The Towing Starter Kit

Everything you need to begin towing. Both kits include one of the following: ballmount, trailer ball, hitch lock, rubber cover and sturdy reusable case for 2" x 2" receiving tubes.

part no.	description	GTW/TW lbs
CURT45534	2" ball kit, 2" drop, 3/4" rise	7,500/750
CURT45554	2" ball kit, 4" drop, 2" rise	7,500/750



Scan for pricing or go to www.delcity.net/catalogpricing



905700010

Kwiekee Battery Trays

Provide easy pull-out, so there is no need to twist, bend or contort the body to gain access to your batteries. Easily load, maintain, service and access the items you need with these heavy-gauge trays. Ball and roller bearing slides provide smooth operation. A safety latch mechanism locks slide for safe storage. Tray comes assembled and ready to bolt in.

part no.	description	weight capacity (lbs)	inside dimensions	outside dimensions
905700010	standard-duty battery tray	130	14"W x 13"D	15-1/2"W x 15-1/8"D x 3-3/8"H
905701010	standard-duty battery tray	130	13"W x 14-1/4"D	14-9/16"W x 15-1/2"D x 3-5/16"H
905702010	standard-duty battery tray	130	14"W x 13"D	15-1/2"W x 15-1/8"D x 2-3/4"H
905703010	standard-duty battery tray	130	14"W x 12-1/8"D	15-3/8"W x 13"D x 2-1/2"H
905703013	standard-duty battery tray	130	7-3/4"W x 12-5/8"D	9"W x 13-1/2"D x 2-1/2"H
905722000	standard-duty battery tray	130	13"W x 15-1/8"D	14-9/16"W x 16-3/8"D x 3-3/8"H
905731010	standard-duty battery single pack	130	—	12-1/4"W x 15-1/2" x 2-1/2"
905705000	heavy-duty battery tray	200	13-3/8"W x 21-3/8"D	15-13/16"W x 24"D x 3-3/16"H
905706000	heavy-duty battery tray	200	14-1/4"W x 14-1/4"D	16-9/16"W x 16-13/16"D x 3-3/16"H
905728000	heavy-duty battery tray -carriage	230	21"W x 10-1/4"D	23-13/21"W x 13"D x 5-1/4"H
905707000	heavy-duty battery tray	200	22-7/8"W x 22-7/8"D	25-1/8"W x 24-13/16"D x 3-3/16"H
905708000	heavy-duty battery tray	200	20"W x 13-7/8"D	22-1/4"W x 15-1/4"D x 3-1/16"H
905709000	heavy-duty battery tray	200	14-3/8"W x 21"D	16-15/16"W x 22-5/8"D x 3-3/16"H
905711000	heavy-duty battery tray	200	22-1/8"W x 17-1/8"D	24-9/16"W x 18-5/16"D x 3-3/16"H
905714000	heavy-duty battery tray	200	15-1/8"W x 16-9/16"D	17-1/8"W x 18-1/16"D x 3-7/8"H
905723000	heavy-duty battery tray	200	21"W x 13-7/8"D	23-7/16"W x 15-3/32"D x 3-3/16"H
908323000	battery tray strap		33"	33"

RV accessories

Kwieke Refrigerator Trays

Make access to freezer and extra refrigerator storage more convenient. The ball and roller bearings provide smooth and easy glides for access. An opening in the bottom of the tray accommodates drainage and circulation. A safety latch mechanism locks slide for safe storage. Tray comes assembled and ready to bolt in.



905570000

part no.	description	weight capacity (lbs)	inside dimensions	outside dimensions
905570000	refrig/freezer tray – wide	200	31-1/2"W x 20-1/8"D	33-3/4"W x 28-1/16"D x 3-11/16"H
905571000	refrig/freezer tray – deep	200	14-1/2"W x 25-1/2"D	16-3/4"W x 28-1/16"D x 3-11/16"H
905572000	refrig/freezer tray – wide	200	25-1/4"W x 14-5/8"D	27-1/2"W x 18-1/16"D x 3-11/16"H

Kwieke LP Tank Trays

Make easy access for refilling or changing your LP tanks. Each has a smooth ball and roller bearing for effortless tray actuation. The powder coat finish helps protect the heavy-gauge steel construction and provides an aesthetically pleasing appearance. An adjustable center rod secures LP tanks. Tray comes assembled and ready to bolt in.

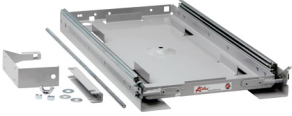

905563000

part no.	description	tank capacity (gal)	inside dimensions	outside dimensions
905563000	LP tank tray-front-to-back	200 lbs–7 gal	11-3/8"W x 24"D	13-11/16"W x 25-3/16"D x 2-1/4"H
905565000	LP tank tray-front-to-back	200 lbs–7 gal	11-3/8"W x 24"D	13-11/16"W x 25-3/16"D x 2-1/4"H

Kwieke Cargo Tray Slides - Super Slides

Designed to provide extra storage drawers. These slides fit almost any sub-floor compartment. The fixed position, heavy-duty roller bearings provide smooth operation. A spring loaded latch locks the slide in three positions. Width is defined by the size of the compartment. Super Slides ship with side slide assemblies and end pieces. Floor and carpeting not included. Trim kit is optional.



905853002

part no.	description	weight capacity (lbs)	length
905853002*	1-way super slide – aftermarket package	1,000	36"
905850002*	1-way super slide – aftermarket package	1,000	42"
905851002*	1-way super slide – aftermarket package	1,000	48"
905852002*	1-way super slide – aftermarket package	1,000	54"
905855002*	1-way super slide – aftermarket package	1,000	60"
905856002*	1-way super slide – aftermarket package	1,000	70"
905849911	90" power slide	1,000	90"
905858002*	2-way super slide, U-channel	1,000	80"
905857002*	2-way super slide, "L" brackets	1,000	90"
905857011	2-way super slide, left hand assembly only	1,000	90"
905857012	2-way super slide, right hand assembly only	1,000	90"

* trim kit included

Kwieke Cargo Tray Slides - Super Slides II

Build the storage drawer to fit your needs. Corrosion-resistant roller bearing action, "big load" weight capacity, and narrow sides make these slides a great storage solution. The Super Slide II handles up to 800 lbs in compartment depths from 36" to 90". Trim kit is required.



905893000

part no.	description	weight capacity (lbs)	length
905893000	1-way pull super slide II	800	36"
905890000	1-way pull super slide II	800	42"
905891000	1-way pull super slide II	800	48"
905892000	1-way pull super slide II	800	54"
905895000	1-way pull super slide II	800	60"
905849800	2-way pull super slide II	800	80"
90584990	2-way pull super slide II	800	90"



Scan for pricing or go to www.delcity.net/catalogpricing

Kwikee Cargo Tray Slides - Heavy-Duty Slides

A variety of depths available and the ability to create the exact width you need by bolting in the plywood platform. Cover with carpet, rubber matting or vinyl and slide is complete. The industrial grade ball-bearing slide provides a smooth action and support with 100% pull-out strength. You determine the plywood width per your application. Trim kit is optional.



905901000

part no.	description	weight capacity (lbs)	length	latches
905901000	heavy-duty slide assembly	200	12"	right side
905902000	heavy-duty slide assembly	200	16"	right side
905916000	heavy-duty slide assembly	200	22"	right side
905966000	heavy-duty slide assembly	400	22"	right side
905918000	heavy-duty slide assembly	200	30"	right side
905968000	heavy-duty slide assembly	300	30"	right side
905988000	heavy-duty slide assembly	450	30"	both sides



Scan for pricing or go to www.delcity.net/catalogpricing



905800010

Ball Slide Rails

Replace existing or damaged slides. They are extremely durable slide kits and feature a ball bearing slide for smooth and effortless actuation.

part no.	description	weight capacity (lbs) per pair	depth
905800010	ball slide rail – pair	200	12"
905801000	ball slide rail – sold individually	200	16"
905802000	ball slide rail – sold individually	200	22"
905803000	ball slide rail – sold individually	200	26"
905804000	ball slide rail – sold individually	200	30"
905806000	ball slide rail – sold individually	300	22"



905860000

Kwikee Cargo Tray Trim Kits - Super Slide Trim

These trim kits are specifically designed to be used with Super Slides and Heavy-Duty Slides.

part no.	description
905860000	35-3/4" Trim Pieces
905861000	48" Trim Pieces
905862000	48" U-Channel
905863000	54" Trim Pieces
905864000	48" L-Brackets
905865000	32" Trim Pieces
905866000	54" U-Channel
905867000	54" L-Channel

RV accessories

Kwikee Cargo Tray Trim Kits - Super Slide II Trim

These trim kits are specifically designed to be used with Super Slide II. Order trim kit to desired compartment width less 4". Trim kit includes (2) end trim pieces, jig kit and (3) mid-rails. You will need to add plywood and carpet.

part no.	description	Trim Kit End Piece Width	Compartment Opening
905849017	Super Slide II Trim Kit	17"	21"
905849019	Super Slide II Trim Kit	19"	23"
905849021	Super Slide II Trim Kit	21"	25"
905849023	Super Slide II Trim Kit	23"	27"
905849024	Super Slide II Trim Kit	24"	28"
905849025	Super Slide II Trim Kit	25"	29"
905849027	Super Slide II Trim Kit	27"	31"
905849030	Super Slide II Trim Kit	30"	34"
905849032	Super Slide II Trim Kit	32"	36"
905849033	Super Slide II Trim Kit	33"	37"
905849035	Super Slide II Trim Kit	35"	39"
905849036	Super Slide II Trim Kit	36"	40"
905849037	Super Slide II Trim Kit	37"	41"
905849039	Super Slide II Trim Kit	39"	43"
905849041	Super Slide II Trim Kit	41"	45"
905849042	Super Slide II Trim Kit	42"	46"
905849044	Super Slide II Trim Kit	44"	48"
905849047	Super Slide II Trim Kit	47"	51"
905849048	Super Slide II Trim Kit	48"	52"
905849051	Super Slide II Trim Kit	51"	55"

Electric Steps

Manufactured from heavy-gauge steel and designed to handle up to 750 lbs. They feature 3/4" solid steel drive rods and stainless steel bushings. The powder coat finish provides a corrosion resistance over bare metal and an aesthetically pleasing look.

part no.	description	series	rise	run	bolt pattern
single thread steps					
902809025	23-3/4" tread, IMGL, 9510 control, switch kit #905325000	28	7"	10"	6.5" x 22"
903609025	30" tread, IMGL, 9510 control, switch kit #905325000	36	5"	10.75"	8" x 26"
double thread steps					
903209025	24" tread, IMGL, 9510 control, switch kit #905325000	32	7"	9"	8" x 22"
903409025	30" tread, 9510 control switch kit #905325000	34	7"	9"	8" x 26"
triple thread steps					
902409000	30" tread, contains step control, no switches	24	8"	9"	8" x 26"
902509000	24" tread, contains step control, no switches	25	8"	9"	8" x 22"

RV Step Motor Kits/Update Kits

The upgrade kit includes the IMGL (Integrate-Motor-Gearbox-Linkage), control unit, door switch and is designed to update your original step motors on all 1999-2005 year step models. Kits are available in A, B or C linkage. To determine the proper kit needed, locate the step series on your step identification plate. Note: Door switch must be changed with kit upgrade.

part no.	description	step series
909770000	"A" linkage, IMGL and control unit	22, 23, 30, 32, 33-36, 38, 40
909772000	"B" linkage, IMGL and control unit	28, 31, 37, 39
909776000	IMGL and control unit	25



Scan for pricing or go to www.delcity.net/catalogpricing



905849017



902809025



903209025



902409000

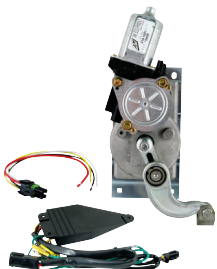

909770000



1101428

Kwikee Motion - 2006 to Current IMGL - IMGL Replacement Step Motor

The IMGL (Integrate-Motor-Gearbox-Linkage) replacement motor can be used to replace IMGL's on steps manufactured from 2006 to current model years. To determine the proper kit needed, locate the step series on your step identification plate.

part no.	description	step series
1101428	motor and screws for new IMGL steps	22, 23, 26, 28, 30-40, 42, 44, 47



Scan for pricing or go to www.delcity.net/catalogpricing



1101425

Kwikee Linkages - 2006 to Current (IMGL) - IMGL Gear/Linkage Replacement Kit

The IMGL gear/linkage is a direct replacement for steps manufactured from 2006 to current model years or those already with IMGL upgrade kits. This is the replacement gear and linkage and does not include the IMGL motor or IMGL 9510 control unit.

part no.	description	step series
1101425	gear & linkage kit A	22, 23, 30-36, 38, 40
1101426	gear & linkage kit B	28, 31, 37, 39
1101427	gear & linkage kit C	26



909510000

Kwikee 9510 Step Control Unit - 2006 to current (IMGL) - IMGL 9510 Step Control Unit

The IMGL (Integrated-Motor-Gearbox-Linkage) 9510 step control unit is designed to work on all step series manufactured after 2006 model years. Kit works only with a normally open door switch. To determine the proper kit needed, locate the step series on your step identification plate.

part no.	description	step series
909510000	control for IMGL/9510 control steps	22, 23, 26, 30-40, 42, 44, 47



905205000

Cotter & Clevis Pin

A low cost option for simple cotter and clevis pin kit replacement. For steps made 2006 to current.

part no.	description
905205000	cotter & clevis pin

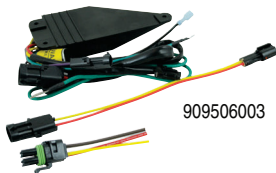

909506003

Kwikee 9510 Step Control Unit - Prior to 2006 (PRE - IMGL) - 9510 Control Unit (Pre-IMGL)

The 9510 control unit is designed to replace the control units on the "pre-IMGL" step units that were manufactured from 1999 to 2005. It is designed to be used with the normally closed white magnetic door switches.

part no.	description
909506003	control unit for pre-IMGL/9510



909520000

Kwikee Motor - Prior to 2006 - Motor Replacement Kit (Pre-IMGL)

This motor replacement kit is designed for pre-IMGL step units that were manufactured from 1999 to 2005 model years. The kit includes wire connection harness.

part no.	description
909520000	motor replacement kit



909534000

Kwikee Linkage - Prior to 2006 - Linkage Kit (Pre-IMGL)

These linkage kits are designed to replace linkage on pre-IMGL step units that were manufactured from 1999 to 2005 model years and can only be used with 909502000 or 3000 motors. The kit includes the linkage, coupler and cover.

part no.	description
909534000	linkage kit A
909533000	linkage kit B
909532000	linkage kit C

RV accessories

Plunger Door Switch

A magnetic switch that operates steps. The plated switch is hinge mounted.

part no.	description
905302000	plunger door switch



Magnetic Door Switches

Offered in several different styles. Choose from either round or rectangular versions. Both are manufactured in neutral white. Switch is used to automatically raise or lower steps.

part no.	description	ID
905306000	rectangle magnetic door switch	—
905312000	mini rectangle magnetic door switch	—
905307000	round magnetic door switch	3/8"
905314000	mini round magnetic door switch	3/4"



Step Light

Helps illuminate the stairs when the sun goes down. Light can be used with any series of stairs.

part no.	description
909004000	under step light



4-way Harness Plugs

Pre-wired harnesses with male Weatherpack connectors. Harness is manufactured with 12" of one red 10-gauge and three 16-gauge wire.

part no.	description
909306000	wiring harness

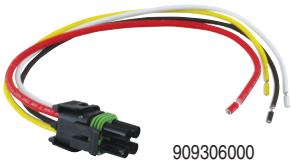

Step Tread

Replaces existing worn-out step treads. All styles feature an adhesive back with non-skid tread.

part no.	description	ID
909342000	glow in the dark step tread	6"D x 21"W
909334000	non-skid step tread	8"D x 25"W
909331000	non-skid step tread	6"D x 21"W
909540000	non-skid step tread-yellow	8"D x 33"W
909335000	non-skid step tread	8"D x 33"W

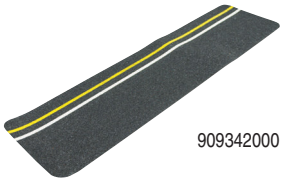

The Test Control Kit

Provides diagnostics for RV step service. It isolates step function from RV power and wiring, allowing you to pin point the problem. Replace only the parts you have to.

part no.	description
909518000	KWIK TEST control unit test box



Spray Lube

A penetrating aerosol fluid that changes to a tough, protective grease in minutes. The lube helps prevent steps from rusting and helps reduce wear.

part no.	description	size
905068000	lube, single can	11 oz
905069000	lube, twelve can case	11 oz



Scan for pricing or go to www.delcity.net/catalogpricing



CREDIT APPLICATION

please fax to 800.431.1293 or 262.293.7021

account no. (if current customer) _____ **contact / buyer:** _____

company name _____ email address _____
address _____
city _____ state _____ zip _____
phone _____ fax _____

check one: individual partnership corporation **Dun & Bradstreet no.** _____

debtor (individual and partnership only) _____ title _____
years in business (required) _____ no. of employees (required) _____

taxable yes no **tax rate:** _____% **If NO, please fax tax exemption certificate**

trade references please provide fax numbers

name _____ phone _____
address _____ city _____ state _____ zip _____ fax _____

name _____ phone _____
address _____ city _____ state _____ zip _____ fax _____

name _____ phone _____
address _____ city _____ state _____ zip _____ fax _____

name _____ phone _____
address _____ city _____ state _____ zip _____ fax _____

bank reference please provide fax number

name _____ phone _____
address _____ city _____ state _____ zip _____ fax _____

Applicant's signature attests to the company's financial responsibility, ability and willingness to pay invoices in accordance with the terms and condition of sale. In the event that account is not paid within the terms of **Net 30 from the date of the invoice**, orders are subject to being held until payment is received to bring account current. In the event that the account passes 90 days past due, the undersigned is subject to being placed for collections and assessed an interest of 18% per annum, as well as all costs of collections, including reasonable attorney's fees, if collected by law or through our collection agency. **A \$30.00 charge will be assessed for all returned checks.** If an account remains unused for 6 months a new credit application must be resubmitted.

print name: _____ date: _____

by: _____ title: _____

N85 W12545 Westbrook Crossing, Menomonee Falls, WI 53051

Free Shipping Over \$99

1-2 Day Delivery

No Minimum Order Size

Efficient Global Fulfillment

TERMS AND CONDITIONS OF SALE

Unless otherwise agreed to by Del City in writing, the following terms and conditions ("Agreement") apply to all purchases of Products. By placing an order for Products, you accept and agree to be bound to this Agreement. If you have placed an order, but do not wish to be bound to this Agreement, then you must either (i) promptly cancel such order in accordance with the Cancellation Policy (as defined below), or (ii) return the order in accordance with the Return Policy (as defined below).

DEFINITIONS. "Del City" means Del City, a business unit of Power Products,. "Buyer" or "you" means you and/or any of your affiliates that place an order for Products. "Products" includes Standard Products and Special Products. "Standard Products" are products (i) that have not been modified especially for a Buyer, and (ii) are available to the general public for purchase from Del City. "Special Products" are products that (i) are not a Standard Product, (ii) are a custom product or a modification of a Standard Product done at the request of or especially for a Buyer, or (iii) have been marked or labeled according to a Buyer's specifications.

ORDERS. All orders are subject to acceptance by Del City, which acceptance will be indicated by (i) written confirmation, (ii) electronic confirmation, or (iii) fulfillment and shipment of such order. Products must be ordered in standard pack quantities where applicable. Del City reserves the right to supply less than the quantity ordered of any Product, at any time and without notice. All orders shall be deemed to be fully accepted by Buyer unless Del City receives written notification to the contrary within fourteen (14) days of the invoice date of such order.

PRICES. All orders for Standard Products will be invoiced at the price in effect on the date the order was accepted, and all orders for Special Products will be invoiced at the price in effect at the time of shipment. All prices are subject to change without notice and are subject to shortages in materials or resources and increases in the cost of manufacturing. Taxes and shipping and handling charges are not included in Product prices. Unless otherwise agreed to by Del City in writing, all costs, fees and expenses associated with the shipment of Products or the insurance of such products while in transit shall be paid by Buyer, and will be calculated and added to the order prior to shipment.

TAXES AND FEES. All taxes, assessments, fees, and charges applied or imposed by any government relating to the sale, delivery, shipment or use of Products will be added to the purchase price of Products and will be paid by Buyer, except to the extent that Buyer provides Del City with an acceptable tax exemption certificate.

Note: For shipments to Illinois, Del City does not collect tax on freight; however, applicable sales tax on freight charges are paid by Del City to the state of Illinois.

Use Tax Notice: Del City is not required to and does not collect sales or use tax in certain states, such as Kentucky. Buyer may be subject to use tax under applicable state law unless the purchase is exempt from taxation; however, a purchase may not be exempt merely because it is made over the Internet, by catalog, or by other remote means. Certain states require their residents to report all purchases of tangible personal property that are not taxed by Del City and pay use tax on such purchases unless exempt under applicable law. Residents of Kentucky and other states where use tax rules may apply should refer to their state's sales and use tax laws for more information.

DELIVERY. Unless otherwise agreed to by Del City in writing, all orders will be delivered FOB shipping point. Scheduled shipping dates are estimates, and subject to change without notice. Unless otherwise agreed to by Del City in writing, actual delivery dates are not of the essence. Del City will have no liability to Buyer or any third party with regard to any delay in delivery, regardless of the reason.

CANCELLATION POLICY. No orders which have been received by Del City may be cancelled or revised by Buyer except with Del City's prior written consent and upon payment of reasonable cancellation charges compensating Del City for all costs incurred in work done and material purchased. Del City reserves the right (i) to determine what constitutes reasonable cancellation charges, and (ii) to cancel any order at any time if Buyer becomes insolvent or is in breach of any applicable law or any term of this Agreement. Orders for Special Products are non-cancellable.

TITLE AND RISK OF LOSS. Title to each order for Products shall pass from Del City to Buyer upon Del City's tender of such order to the initial carrier. Loss or damage that occurs during shipping shall be Buyer's responsibility. Acceptance of an order from the final carrier constitutes a waiver of any claims against Del City for delay, damage or losses arising from such order.

CREDIT AND PAYMENTS. Payment terms are net 30 days. Visa, MasterCard, American Express and Discover/Novus payments are accepted. No charges will be made to your credit card until the product has been shipped. All payments must be in U.S. dollars. Invoices are due and payable within the time period noted on Buyer's invoice, or if not noted, then within thirty (30) days, measured from the date of the invoice. Account credit may be approved for qualified Buyers, subject to continuing credit approval by Del City. Del City reserves the right to withdraw credit at any time and for any reason. Del City may invoice parts of an order separately or may invoice purchases of Products in one invoice.

OVERDUE ACCOUNTS. Timely payment for all invoices is of the essence. Del City reserves the right to charge Buyer a late penalty of 1.5% per month applied against undisputed overdue amounts, or the maximum rate permitted by law. Del City shall have the right to set-off and deduct from any credit balance any sums owed from Del City. If Buyer fails to make payment in accordance with the payment terms specified by Del City, Del City may, without any liability to Buyer, defer shipments until such payment is made, or may, at its option, cancel all or any part of the unshipped order. Buyer shall be liable to Del City for all collection expenses, including reasonable attorney's fees and court costs, incurred by Del City in attempting to collect any amounts due from Buyer.

CREDIT BALANCES. Unless otherwise agreed to by Del City in writing, Buyer must use any credit balances that have been issued by Del City within one (1) year of issuance. IF NOT APPLIED OR REQUESTED WITHIN SUCH PERIOD, ANY BALANCE REMAINING WILL BE SUBJECT TO CANCELLATION, AND DEL CITY SHALL HAVE NO FURTHER LIABILITY WITH RESPECT THERETO.

CORRECTIONS. Del City is not responsible for pricing, typographical, or other errors in any offer, catalog, price list or quotation, and reserves the right to cancel orders arising from such errors.

SPECIAL PRODUCTS. All drawings, designs or specifications for Special Products must be mutually agreed upon in a written document signed by both parties. Orders for Special Products are non-cancellable and nonreturnable. If Buyer rejects any delivery of Special Products, in whole or in part, Buyer is still liable for the full purchase price of such order.

RETURN POLICY. Subject to certain restrictions, new, unused, and unopened Standard Products may be returned to Del City after receiving a Return Merchandise Authorization (RMA) from Del City ("Authorized Returns"). To obtain an RMA, contact your Del City Buyer Service Representative. Authorized Returns received more than 30 days after initial delivery are subject to a minimum 20% restocking fee. Authorization will not be given for the return of Products (i) which are discontinued Products, (ii) which were not invoiced within the previous twelve (12) month period, or (iii) which are Special Products. Unauthorized returns may be refused and/or returned freight collect. Authorized Returns must be in their original or equivalent packaging, and, unless otherwise agreed to by Del City in writing, Buyer is responsible for risk of loss and shipping and handling fees for Authorized Returns. The "Return Value" for Authorized Returns shall be the lesser of (i) the prevailing fair market value of such products at the time the RMA is issued or (ii) Buyer's original purchase price for the products, adjusted for bundling and promotional pricing, if applicable. The Return Value shall be paid in the form of a credit to Buyer's account to be used for future purchases of Products. Special Products and discontinued Standard Products are nonreturnable.

DISCONTINUED PRODUCTS. Del City may modify or discontinue Products at any time without prior notice to Buyer. A change in a Product may occur after a Buyer places an order but before Del City ships the Products. As a result, the Products a Buyer receives might display minor differences from Products requested in a Buyer order. However, modified or substituted Products will meet or exceed all material specifications of the original Products requested in such order. Discontinued Standard Products are nonreturnable.

LIMITED WARRANTY. Subject to certain exclusions and limitations, Del City warrants that at the time of shipment, all Products will be free of defects in material and workmanship. This warranty does not cover ordinary wear and tear, abuse, misuse, overloading, alteration or Products which have not been installed, operated or maintained in accordance with their intended use. The applicable warranty period for all Products is the 30-day period following date of purchase by Buyer, except as expressly covered by a separate written agreement signed by both parties. No warranty will be honored unless an invoice or other proof of the purchase date is provided to Del City. Warranty claims received after the applicable warranty period will not be honored. When a warranty claim arises, Buyer must contact Del City directly. If the defect comes under the terms of this limited warranty, Del City will arrange, at its option, one of the following: (i) the Product will be repaired by Del City authorized personnel, (ii) Del City will replace the Product, or (iii) Del City will refund the applicable portion of the purchase price

LIMITATION OF LIABILITIES. The remedy of repair, replacement or refund is Buyer's exclusive remedy for breach of the foregoing limited warranty. THE FOREGOING WARRANTY IS EXCLUSIVE AND IS IN LIEU OF ALL OTHER EXPRESS AND IMPLIED WARRANTIES WHATSOEVER, INCLUDING BUT NOT LIMITED TO IMPLIED WARRANTIES OF MERCHANTABILITY AND FITNESS FOR A PARTICULAR PURPOSE. IN NO EVENT SHALL DEL CITY BE RESPONSIBLE FOR INCIDENTAL, SPECIAL, OR CONSEQUENTIAL DAMAGES. Buyer is solely responsible for determining the suitability of Products for Buyer's use or resale, or for incorporating them into articles or using them in Buyer's application. Buyers who are distributors (i) are authorized to extend the foregoing limited warranty to its original purchasers in connection with sales of Products, provided that such Products shall not have been altered by such distributor, and (ii) shall be full responsible for any warranties such Buyer makes to its customers, which may be more broad or more extensive than Del City's limited warranty. Del City's total liability for any and all claims arising out of or in connection with this Agreement in any 12-month period shall not exceed the total amount paid by Buyer during the prior 12 months of this Agreement for the specific Product subject to any warranty claim.

GOVERNMENT CONTRACTS. Products are commercial items as defined in Federal Acquisition Regulation (FAR) 2.101. If Buyer sells Products to any government, or to a government prime contractor or subcontractor, Buyer shall be solely and exclusively liable for compliance with all government acquisition statutes and regulations. Del City makes no representations, certifications, or warranties whatsoever about compliance with government acquisition statutes and regulations, including, without limitation, those that may relate to pricing, quality, origin or content, and specifically rejects the flow down of all FAR clauses not required to be included in a subcontract for commercial items.

LEGAL COMPLIANCE. Buyer agrees to comply with all applicable U.S. and foreign laws, regulations, orders and requirements pertaining to the purchase and sale of Products, their export from the U.S., and their import into the country of destination. Without limiting the generality of the foregoing, Buyer acknowledges and agrees to comply with (i) all U.S. export licensing laws and regulations, (ii) all restrictions on the sale or other transfer of Products to prohibited parties, countries or end-users, and (iii) all restrictions on the sale or other transfer of Products for a prohibited end-use. In addition, Buyer acknowledges and agrees to comply with the U.S. Foreign Corrupt Practices Act, the UK Bribery Act and all other applicable antibribery laws and regulations.

DUTY TO DEFEND. Buyer agrees to defend, hold harmless and indemnify Del City and reimburse Del City for all claims, taxes, penalties, interest, costs, assessments and expenses that arise as a result of or in connection with any inadequacy or invalidity of any tax exemption certificate submitted by Buyer or any act, omission or misrepresentation of Buyer or any of its affiliates, employees, agents, contractors, Buyers, or representatives, which gives rise to any breach of this Agreement.

FORCE MAJEURE. Del City shall not be liable in any way for any delay or cancellation in shipment, manufacture or performance due to acts of God, war, riot, insurrection, terrorism, labor difficulties, accident, acts of civil or regulatory authorities, fires, floods, quarantine restrictions, plant conditions, delays in transportation, shortages of fuel, labor or any other condition beyond Del City's control.

EXCLUSIVE AGREEMENT. This Agreement constitutes the entire agreement between Buyer and Del City with regard to Buyer's purchase of Products, and supersedes all prior oral and written understandings, communications, or agreements between the parties. Del City objects to and rejects any additional or different terms or conditions in any form tendered by Buyer, including expressly rejecting any provisions that dictate that Buyer's terms control or any additional or different provisions in a Buyer's electronic business portal. Del City's failure to object to any provisions or terms from Buyer will not be a waiver or amendment of any of the provisions of this Agreement. If Buyer's purchase order or other correspondence contains terms or conditions in addition or contrary to this Agreement, Del City's acceptance of Buyer's order shall not be construed as assent to any such additional terms and conditions and will not constitute a waiver by Del City of any of this Agreement. In the event this Agreement conflicts with any previous agreement or any other purchase documents between the parties, then this Agreement shall take precedence.

GOVERNING LAW. This Agreement and any claim, dispute, or controversy arising from or relating to this Agreement or Buyer's purchase of any Products shall be governed by the laws of the State of Wisconsin, without regard to its conflict of laws rules. The parties specifically waive application of the UN Convention on Contracts for the International Sale of Goods. Buyer irrevocably consents to personal jurisdiction of the state and federal courts in and for Waukesha, County, Wisconsin, and irrevocably waives any claim it may have that any proceedings brought in such courts have been brought in an inconvenient forum.

MISCELLANEOUS. No amendment to or modification of this Agreement, in whole or in part, will be valid or binding unless it is in writing and executed by authorized representatives of both parties. If any provision of this Agreement should be found to be void or unenforceable, such provision will be stricken or modified, but only to the extent necessary to comply with the law, and the remainder of this Agreement will remain in full force and will not be terminated. No course of dealing between the parties shall amend, modify or supplement any of the provisions hereof. No waiver by Del City of a breach of any term of this Agreement shall be construed as a waiver by Del City of any other breach of this Agreement. Del City reserves the right to update this Agreement at any time; however, Buyer's rights and obligations shall be as provided in the version of this Agreement provided to Buyer or made available to Buyer at the time of its purchase of Products. Buyer shall not assign any order or any interest herein without the prior written consent of Del City. Any actual or attempted assignment without Del City's prior written consent shall entitle Del City to cancel such order upon notice to Buyer. Notices to Del City should be in writing sent by tracked next-day delivery service to: Del City, N85 W12545 Westbrook Crossing, Menomonee Falls, Wisconsin, 53051. All rights, remedies and powers of Del City are cumulative and may be pursued or enforced in any manner or order.

Del City Terms of Sale - Revision Date: 02.20.2014





N85 W12545 Westbrook Crossing
Menomonee Falls, WI 53051
800.654.4757

www.delcity.net

Free
Shipping
Over \$99

1-2 Day
Delivery

No Minimum
Order Size

Efficient
Global
Fulfillment

800.654.4757

f: 800.431.1293

www.delcity.net

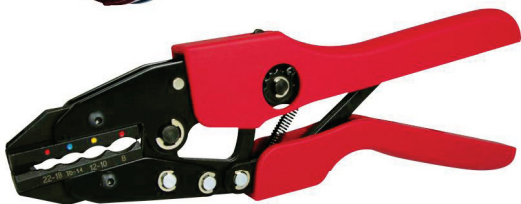

Part No. DC2015